

User Manual

Thanks for purchasing the LCD program box G2, please read this manual carefully before using it. The ZTW Multifunction LCD G2 program box G2 is the equipment that integrates multiple functions, it is small to carry and convenient to set parameters for ESC(Electronic Speed Controller).

FEATURES

1. Working as an individual device to set the parameters for the ESC.
2. Working as a Lipo battery voltmeter to measure the voltage of the whole battery pack and each cell.
3. For the ZTW ESC with data returning feature, it can display real-time data including: voltage, current, input throttle, output throttle, RPM, battery power, MOS temperature and motor temperature.
4. For the ZTW ESC with data logging feature, it can read the data including: maximum RPM, minimum voltage, maximum current, external temperature, and maximum temperature.
5. PWM throttle signal detection: Identify and display the input throttle pulse width and frequency.
6. ESC/Servo Tester: It works like remote control to adjust the speed for ESC/servo by press the program box's button.
7. The LCD program box can be upgraded by the mobile App via the ZTW bluetooth module.

SPECIFICATION

- Size: 84*49*11.5mm
- Weight: 40g
- Power supply: DC5~12.6V

SUITABLE FOR THE FOLLOWING ESC

1. Beatless G2, Mantis G2, Skyhawk
2. Shark G2, Seal G2, Dolphin

DESCRIPTION OF EACH BUTTON AND PORT

1. **ITEM**: Change the programmable items circularly.
2. **▽**: Change the programmable items circularly in positive direction.
3. **△**: Change the programmable items circularly in negative direction.
4. **OK**: Save and send the current parameters into the ESC.
5. **ESC**: Use programming line to connect this port with programming port of ESC.
6. **Batt**: Programming box power supply input port.
7. **Battery Check**: Connect this port with the balance charging connectors of the battery.

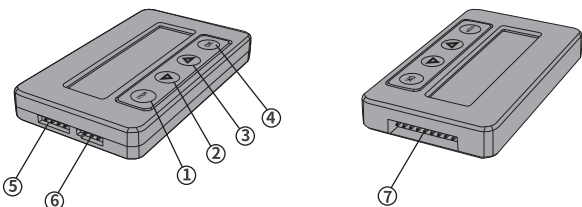

INSTRUCTIONS

A. Working as an individual device to set the parameters for the ESC

1. Disconnect the battery from the ESC.
2. Select the corresponding connection method, and connect the ESC with LCD program box.
 1. If the programming line of ESC shares a same line with throttle line, then unplug throttle line from receiver and plug into "ESC" port of LCD program box correspondingly. (See Diagram 1)
 2. If the ESC has independent programming port, then using programming line to connect programming port of ESC with "ESC" port of LCD program box. (See Diagram 2)
3. Connect the ESC to battery.
4. If the connection is correct, LCD program box shows initial screen,

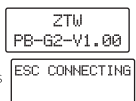

press "ITEM" or "OK" button on the LCD program box, the screen shows

shows the 1st programmable item after a few seconds, which means LCD program box connects with ESC successfully. Press the "ITEM" "▽" and "△" button to select the options, press "OK" button to save data.

Diagram 1

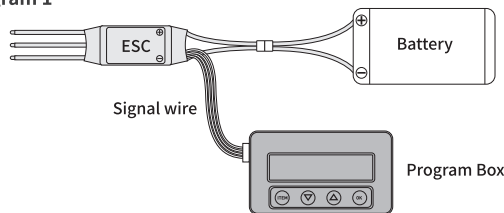
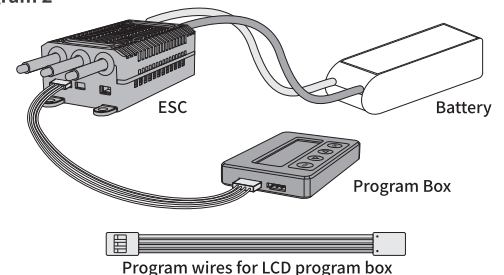

Diagram 2



Note:

1. Reset the ESC by the LCD program box

When the connection between ESC and LCD program box is successfully established, press "ITEM" button for several times until the "Restore Default" is displayed, press "OK" button, then all programmable items in the current profile are reset to factory default options.

2. Read the data logging of ESC by LCD program box

For the ESCs with data logging function, the following data can be displayed after the menu of "Restore Default": maximum RPM, minimum voltage, maximum current, external temperature, and maximum temperature. (ESC without data logging function will not display these data)

3. Check the ESC running data in real time by LCD program box

For the ESCs with data returning function, when the connection between ESC and LCD program box is successfully established:

1. The LCD program box can display the following data in real time: voltage, current, input throttle, output throttle, RPM, battery power, MOS temperature and motor temperature.
2. If the ESC has errors, the LCD program box will display the current error circularly. The errors are as below:

SC Protection	Short circuit protection
Break Protection	Motor wire brake protection
Loss Protection	Throttle loss protection
Zero Protection	Throttle is not in zero position when powered up
LVC Protection	Low voltage protection
Temp Protection	Temperature protection
Start Protection	Start locked rotor protection
OC Protection	Over current protection
PPM_THR ERROR	The PPM throttle is not in the range
UART_THR ERROR	The UART throttle is not in the range
UART_THR LOSS	UART throttle loss
CAN_THR LOSS	CAN throttle loss
BAT_VOT ERROR	The battery voltage is not in the range

B. PWM throttle signal detection

When the PWM signal device such as the receiver is in normal working state, connect the receiver and LCD program box, Press and hold the buttons **△ ▽** for 3 seconds at the same time, Then select "Input Signal", it can identify and display the input throttle pulse width and frequency.

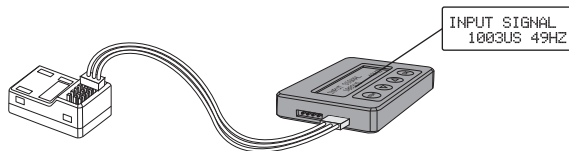

C. ESC/Servo Tester

It works like remote control to adjust the speed for ESC/servo by press the program box's button.

1. Press and hold the buttons **△ ▽** for 3 seconds at the same time, then select "Output Signal".
2. Press the button respectively **△ ▽**, the throttle will be increased or decreased in units of "1us", long press the **△** or **▽** button for about 3 seconds to quickly increase or decrease the throttle.
3. Press the "ITEM" button, the throttle will decrease in units of "100us", press the "OK" button, the throttle will increase in units of "100us".

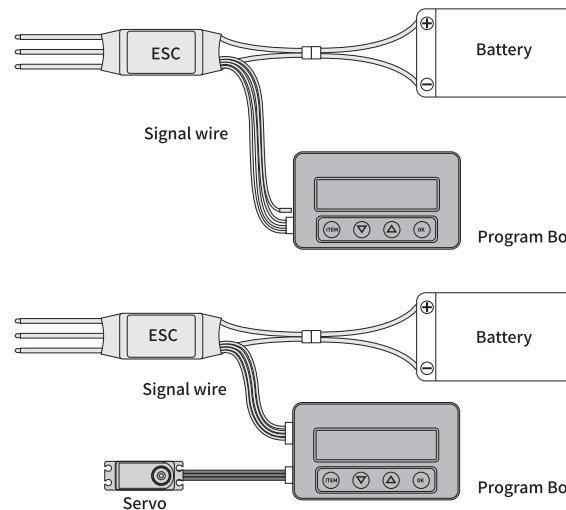

D. Working as a Lipo battery voltmeter to measure the voltage of the whole battery pack and each cell

1. Battery: 2-8SLi-Polymer/Li-Lon/LiHV/Li-Fe
2. Precision: ±0.1V
3. Usage: Plug the battery balance charge connector into the "BATTERY CHECK" port of the LCD program box separately, (Please make sure that the negative pole points to the "-" symbol on the program box).

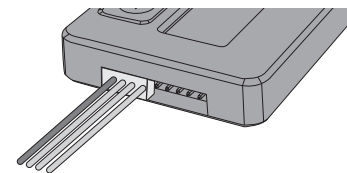

ZTW PB-G2-V1.00	BATTERY VOLTAGE 11.31V	1: 3.74V 2: 3.76V 3: 3.81V 4: 0.00V	5: 0.00V 6: 0.00V 7: 0.00V 8: 0.00V
--------------------	---------------------------	--	--

E. Update the firmware of LCD program box

The LCD program box should be updated because the functions of ESC are improved continuously, the method is as follows:

1. Provide power for LCD program box by ESC, battery or external power supply device, the power supply range is 5-12.6V.
2. Connect the ZTW Bluetooth module to the "ESC" port of the LCD program box.
3. Download ZTW APP and install it on your phone, after install it successfully, open your phone's bluetooth, find "ZTW-BLE-XXXX", then click "Connect".
4. After the connection is successful, select "Firmware", then select "Firmware Update".
5. Select the latest firmware and click "OK" to upgrade.
6. Wait for a few seconds until the interface displays "Upgrade Successful"

说明书

尊敬的客户，感谢您购买和使用本产品，使用前请认真阅读此说明书！

中特威多功能LCD编程卡G2是一款集多种功能于一身的编程卡，LCD液晶屏幕显示，功能丰富，直观易懂，迷你尺寸，小巧便捷，非常方便携带在外场使用。

产品特点

1. 作为独立的设备，利用自带的LCD(液晶屏幕)显示电调参数，进行参数设定。
2. 将电池连接编程卡右侧接口，检测电池整体电压及每节电池的单体电压。
3. 针对中特威有数据回传功能的电调，能够显示实时数据，包括：电压、电流、输入油门、输出油门、转速、电池电量、MOS温度与电机温度。
4. 针对中特威有数据记录功能的电调，可读取数据记录值，包括：最大转速、最小电压、最大电流、外部温度、最高温度。
5. PWM油门信号检测：识别并显示输入油门脉宽及频率。
6. 油门调速器：通过编程卡按钮，调整油门信号，对舵机、电调等设备进行油门控制。
7. 可通过中特威蓝牙模块连接手机App对编程卡进行升级。

规格

- 外形尺寸: 84*49*11.5mm
- 重量: 40g
- 供电电源: DC5-12.6V

使用范围

1. Beatles G2、Mantis G2、Skyhawk系列航模无刷电调。
2. Shark G2、Seal G2、Dolphin系列船模无刷电调。

按键与各插头功能说明

1. **ITEM**: 循环切换编程项目。
2. **▽**: 正方向循环切换某编程项目的参数值。
3. **△**: 反方向循环切换某编程项目的参数值。
4. **OK**: 保存并发送当前所选的参数值到电调。
5. **ESC**: 信号线接口，电调的编程线与此接口相连。
6. **Batt**: 编程卡供电输入接口。
7. **Battery Check**: 电池检测接口，用于检测电池整体电压及每节电池的单体电压。

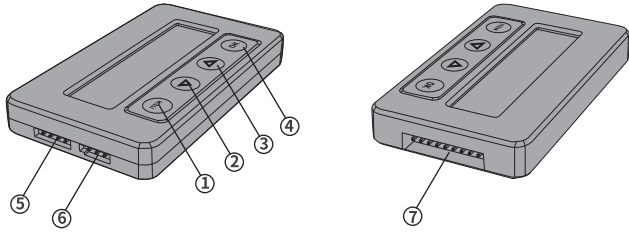

使用说明

一、作为独立设备对电调进行参数设定

1. 断开电调电源。
2. 选择相应的连线方式，将电调与编程卡连接好。
 - ① 如果电调编程线与油门线复用，则从接收机上拔出电调油门线，按照正确的顺序插入LCD编程卡的“ESC”插口中。(请看图1)
 - ② 如果电调有独立的编程口，则使用编程连接线将电调的编程口与LCD编程卡的“ESC”端口连接好。(请看图2)
3. 将电调接上电池。
4. 如果连接正确，LCD屏幕则显示出 开机界面，此时按压“ITEM”或“OK”键，编程卡将显示界面 ，等待几秒后，显示第一个参数设置界面，则表示编程卡与电调连接成功。使用“ITEM”、“▽”与“△”按键更改参数，按“OK”键保存参数。

图1



图2



注:

1. 使用LCD编程卡将电调参数恢复成出厂默认值

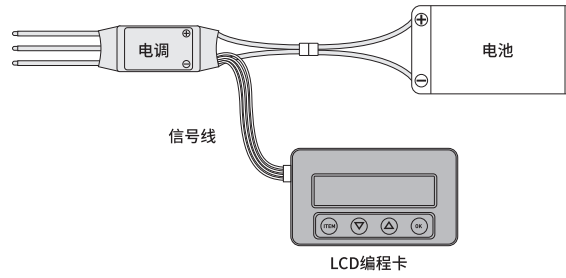
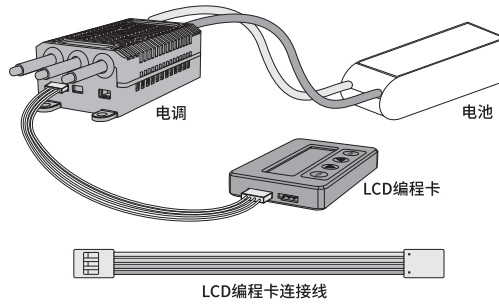
在电调和LCD编程卡联机状态下，多次按“ITEM”键，直至显示“Restore Default”，按OK键，则将电调的所有参数恢复成出厂默认值。

2. 使用LCD编程卡读取电调数据记录值

针对中特威有数据记录功能的电调，在菜单“Restore Default”后面，可显示以下数据：最大转速、最小电压、最大电流、外部温度、最高温度。(无数据记录功能的电调，则不会显示这些数据)

3. 使用LCD编程卡实时查看电调运行数据

针对中特威有数据回传功能的电调，在电调和LCD编程卡联机状态下：

- ① LCD编程卡能够实时显示以下数据：电压、电流、输入油门、输出油门、转速、电池电量、MOS温度与电机温度。
- ② 如果电调出现错误状态，LCD编程卡会循环显示当前错误，错误对应如下：

SC Protection	短路保护
Break Protection	电机断线保护
Loss Protection	油门丢失保护
Zero Protection	上电油门未归零保护
LVC Protection	低压保护
Temp Protection	温度保护
Start Protection	启动堵转保护
OC Protection	电流保护
PPM_THR ERROR	PPM油门不在范围
UART_THR ERROR	UART油门不在范围
UART_THR LOSS	UART油门丢失
CAN_THR LOSS	CAN油门丢失
BAT_VOT ERROR	电池电压不在范围

二、PWM油门信号检测

连接PWM输出信号设备与LCD编程卡，且在联机状态下，同时长按 **△ ▽** 键3秒进入调试界面，选择“Input Signal”编程卡识别并显示输入油门脉宽及频率。

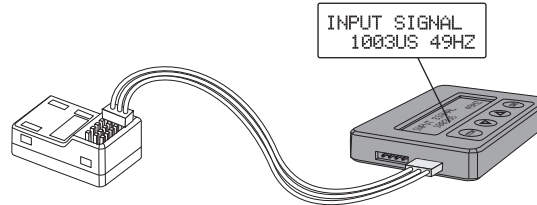

三、油门调速器

通过编程卡按钮，调整油门信号，对舵机、电调等设备进行油门控制。

- ① 同时长按 **△ ▽** 键3秒进入调试界面，选择“Output Signal”。
- ② 分别按下 **△ ▽** 键，油门宽度将以“1us”为单位进行加减，长按 **△** 或 **▽** 键3秒左右可对油门进行快速加减。
- ③ 按下“ITEM”键，油门宽度将以“100us”为单位进行减少，按下“OK”键，油门宽度将以“100us”为单位进行增加。

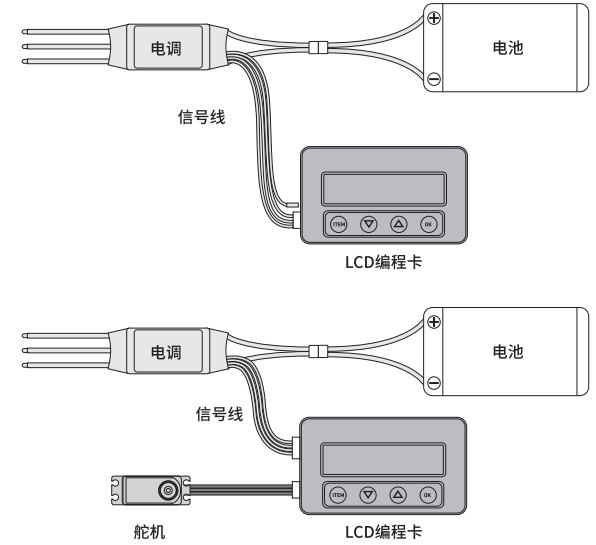

四、作为电池电压检测器 (Monitor)，测量并显示电池组整体电压及电芯单体电压

1. 测量范围: 2-8SLI-Polymer/Li-Lon/LiHV/Li-Fe
2. 测量精度: ±0.1V
3. 使用方法: 用电池平衡插头单独插入设定卡“BATTERY CHECK”端口，(电池平衡端口的负极与设定盒外壳的负极符号相对应)，如图。

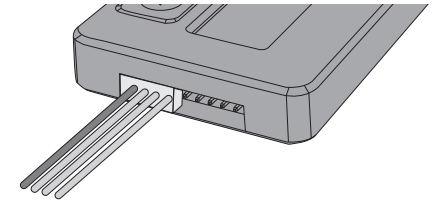

ZTW PB-G2-V1.00	BATTERY VOLTAGE 11.31V	1: 3.74V 2: 3.76V 3: 3.81V 4: 0.00V	5: 0.00V 6: 0.00V 7: 0.00V 8: 0.00V
--------------------	---------------------------	--	--

五、LCD编程卡固件程序更新

因为电调功能持续更新，所以LCD编程卡的固件程序也需随之更新，必要时我们需对LCD编程卡的固件程序进行升级，方法如下：

1. 使用电调、电池或者外部电源设备给LCD编程卡单独供电，供电范围5-12.6V。
2. 将中特威蓝牙模块(需单独购买)跟LCD编程卡“ESC”端口连接。
3. 下载中特威航模APP，打开手机蓝牙，找到“ZTW-BLE-XXXX”，点击连接。
4. 连接成功后，选择“Firmware”，再选择“Firmware Update”。
5. 选择最新固件，点击“OK”进行升级。
6. 等待数秒，直到界面显示“升级成功”即可。

地址: 深圳市宝安区西乡街道九围新村冠锋工业园一栋二楼

电话: +86 755 29120026, 29120036, 29120056

传真: +86 755 29120016

网址: www.ztwoem.com

邮箱: support@ztwoem.com