

OPERATION MANUAL



**2.4GHz
Telemetric
AFHSS**
ADAPTIVE FREQUENCY HOPPING
SPREAD SPECTRUM



LYNX 4S

4 CHANNEL 2.4GHz SURFACE COMPUTER RADIO SYSTEM

Table of Contents

Section 1: Introduction

Introduction.....	04
Safety Precaution.....	04
Lynx 4S Layout.....	06
Changing the Position of the Steering Wheel.....	11
Modifying for Left-Hand Users.....	13
Rubber Grip and Neck Strap.....	13
Receiver.....	14
Receiver Installation.....	16
Receiver Connection Diagrams.....	17
Charging.....	17
Main Display.....	19
Sub Menus.....	20

Section 2: Model Programming

R.E.V (Servo Reverse).....	21
E.P.A (End Point Adjust).....	21
A.T.L (Brake Rate).....	22
A.B.S (Anti-Lock Brake).....	22
ST-EXP (Steering Exponential).....	23
BK-EXP (Brake Exponential).....	24
TH-EXP (Throttle Exponential).....	24
ST-D/R (Steering Dual Rate).....	25
S-TRIM (Sub Trim).....	25
Fail-Safe.....	26
BOOST (Auto Boost).....	27
ST-SPD (Steering Servo Speed).....	27
TH-SPD (Throttle Servo Speed).....	28
TH-MOD (Throttle Mode).....	28
IDL-UP (Idle Up/Down).....	29
Timer (Race Timer).....	29
Countdown Timer.....	30
Lap Timer.....	31
Lap List (Lap Time Listings).....	31
Switch (Switch Functions, Assignments & Settings).....	32
Assignable Switch List.....	33
Function of Switch.....	34
Dial (Radio Dial Functions & Settings).....	35
Dial Function.....	36
Mix (Channel Mixing).....	37
Type of Mixing.....	37
4WS (4 Wheel Steering).....	38
Crawler.....	38

Table of Contents

Section 3: System Programming

ST-ADJ (Steering Adjustments).....	39
TH-ADJ (Throttle Adjustments).....	39
RX-Bind (Receiver Binding).....	40
RF-Scan (Radio Frequency Scanning).....	41
Servo (Servo Monitoring).....	42
Sensor (Telemetry Sensor Setup).....	42
Management (Radio System Management Settings).....	47
Telemetry (Telemetry Display).....	48
Vibration.....	49
Battery (Battery Type Settings).....	49

Section 4: Model Management

Name (Model Naming).....	50
Delete (Model Delete).....	50
Copy (Model Copy).....	51
Change (Active Model Selection).....	51

Section 5: SD Card Management

SD-Name (SD Card Model Naming).....	52
SD-Delete (SD Card Model Delete).....	52
SD-Import (SD Card Model Import).....	53
SD-Export (SD Card Model Export).....	53
Voice (Voice Function).....	54
Music (Music Play).....	54
Warning & Error Messages.....	55

Introduction

Thank you for purchasing the Lynx 4S Radio by Hitec!

As Hitec's latest contribution in outstanding surface radio technology, the four-channel Lynx 4S is equipped with lightning fast 4ms response, 4096 resolution, and Hitec's unique bi-directional, AFHSS (Advanced Frequency Hopping Spread Spectrum) function for use with all popular R/C-operated models. Feature-packed with an easy-to-use interface, the Lynx 4S design promises a more enjoyable and safer R/C experience than ever before.

Prior to using your Lynx 4S 2.4GHz system, it is highly recommended that you read this manual carefully and in full to ensure operation of the unit as intended. It's also a good idea to keep these instructions with your Lynx 4S for easy reference at all times.

Please note that Hitec reserves the right to make production changes during the life of our product lines which may impact the information in this manual.

For the most up-to-date information on this and any other Hitec product, visit our web site at www.hitecrd.com.

Safety Precaution

Flying models can be dangerous if proper safety precautions are not followed as described. Here are a few critical safety suggestions to keep you and others safe.

Do not operate the Lynx 4S during inclement weather.

Do not operate under conditions of poor visibility.

Do not operate your model in close proximity to others wherever their presence could result in personal injury or property damage.

Do not operate R/C boats where passenger boats are present or where swimmers, bathers, or others participating in water activity may be in danger.

Please note that Radio Control Systems are susceptible to interference when high tension power lines, power transmission towers, or power transmission sites are near.

Minors under 19 years of age are encouraged to operate their model under adult supervision.

We strongly recommend that anyone new to R/C solicit guidance from seasoned users or their local R/C shop.

Do not store your R/C system in places exposed to extreme heat (over 40°) or cold (below 10°), or where it can be compromised by direct sunlight, dust, or jarring.

Prior to activating your model, always check your Lynx 4S for a normal response. Double check that your settings are as desired and that your radio is functioning as it should.

Safety Precaution (cont.)

Always check the transmitter's throttle trigger to be sure it rests in a neutral position before powering "ON" your system. Make sure your model's engine is not running when powering down.

Always turn the transmitter power switch on first before turning on either the receiver or speed control. Reverse the order when powering down: be sure to turn off the receiver and speed control first, then power off your transmitter.

Always set up the fail safe function. The fail safe function is a safety feature that minimizes damage by moving the servos to a preset position when reception fails.

When the Lynx 4S is not being used, always remove or disconnect the battery to prevent personal injury or property damage.

Do not drop the battery or subject it to jarring vibrations or extreme temperatures.

Do not leave the radio system or models within the reach of small children.

Leakage from the battery may potentially result in skin burn, loss of sight, and other injuries. If exposed, thoroughly rinse the affected area and contact your doctor for proper treatment response.

Use approved transmitters, receivers, servos, ESCs (electronic speed controls), Ni-MH/Ni-CD batteries and other optional accessories **ONLY**. Hitec is not responsible for issues that arise from the use or misuse of equipment not specified in this instruction manual or our catalog.

Always exercise proper care in the use and storage of your Hitec product. Exposure to vibration, dust, or extreme temperatures may affect its functionality and your safety.

LYNX 4S MANUAL: SECTION I

LYNX 4S Layout

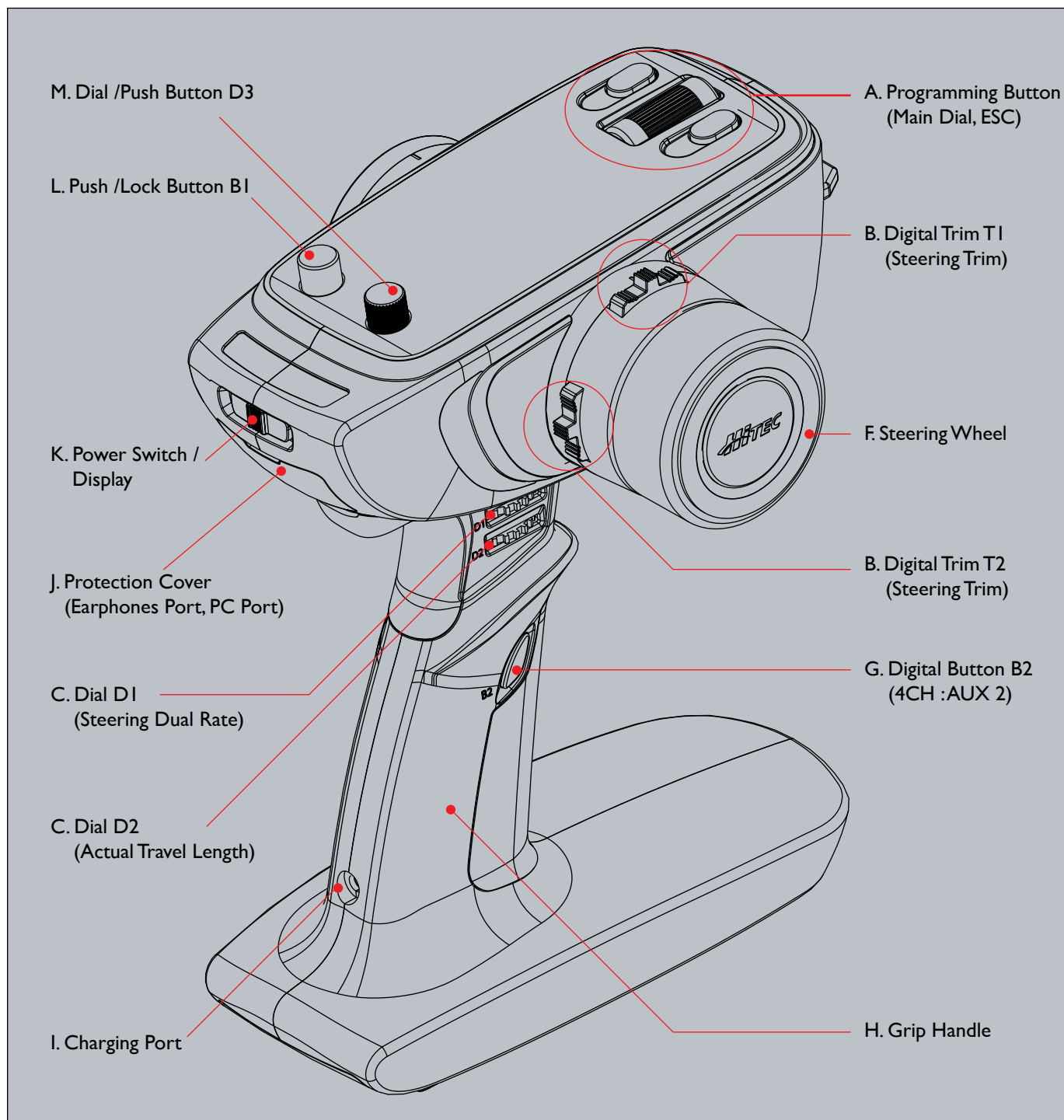

The Switch, Dial, and Digital Trim output on the diagram may differ slightly from those of your own radio. The default settings are pictured above.

LYNX 4S Layout

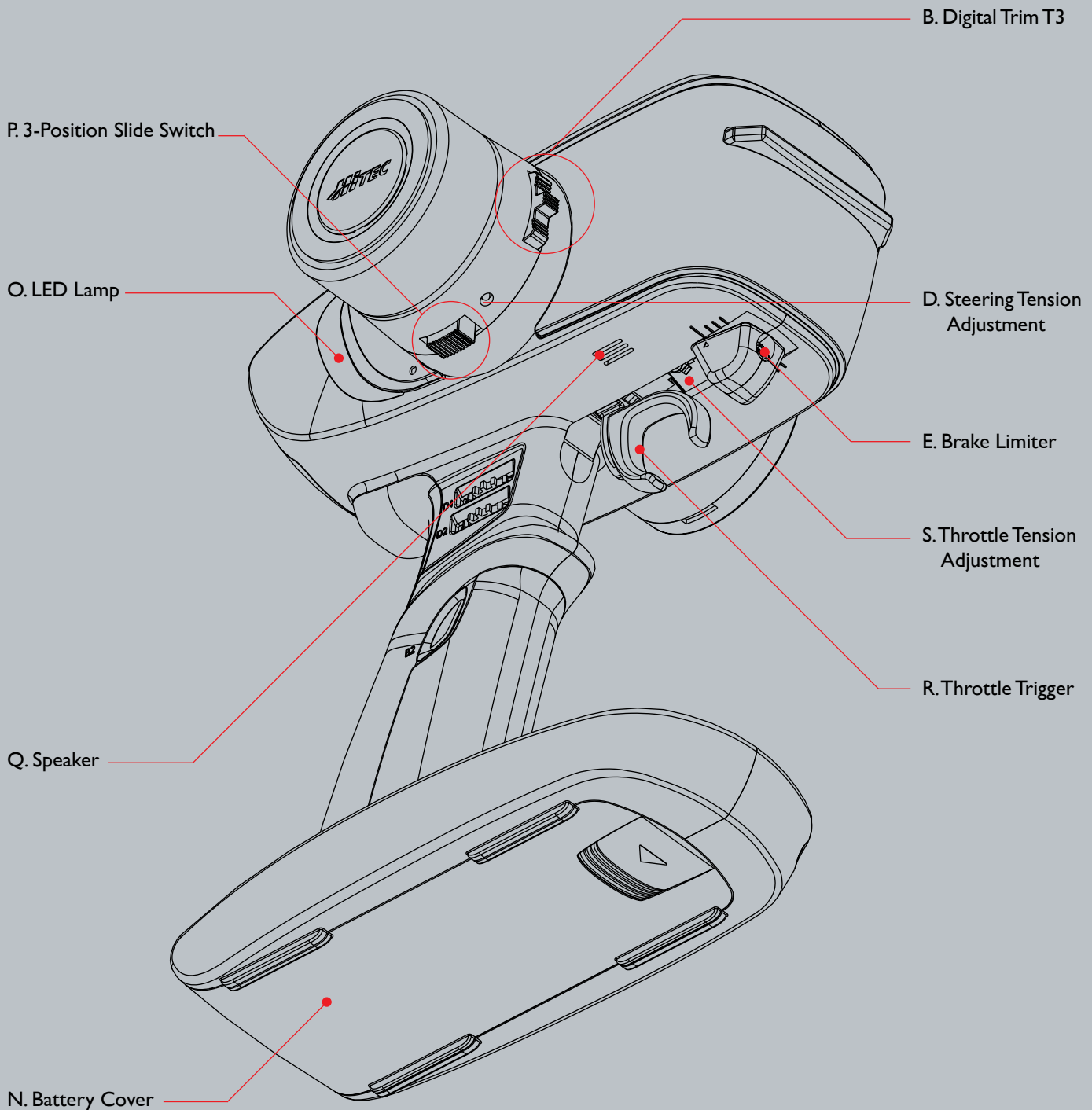

Note

Should you change the function set-up for the Digital Button, Digital Trim, or Dial, turn off the power switch **ONLY AFTER** waiting several seconds. Powering down too quickly may result in your changes being lost.

LYNX 4S Layout (cont.)

A. Programming Buttons:

Main Dial: Use the main dial to scroll through menu options or to change the value of programmable functions.

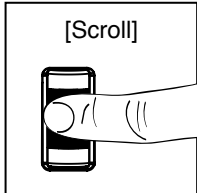

Scroll:

Move through all function and display menus. When a function with user-specified values (TEMP, VOLT, SPEED, etc.) is highlighted, use the scroll feature of the Main Dial to view the range of possible values for that function.

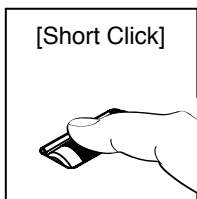

Short Click:

Select the menu or set value.

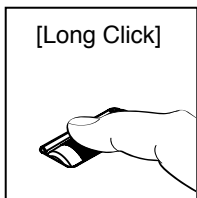

Long Click:

Revert to the original default set value by holding down the Main Dial for a one second count.



Note

Adjust the servo horn or use the S-TRIM set-up feature if your R/C model fails to drive in a straight line even after programming the trim to its max setting.

C. Dial D1 / D2:

Through the fast dial control of the Lynx 4S, you can adjust set-up values quickly for 22 different functions. For more details, please refer to Page 38.

D. Steering Tension Adjustment:

For the convenience of the user, you can adjust the steering tension on your Lynx 4S steering wheel to your preference with the use of a 1.5mm hex wrench. To stiffen the resistance of the steering wheel, turn the wrench clockwise. To make the tension of the steering wheel smoother, turn the wrench counterclockwise.

E. Brake Limiter:

For the convenience of the user, you can adjust the brake's maximum travel range to your preference with the use of a 2.5mm hex wrench. To shorten the brake's travel range, turn your wrench clockwise. To lengthen the brake's travel range, turn your wrench counterclockwise.



Note

Please review and adjust as necessary the set-up values for neutral servo position, throttle, EPA, EXP and so on whenever you alter the brake's travel range.

F. Steering Wheel:

Control the direction of the model.

LYNX 4S Layout

G. Digital Button B2:

Through the push/lock-style Digital Button, you can initiate or close 18 different Lynx 4S menu screens. For more details, please refer to Page 35.

H. Grip Handle:

The ergonomic design of the Lynx 4S grip handle allows you to comfortably and confidently maintain stable control of your R/C model.

I. Charging Port:

Requires the use of Hitec's Lynx 4S overnight charger via the radio's own built-in charging port. Please note that other non-Hitec chargers are neither tested nor approved for compatibility with your Lynx 4S.



Note

Depending on the country of purchase, some versions of the Lynx 4S radio system do not include overnight chargers.

J. Protection Cover (earphone port, PC port):

Connecting your earphones or headphones to the Lynx 4S enhances the user experience by adding an audio component with telemetry voice data or music. By connecting the Lynx 4S to your PC with an HPP-22 add-on option, you can update the firmware of your Lynx 4S as it becomes available.



Note

Depending on the country of purchase, some versions of the Lynx 4S radio system do not include overnight chargers.

K. Power Switch / Display:

With a 3-position switch, the user navigates through PWR ON, OFF, and DISP ON positions as desired. To turn on the transmitter and RF module together, move the power switch to the right. Moving the power switch to the left position activates the display menu only, without the RF module.



Note

Please power "ON" your transmitter before your receiver and power "OFF" your receiver before the transmitter to avoid accident or unintended consequences.

L. Push/Lock Button B1:

Through the push/lock-style Digital Button, you can initiate or pause 9 different menus on your Lynx 4S. For more details, please refer to Page 35.

M. Dial & Push Button D3:

With a combined dial /push button, you can control each dial and push input separately. The D3 dial button allows for the adjustment of 22 different Lynx 4S set-up values. The D3 push button controls the set-up values for 18 different Lynx 4S functions. For more details, please refer to Page 35.

N. Battery Cover:

The battery cover offers outer protection from shock vibrations and dust particles. Please ensure that the cover is on securely any time you replace the battery.

LYNX 4S Layout cont.

O. LED Lamp:

The LED Lamp has a lighting scheme of six different colors that indicate a corresponding status of your Lynx 4S.

P. 3-Position Slide Switch SW1:

With a 3-Position switch, you can adjust the set-up value for 4 different Lynx 4S functions.

This switch is especially useful for Crawler models or those models with individual wheel control.

Q. Speaker:

The built-in speaker emits telemetry voice data and music audio.

R. Throttle Trigger:

The throttle trigger determines forward and reverse acceleration as well as brake control.

S. Throttle Tension Adjustment:

Users are able to adjust throttle tension with a 1.5 mm hex wrench. To create stiffer tension in the throttle, insert and turn the wrench clockwise. To create a smoother throttle tension, turn the wrench counterclockwise.

Battery Port and Micro SD Card Port:

Li-Fe, Li-Po, Ni-MH and Ni-CD batteries are supported with your Lynx 4S battery port. By inserting a micro SD card, you can play music and telemetry voice data or expand the memory capacity for up to 30 models.

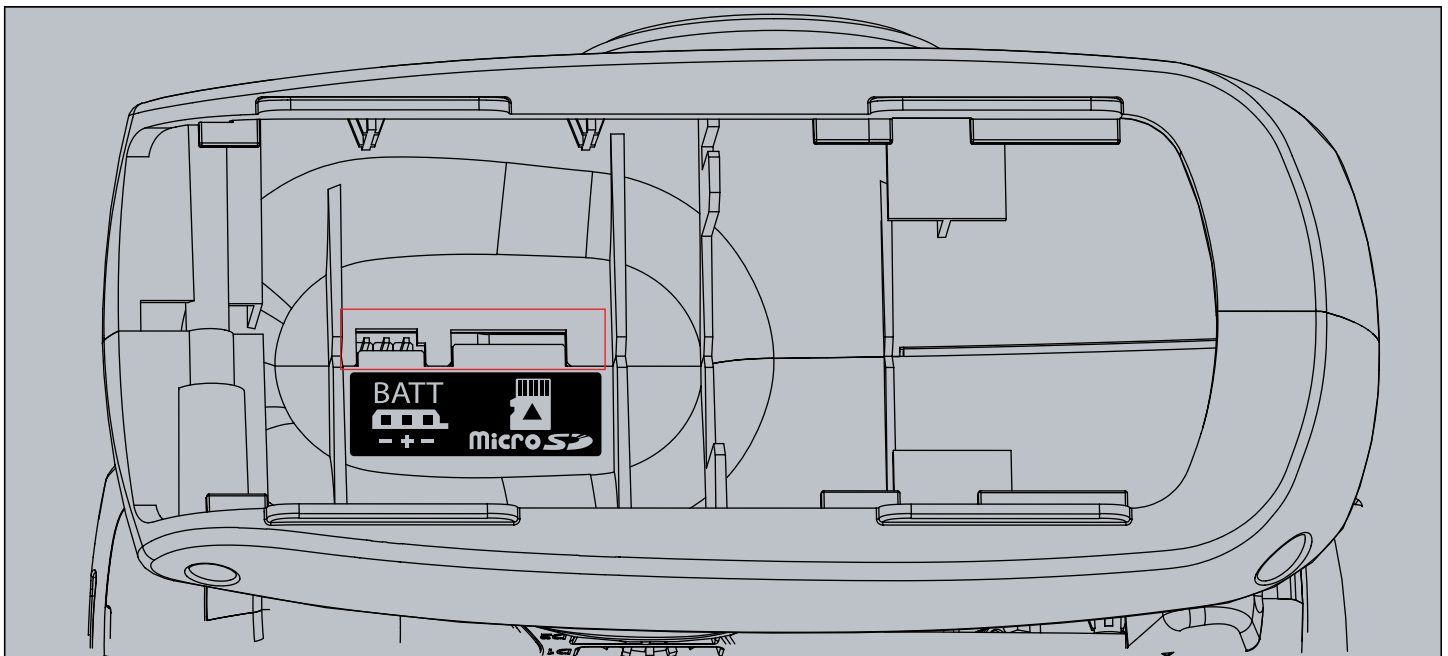

Note

This battery port is designed to work with batteries of opposing polarity.

Changing the Position of the Steering Wheel

Installing the Extension Adapter (included) gives you the option of changing the location of the steering wheel. The adapter improves comfort control for the Lynx 4S by allowing the steering wheel unit and throttle trigger to be positioned at the same level.

Disassembling the Steering Wheel Unit:



Note

You will need a Phillips screwdriver to complete the following procedure. Do not force the bolts together or apart if you encounter resistance as you can damage the unit. Work with the bolts until they slide easily into position.

1. Lift the groove under the steering wheel cover to remove it.
2. Loosen the 2.6 x 12mm screw bolt affixed to the steering wheel.
3. Pull the steering wheel adapter apart by hand to separate.
4. Loosen each of the three 28mm screw bolts from the wheel unit.
5. Disconnect the cable attached to the Steering Gimbal unit.

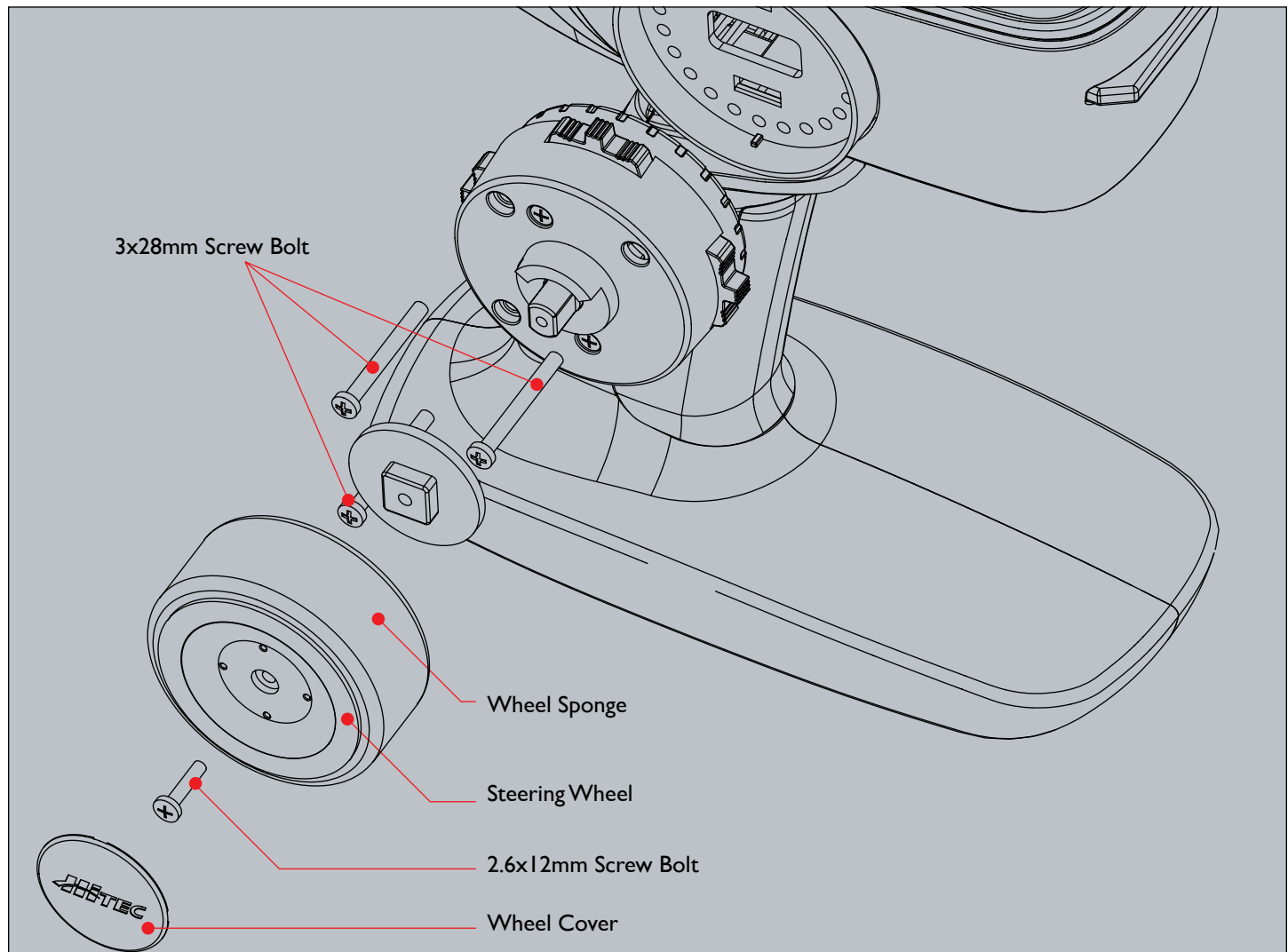

Changing the Position of the Steering Wheel (cont.)



Note

The following procedure requires a Phillips screwdriver and 2.4mm hex wrench.

1. Connect the TX wire to the Steering Gimbal unit by passing the wire through the hole of the extension adapter.
2. Affix the extension adapter to the Lynx 4S by inserting 3 20mm hex bolts into the face of the adapter using your 2.5mm hex wrench.
3. Attach the wheel unit using the 3 28mm screw bolts.
4. Attach the steering wheel using the 2.6X12mm screw bolt.
5. Snap the steering wheel cover back in place.

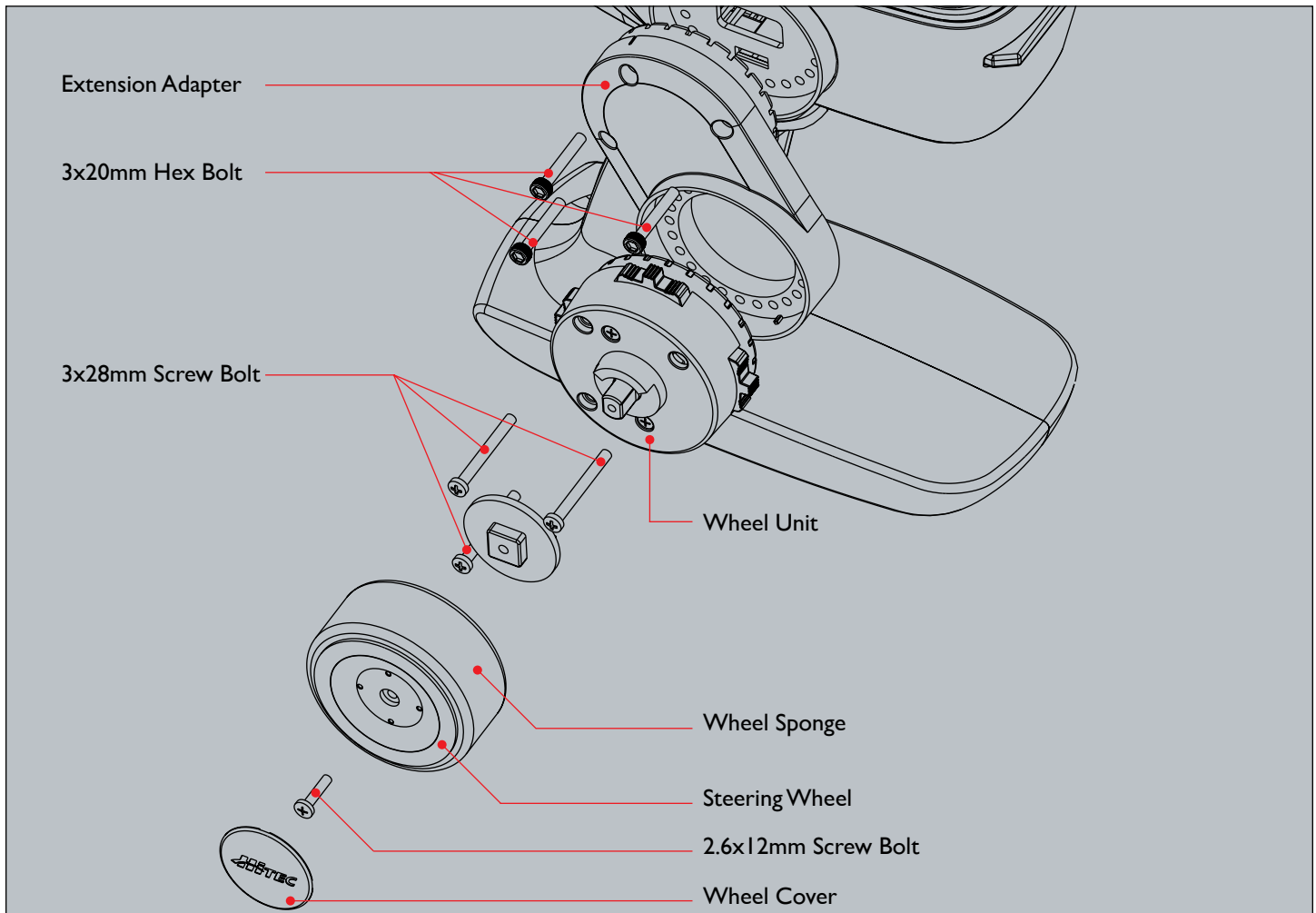

Note

Be mindful when handling the sharp ends of the wire.

Modifying for Left-Hand Users



Note

The following procedure requires a Phillips screwdriver.

1. Disassemble the steering wheel unit. Refer to Page 11 for a detailed explanation.
2. Lift up on the groove under the steering wheel cover located on the back of the radio to separate. Both front and back covers should now be removed.
3. Push the wire system exposed in the front of the Lynx 4S back through the rear opening you just uncovered.
4. Put the TX back together in reverse order of disassembly after connecting the wire to the wheel unit.
5. Reattach the battery cover on the opposite side.

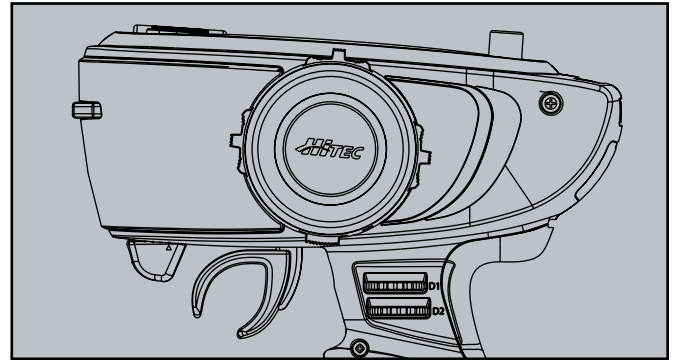
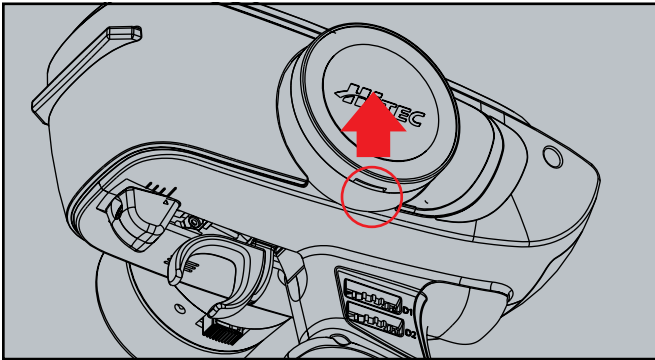

Note

Be mindful when handling the sharp ends of the wire.

Rubber Grip and Neck Strap

As the owner of a Lynx 4S, you have the ability to replace the factory grip rubber with one more suitable to your grip size. You may also choose to install a neck strap holder if you've found your R/C experience necessitates it.

1. Pull down and out on the grip rubber in the direction pictured below.
2. Separate the grip rubber completely.
3. Attach the holder mount with two screws to the underside of the grip rubber as indicated.
4. Push the grip rubber back into place.
5. If you are replacing the grip rubber with a thicker version, simply remove the original as described in steps 1 and 2.

LYNX 4S MANUAL: SECTION I

Rubber Grip and Neck Strap (cont.)

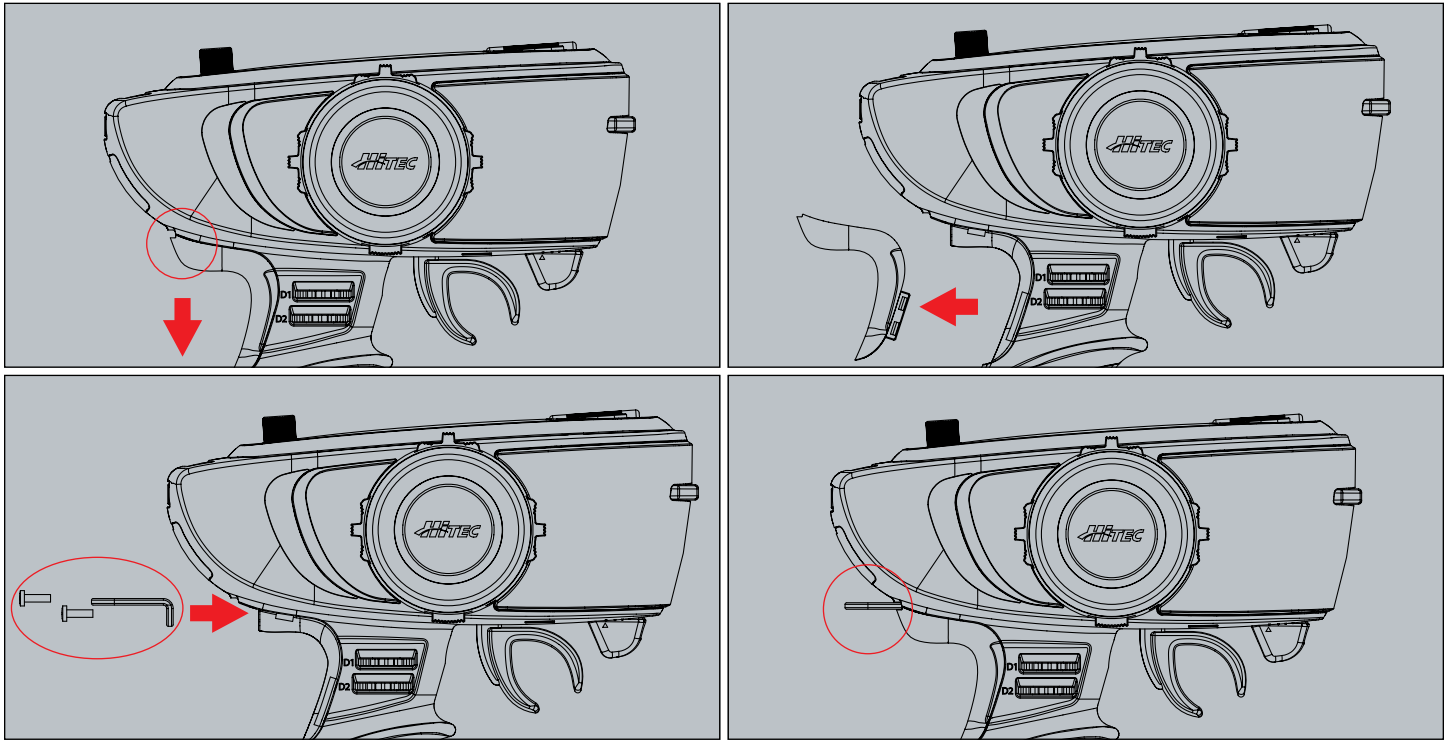

Receiver

Hitec's unique AFHSS (Adaptive Frequency Hopping Spread Spectrum) 2.4GHz system achieves new levels of outstanding performance and stability.

Receiver Model	Model Size	Weight	Stock Number
AXION 2	1.26 x 0.87 x 0.43in (32 x 22.3 x 11mm)	0.25oz (7.0g)	27724
AXION 4	1.26 x 0.87 x 0.43in (32 x 22.3 x 11mm)	0.25oz (7.0g)	27824



Warning

1. The receiver antenna should never be placed near the engine, metal parts, or high current batteries.
2. To prevent damage to the antenna, do not bend them beyond a 90 degree angle.
3. Adhere Velcro or double-sided tape directly to the bottom of the receiver to absorb shock during use.
4. When the LED indicator blinks irregularly, an unstable frequency environment is indicated. Cease use and assess your surroundings for the possible cause.

AXION 2 & AXION 4:

1. Function Button

Used for linking the receiver to a transmitter.

2. LED Status Indicator

Indicates the set-up process codes and current status of AXION receivers.

3. Channel Output and Battery Input Ports

These ports are for batteries, servos, and other accessories.

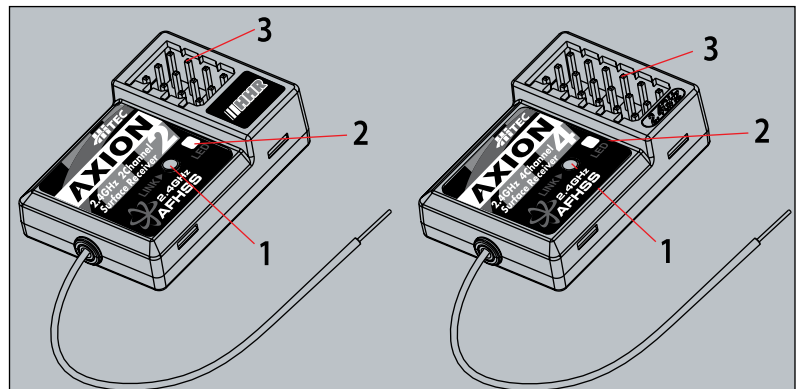

Receiver (cont.)

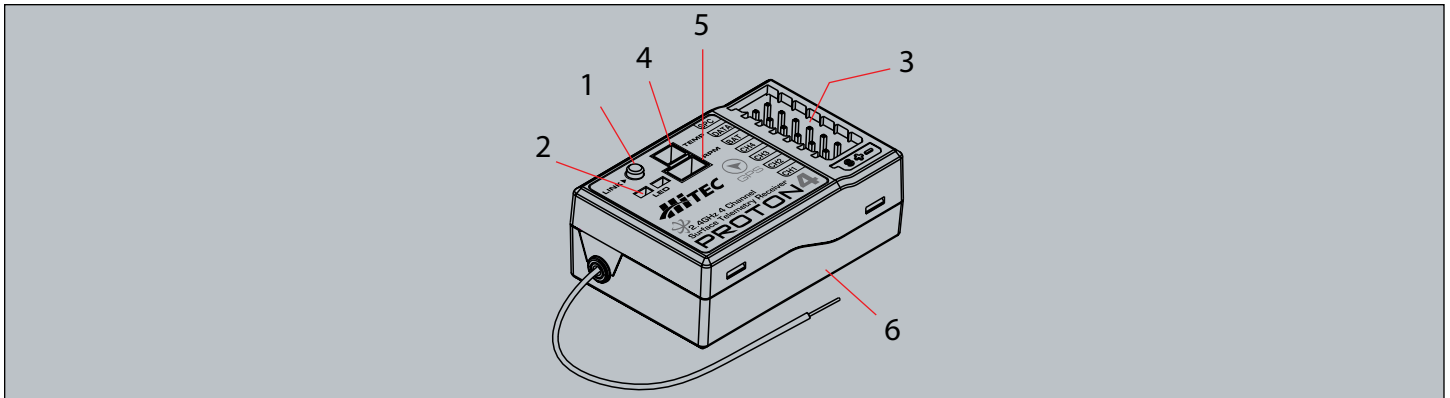

Proton 4:

1. Function Button:

Used for linking the receiver to a transmitter.

2. LED Status Indicator:

Indicates the set-up process codes and the current status of a Proton 4 receiver.

3. Channel Output and Battery Input Ports:

These ports are for batteries, servos and other accessories.

4. Temp Port:

The temperature of your model can be checked via a temperature sensor. A temperature alarm can also be set.

5. RPM Port:

Checks RPM and speed with an RPM sensor.

6. GPS Sensor (installed):

A GPS sensor is factory-installed in the Proton 4 to gauge your car speed.

Operating Voltage:

Accepts four to six cell rechargeable NiMH, NiCD, or LiPo batteries (4.8~7.4V).

Selecting the appropriate voltage depends on the capabilities of the servos you intend to use.

HTS-TEMP (Temperature Sensor):

A temp sensor can be used by plugging it into the PROTON 4 receiver without a sensor station. Attach the sensor to a target surface such as a motor, an ESC, or an engine. Gauge Range: 0~250 degrees C, 32~482 degrees F.

HTS-MRPM (RPM Sensor):

An RPM sensor can be used by plugging it into the Proton 4 receiver without a sensor station. Attach the sensor to a target surface like a spur gear or fly wheel. Gauge Range: 0~99999 RPM.

GPS Sensor (Built-in RX Type):

A GPS speed sensor is factory-installed in the Proton 4 receiver. You can gauge your car speed on the Lynx 4S screen by using the Proton 4 receiver without any attachments. Range : 0~250km/H. Remember to use your GPS sensor outdoors only as it will not receive satellite information inside.

Receiver Installation

Receivers depend on sensitive technology. Do not expose your receiver to jarring vibrations, shock, or dust. Remember to take appropriate measures, like using sponge pads or thick, double-sided tape, to insulate your receiver against damaging forces. Do not bend or cut the ends of the 2.4GHz RX's antenna wire. Please refer to the picture below for the proper installation method.

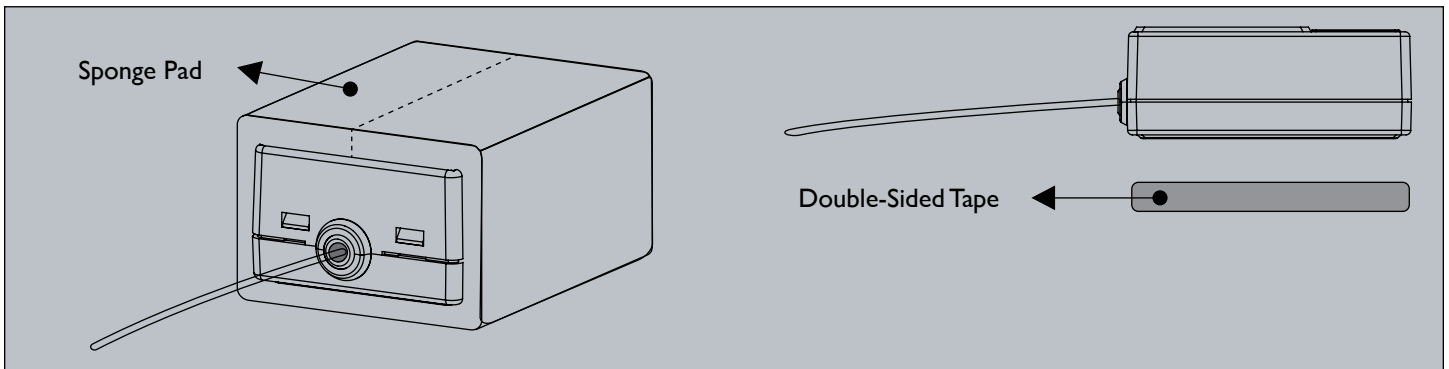

WARNING

You can protect the receiver's antenna by encasing them in rubber tubing.

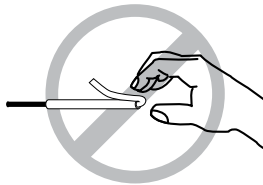
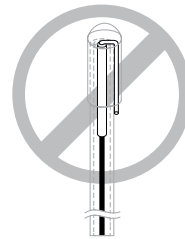
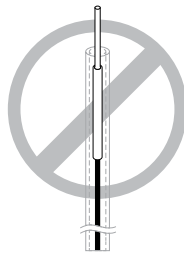
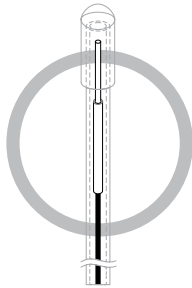

Do not bend the antenna.

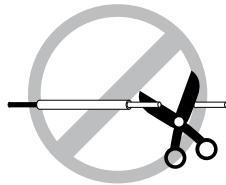

Do not cut the antenna.

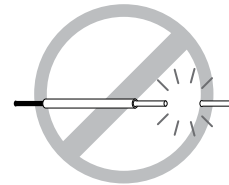

Do not use broken antenna.



Note

Please install receivers away from batteries, motors, ESCs or engines that generate noise. The receiver's antenna are especially susceptible to audio interference.

Receiver Connection Diagrams

In the case of an R/C car model, install servos as depicted below. The diagram shown here illustrates proper installation of 2 servos in a 2-channel car model system which can be changed by installing an ESC or engine.

Receiver Connection Diagrams (AXION 2):

Shown: Electric-powered car with an Electric Speed Controller. Use this method on electrically-powered motor vehicles, as the ESC will provide power to the receiver and servo systems.

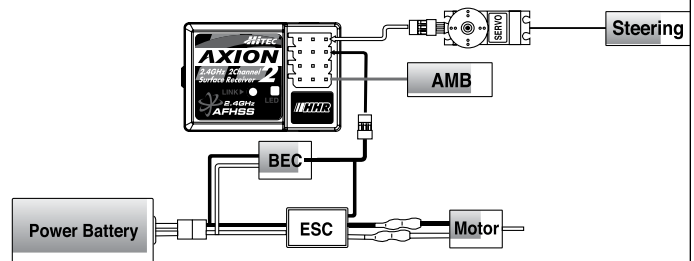

Receiver Connection Diagrams (AXION 4):

Shown: In the case of glow, gas, or electric-powered cars using a separate receiver battery supply, follow the connection set-up pictured here.

Note: Requires 2-cell LiPo/LiFe batteries or 4.8~7.2V 4-6-cell NiMH/NiCD batteries.

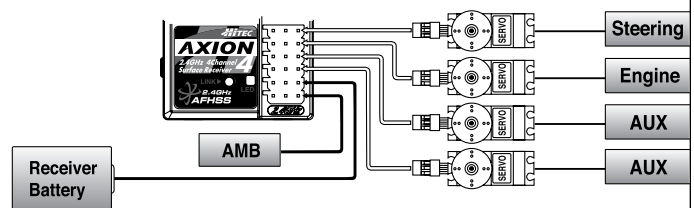

Receiver Connection Diagrams (PROTON 4):

Shown: In the case of glow, gas, or electric-powered cars using a separate receiver battery supply, follow the connection set-up pictured here.

Note: Requires 2-cell LiPo/LiFe batteries or 4.8~7.2V 4-6-cell NiMH/NiCD batteries.

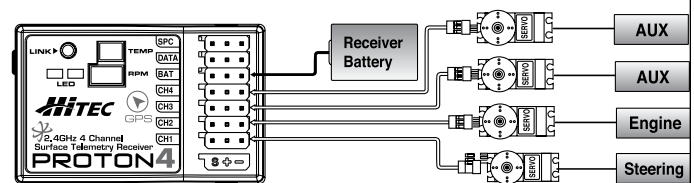

ESC, servos, engines and other items are sold separately. Refer to the MIX menu when using all 4 channels with the mixing function.

Charging

Charging Your Battery:

The Lynx 4S radio set includes a NiMH 4-cell battery for your convenience. We recommend using Hitec's overnight charger (CG-S82 220V/ CG-S85 110V) for your battery charging needs.



Depending on the country of purchase, the CG-S82 (220V) / CG-S85 (110V) overnight chargers may not be included with your Lynx 4S package. Do not use CG-S83/S85 Hitec overnight chargers with LiPo/LiFe batteries.

Charging (cont.)



Note

Although an overnight charger is preferred, you have other options when charging your batteries. If you do not currently own an overnight charger, remove the battery from your radio and charge the TX battery with a charger approved for your battery type.



Note

When charging with a charger of your own, set the charging amperage to 1A.

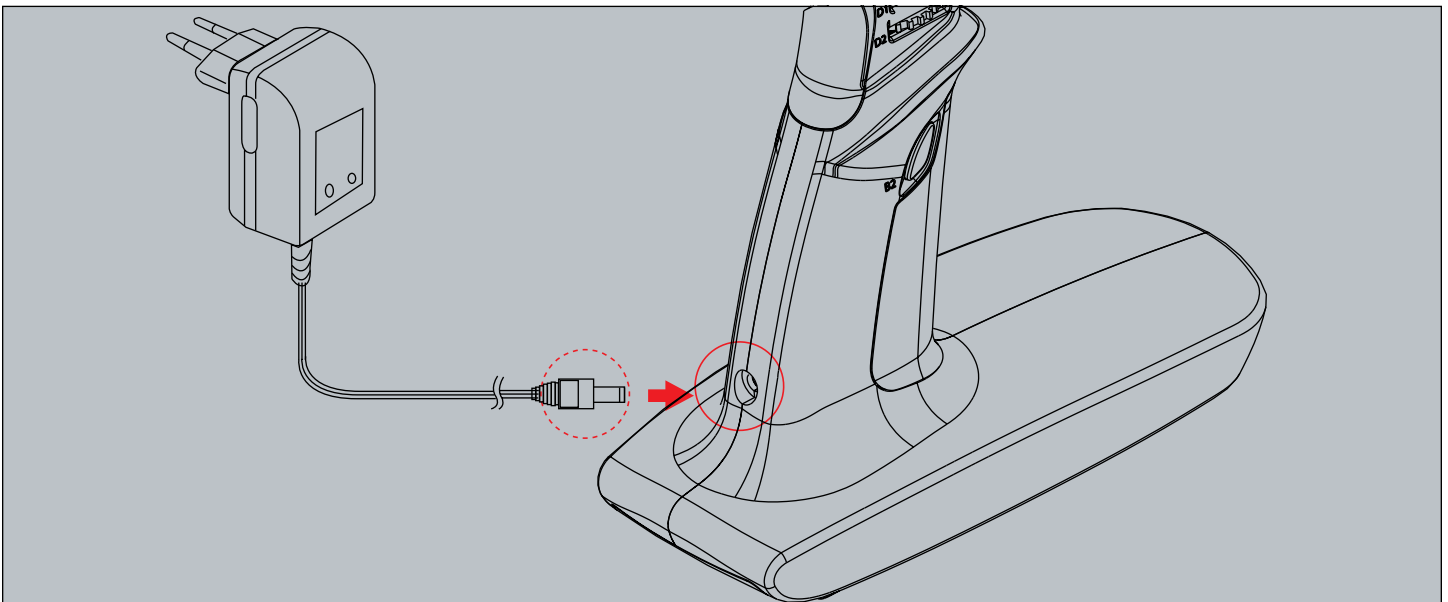

Charging with CG-S82 (220V)/ CG-S85 (110V):

1. Connect the plug for the overnight charger to the charging port on your Lynx 4S.
2. A red light will glow to indicate active charging.
3. A green light will glow when the device is fully charged.



Note

If your Lynx 4S is turned on at the time you connect your overnight charger to the charging port, power to the radio will cut automatically.

Main Display

The main display shows general information regarding the operation of the Lynx 4S with your R/C models. The display is customizable by the user.

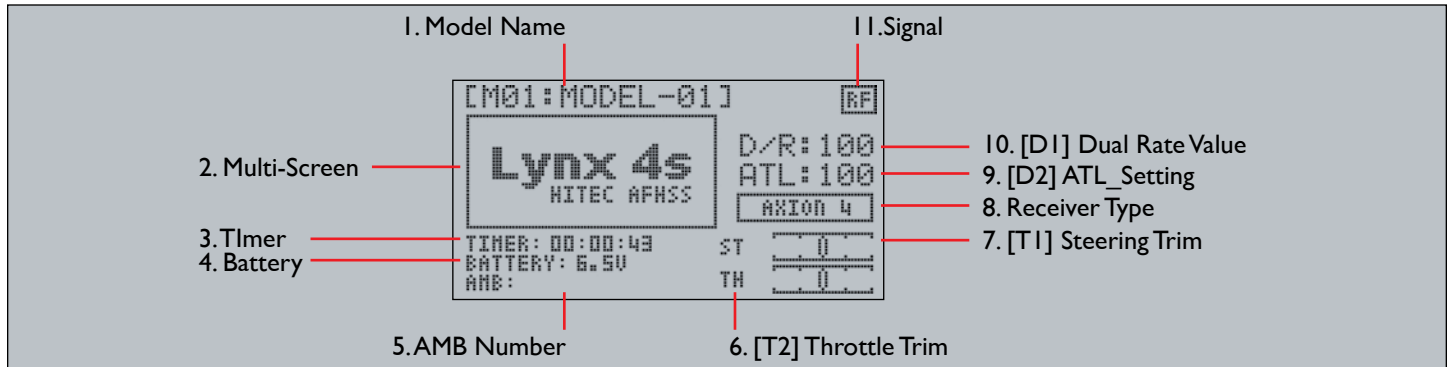

1. Model Name:

Indicates the current operating model name and number.

2. Multi-Screen:

Option to change the display to show logo, name of user, timer, etc.

3. Timer:

Total length of usage time after the power has been turned on.

4. Battery:

Displays the voltage of the radio's battery.

5. AMB Number:

Personal transponder number, which identifies your model when racing against other models and allows you to read your car's timing and scoring output.

6. [T2] Throttle Trim:

Shows current throttle trim value. Default position is linked with the T2 switch.

7. [T1] Steering Trim:

Shows the current steering trim value. Default position is linked with the T1 switch.

8. Receiver Type:

Shows receiver detail information as well as the status of the BOOST function.

9. [D2] ATL_Setting:

Shows current ATL settings. Default position is linked with the D2 dial.

10. [D1] Dual Rate Value:

Shows the current dual rate value. Default position is linked with the D1 dial.

11. Signal:

Shows the radio's signal or frequency.



Note

Information on the main display may be saved to memory.

Sub Menus

MODEL PROGRAMING SET 1 [Pages 22 – 27]

From this screen you can program the following items:

Servo Reverse (R.E.V.), Endpoint Adjustments (E.P.A.), Brake Rate (ATL), Anti-Lock Brake (ABS), Steering Exponential (ST-EXP), Brake Exponential (BK-EXP), Throttle Exponential (TH-EXP), Steering Dual Rate (ST-D/R), Sub Trims (S-TRIM) and FAILSAFE.

SET 1/2	SYS	MODEL	SD
R.E.V		BK-EXP	
E.P.A		TH-EXP	
A.T.L		ST-D/R	
A.B.S		S-TRIM	
ST-EXP		FAILSAFE	

MODEL PROGRAMING SET 2 [Pages 28 – 39]

From this screen you can program the following items:

Auto Boost (BOOST), Steering Servo Speed (ST-SPD), Throttle Servo Speed (TH-SPD), Throttle Mode (TH-MOD), Idle Up/Down (IDL-UP), Race, Lap and Countdown Timer (TIMER), LAP LISTS, Switch Settings (SWITCH) Radio Dial Settings (DIAL) and Channel Mixing (MIX).

SET 2/2	SYS	MODEL	SD
BOOST		TIMER	
ST-SPD		LAP LIST	
TH-SPD		SWITCH	
TH-MOD		DIAL	
IDL-UP		MIX	

SYSTEM PROGRAMMING [Pages 40 – 50]

From this screen you can program these system settings:

Steering Adjustment (ST-ADJ), Throttle Adjustment (TH-ADJ), Receiver Binding (RX-BIND), Radio Frequency Scanning (RF-SCAN), SERVO Monitor, Telemetry Sensors setup (SENSOR), System MANAGEMENT, TELEMETRY Display, VIBRATION Setting and BATTERY Type Settings.

SET	SYSTEM	MODEL	SD
ST-ADJ		SENSOR	
TH-ADJ		MANAGEMENT	
RX-BIND		TELEMETRY	
RF-SCAN		VIBRATION	
SERVO		BATTERY	

MODEL MANAGEMENT [Pages 51 – 52]

From the model management screen do the following:

NAME your model, DELETE a model from the memory, COPY a model to an empty memory slot, and CHANGE the active model.

SET	SYS	MODEL	SD
NAME			
DELETE			
COPY			
CHANGE			

SD CARD MANAGEMENT [Pages 53 – 55]

In this section you can perform the following tasks:

NAME the SD card, DELETE model data from the SD card, IMPORT and EXPORT models from the SD card, setup and adjust the VOICE functions and play MUSIC from the SD card.

SET	SYS	MODEL	SDCARD
SD-NAME			MUSIC
SD-DELETE			
SD-IMPORT			
SD-EXPORT			
VOICE			

REV (Servo Reverse)

The REV function enables the user to adjust servo direction with changes to steering, throttle, and maneuvering the 3CH and 4CH models (settings are either clockwise or counterclockwise).

1. From the main screen, press the Main Dial button to enter the function menu.
2. With the "SET 1/2" tab highlighted, press the Main Dial button to access the function options below. Select REV by pressing the Main Dial again.
3. Scroll through the options using the Main Dial scroll feature and click the Main Dial once to select your channel.



Note

If you have fine-tuned the direction of your servo with sub-trim adjustments, the sub-trim settings will take affect on the opposite side when you apply the servo-reverse function.

EPA (End Point Adjust)

This function allows the user to set the maximum operating angle of the servo that is linked to the transmitter. This option comes in handy if the turning radius of the car varies from left to right due to the condition of the vehicle. (Note: the setting ranges from a Min. 0~ Max. 120 for each channel.)

1. Press the Main Dial button from the home screen to access the function menu.
2. Select EPA from the SET 1/2 tab by clicking on SET 1/2 first and then EPA when highlighted.
3. Use the Main Dial to scroll through your options and click the Main Dial to select the appropriate channel.
4. After selecting your channel, maneuver the trigger to control steering and throttle.

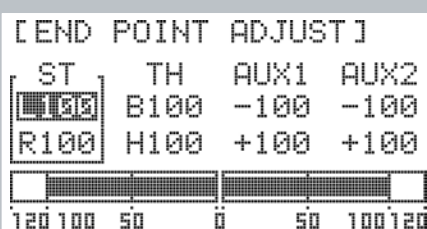

Note

The EPA function is pre-set to the maximum working angle of the servo. If that setting has been altered, it may affect EPA functionality. If you wish to set the maximum angle of the servo with EPA settings, it is recommended that you return the EPA to its default setting. See below.

[ATL] = Page 22: default= 100

[ST-D/R] = Page 26: default= 100

[S-TRIM] = (Page XX): default position for each channel= 0.

ATL (Brake Rate)

The ATL (Adjustable Travel Limiter) affects the braking response of your vehicle. A higher ATL value corresponds to a firmer braking response (a 100% value is the equivalent of slamming on your brakes), while a lower setting results in a more gradual stop.

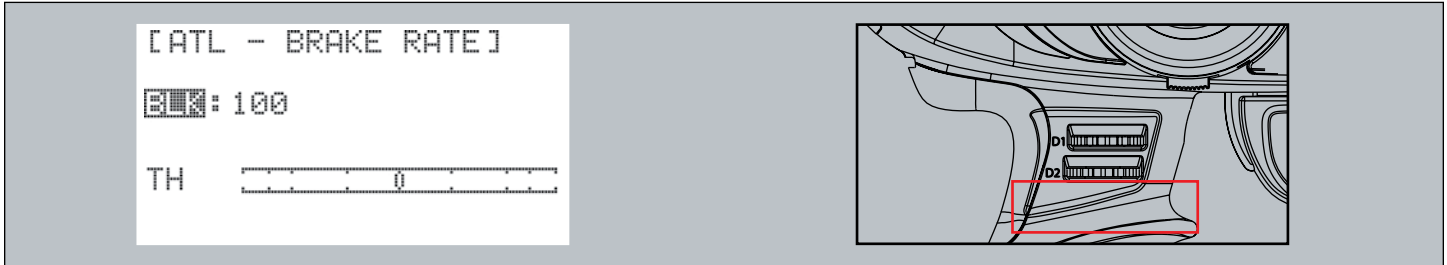

1. The ATL value setting can be adjusted with the D2 Dial [under MIX mode I] shortcut.
2. Alternatively, you can access the ATL function by pressing the Main Dial from the home screen to view the function menu.
3. Next, select ATL from the SET 1/2 tab by clicking on the tab and then using the Main Dial button to scroll and highlight "ATL."
4. Press the Main Dial button to select. Adjust to the appropriate value.
5. You can check the current ATL value setting on the home screen which is viewable on the right-hand side.



Note

A.T.L. is a supporting function of the Brake EPA settings.

ABS (Anti-Lock Brake)

ABS improves braking sensitivity, cornering, and stability under adverse road conditions.

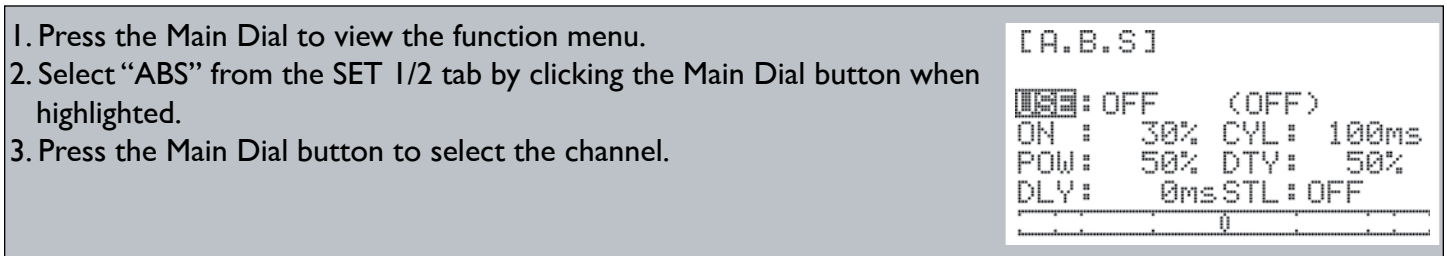

1. Press the Main Dial to view the function menu.
2. Select "ABS" from the SET 1/2 tab by clicking the Main Dial button when highlighted.
3. Press the Main Dial button to select the channel.



Note

The user must set a lower CYL value when using low speed servos. Be aware that excessive use of ABS may cause damage to your servos.

ABS (Anti-Lock Brake cont.)

Terms for ABS Setting:

USE: Indicates the status (ON/OFF) of ABS [default: OFF]

ON: The starting point of ABS operation when maneuvering the brake trigger [default: 30%]

POW: The angle of the ABS brake power [default: 50%]

DLY: Delays the time of ABS operation after setting the ABS starting point [default: 0ms]

CYL: The recurring engagement time of the ABS brake [default: 100ms]

STL: Steering mixing [default position: OFF]

You may change the ON/OFF steering setting while brakes are activated.

See below for the ABS operating range when steering under an N50% and E50% setting:

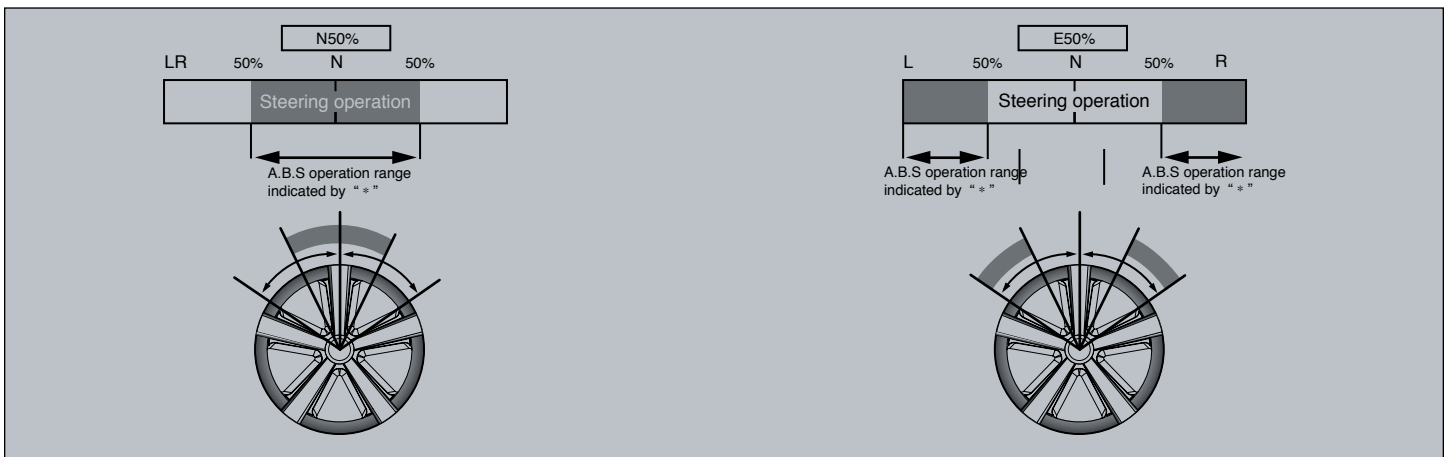

ST-EXP (Steering Exponential)

Enables the user to set their preferred servo operating conditions for steering, with steering response ranging from more to less sensitive.

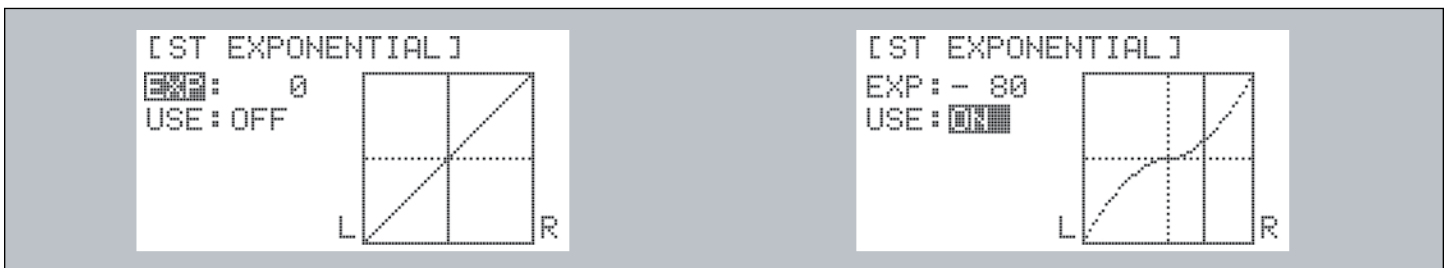

1. Press the Main Dial to enter the function menu.
2. Select ST-EXP from the SET 1/2 tab using your Main Dial button's scroll and click functions.
3. Press the Main Dial button to select the appropriate option.



Note

ST-EXP may be adjusted with an external switch. Please refer to Page 37 for details.

BK-EXP (Brake Exponential)

Sets the servo operating conditions for brake direction. By adjusting these settings, you can create a more or less sensitive braking response for your vehicle.

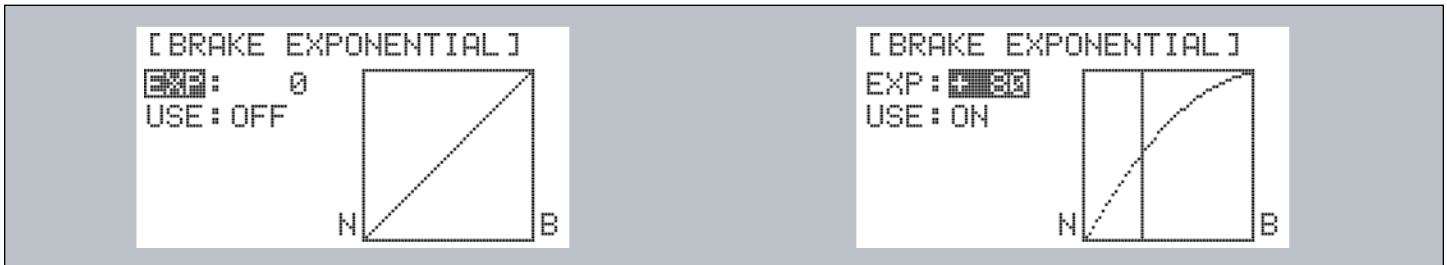

1. Press the Main Dial button to view the function menu.
2. Select BK-EXP from the SET 1/2 tab with the Main Dial button's scroll and click functions.
3. Press the Main Dial button to select the appropriate option.



Note

BK-EXP may be adjusted with an external switch. Please refer to Page 37 for details.

TH-EXP (Throttle Exponential)

Enables the user to set their preferred servo operating conditions for throttle, with throttle adjustments that can create either a rougher or smoother acceleration experience.

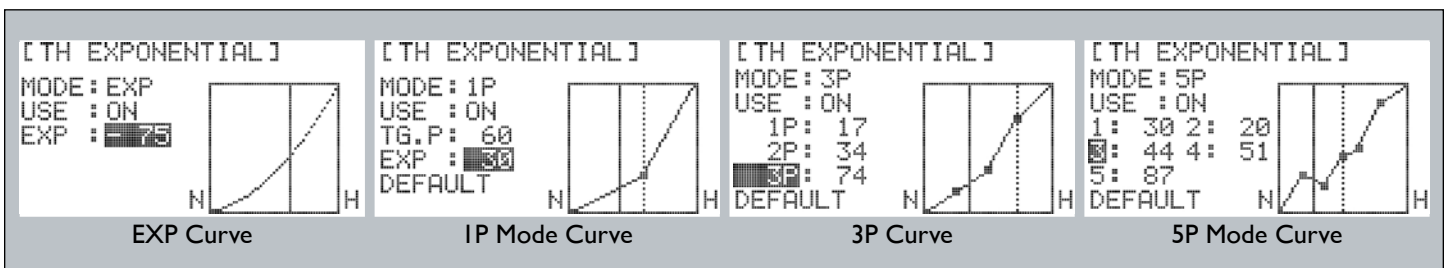

1. Users have 4 Curve options when setting up TH-EXP.
2. Press the Main Dial to access the function menu.
3. Select TH-EXP from the SET 1/2 tab with the Main Dial button's scroll and click functions.
4. Click the Main Dial when you have selected the desired option.



Note

TH-EXP may be adjusted with an external switch. Please refer to Page 37 for details.

ST-D/R (Steering Dual Rate)

Users have the option of increasing or decreasing the servo operation angle with the dual rate adjusting dial [Default: 100].

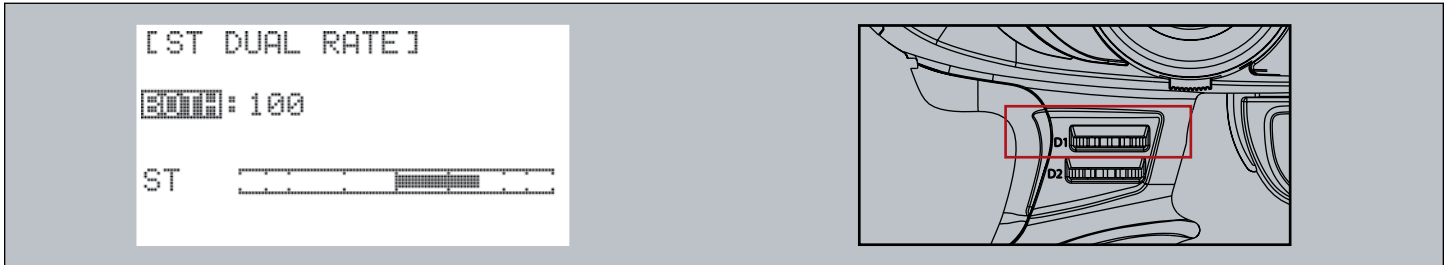

1. ST-D/R function is adjusted by the D1 Dial [under MIX mode I].
2. Press the Main Dial button from the home screen to access the function menu.
3. Select ST-D/R under the SET 1/2 tab with the scroll/click function of the Main Dial button.
4. When the desired option is highlighted, click the Main Dial button to select.
5. The current value of the ST-D/R function is viewable on the right of the home screen in graph form.



Dual Rate is linked to the EPA function, so check the operating angle of the servo before engaging your vehicle. ST-D/R may be adjusted by external switch. Please refer to Page 38 for details.

S-TRIM (Sub Trim)

If the vehicle drives off-center or when the position of the servo affects proper functioning of the servo horn, change the position of the servo [Default: 0].

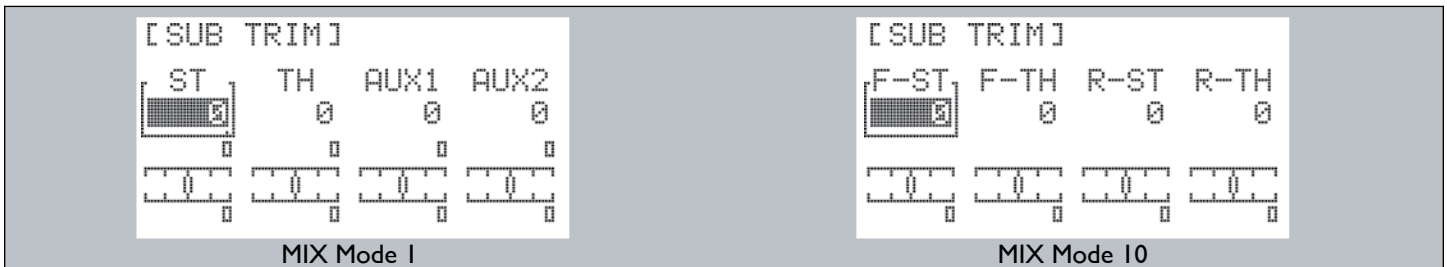

1. MIX function settings may cause changes to the channel names.
2. Press the Main Dial button to access the function menu.
3. Select S-Trim from the SET 1/2 tab by using the Main Dial's scroll and click functions.
4. Click the Mai Dial button when the desired option is highlighted to select.
5. The current sub-trim value is viewable in graph form on the home screen.



Set the S-Trim to '0' and review the location of the horn for proper alignment before installing the servo(s) in your vehicle. Use the S-TRIM function to adjust and confirm the appropriate center position. If there is a change to the S-Trim set position while driving, use the Sub-trim to re-adjust.

FAIL-SAFE

Engaging the Fail-Safe option will move servos to a pre-saved position should you experience signal interference. As a safety precaution, it is highly recommended that the Fail-Safe mode is activated at all times.

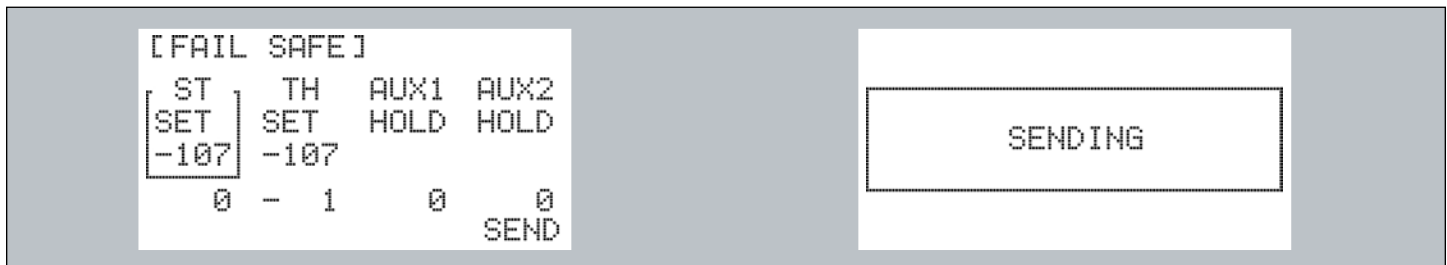

Hold Mode (HOLD):

Servo will maintain its current position when the receiver is not capable of receiving signals.

Set up Mode (SET):

Servo moves to a pre-set position when the receiver is not capable of receiving signals.

1. Press the Main Dial button to access the function menu.
2. Select FAIL-SAFE under the SET 1/2 tab by using the Main Dial button's scroll and click functions.
3. Select HOLD or SET mode as desired after choosing the channel to be changed.
4. Adjust the location of the servo under the 'FAIL-SAFE ON' condition by using the trigger, dial, or switch.
5. To save the current FAIL-SAFE value, press the Main Dial button for a count of a few seconds.
6. After you finish adjusting the settings for each channel, press [SEND] and check the Sending display that will confirm the settings you selected.



Note

The FAIL-SAFE function automatically returns to the default set position when the user changes the type under MIX function. Please re-set the FAIL-SAFE function when this happens. We recommend engaging the brakes to stop engine-powered vehicles and backing off the throttle to stop electric models.

BOOST (Auto Boost)

Quick start is not suitable under slippery road conditions. In conditions prone to tire spin, the BOOST function creates a smoother acceleration.

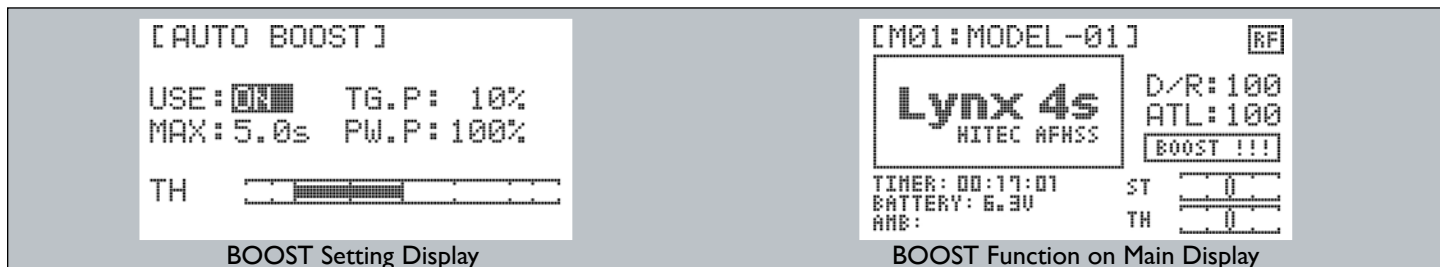

USE: Indicates whether the BOOST function is ON or OFF [default: OFF].

MAX: sets the timer to automatically turn OFF the BOOST function [default: 5s]. (This setting is only maintained when the throttle trigger is at 100%)

TG.P: The point at which the BOOST power starts [default: 10%].

PW.P: The power settings under which the BOOST function is operating [default: 100%].

1. Press the Main Dial button to view the function menu.
2. Select BOOST under the SET 2/2 tab by using the Main Dial's scroll and click functions.
3. Press the Main Dial button to select the channel.
4. The BOOST function automatically shuts OFF after use.
5. You may check the status of the BOOST setting on the graph located on the home screen.

ST-SPD (Steering Servo Speed)

ST-SPD sets the speed for the clockwise/ counterclockwise movement of the servo. It allows for more stable driving conditions for the vehicle on the road.

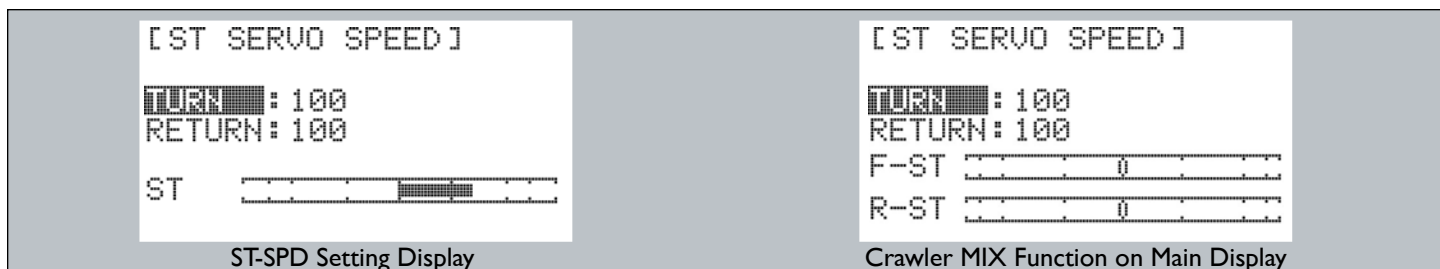

1. Press the Main Dial button to access the function menu.
2. Select SP-SPD under the SET 2/2 tab.
3. Press the Main Dial button to select the channel.
4. Note that lower speed corresponds to a lower set value.
5. The maximum speed cannot be set to exceed the original speed of the servo. Likewise, slower operation does not affect the speed of the servo.



Note

ST-SPD may be adjusted by external switch. Please refer to Page 37 for details.

TH-SPD (Throttle Servo Speed)

TH-SPD enables the user to set the momentum connected to the throttle servo or ESC. It allows for more stable driving control under different road conditions.

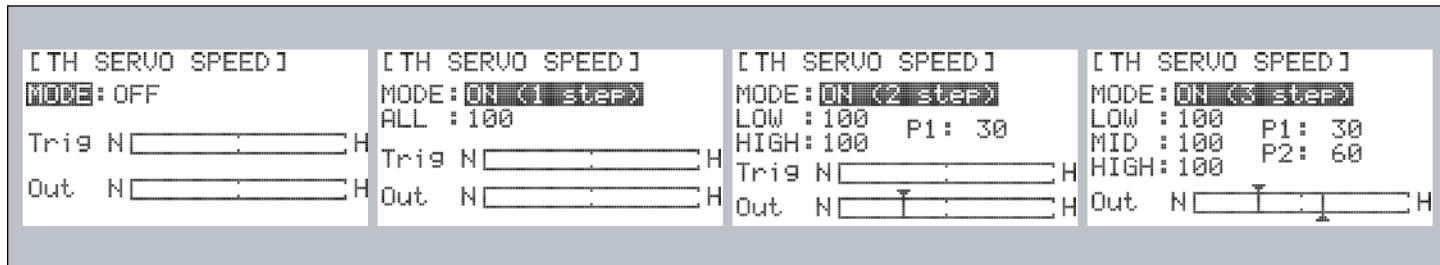

1. TH-SPD has four mode settings.
2. Press the Main Dial button to enter the function menu.
3. Select TH-SPD on the SET 2/2 tab by using the Main Dial button's scroll and click function.
4. Press the Main Dial button to select the channel.
5. Note that a lower speed corresponds to a lower value setting.
6. The maximum speed cannot be set to exceed the original speed of the servo. Likewise, slower operation does not affect the speed of the servo.



Note

TH-SPD may be adjusted by external switch. Please refer to Page 37 for details.

TH-MOD (Throttle Mode)

The R.E.V. function enables the user to adjust servo direction with changes to steering, throttle, and maneuvering the 3CH and 4CH models (settings are either clockwise or counterclockwise).

1. Press the Main Dial button to enter the function menu.
2. Select TH-MOD on the SET 2/2 tab.
3. Select the target setup by clicking the Main Dial button.

The image shows a screenshot of the 'TH MODE' menu. The text 'TH MODE' is at the top, and 'MODE: 50/50' is displayed below it.



Note

Please disconnect the motor from the ESC to disable the Nitro /Gas engine before adjusting TH MODE.

IDL-UP (Idle Up/Down)

The user has the option to adjust the engine's idling parameters. You can prevent idling during vehicle refuel, or you can assign an idling period when you brake.

1. Press the Main Dial button to enter the function menu.
2. Select IDLE UP under the SET 2/2 tab.
3. Select the IDLE UP value suitable for your needs.

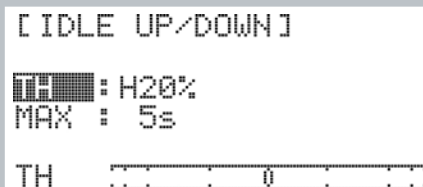

TH: When the TH function is ON, range of activation can be set [Range: B50 / OFF / H50].

MAX: When the MAX function is ON, the IDLE UP time frame can be set. [Range: OFF / 1-60secs]

When the set time has elapsed, the function will shut off automatically.



Note

When IDLE UP is activated, its ON status is visible via a blinking LED light on-screen.

Timer (Race Timer)

Allows the user to monitor relevant clock speeds like total run time, refuel time, and fastest lap time.

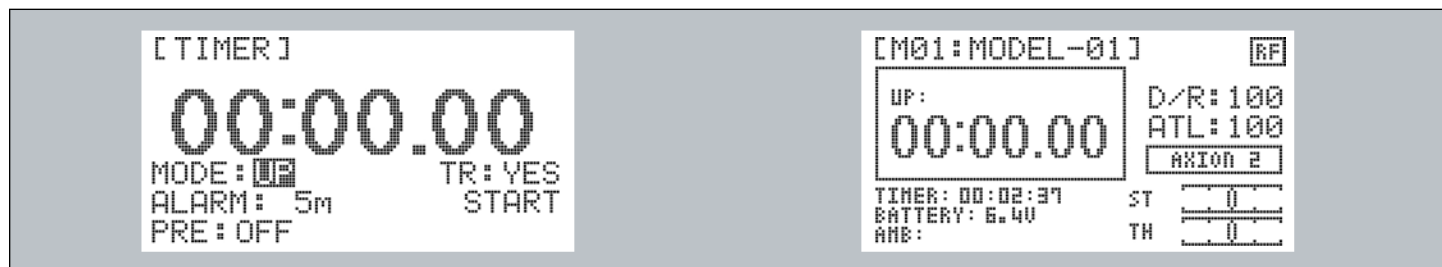

MODE: Select the desired timer function.

ALARM: Set the target alarm time.

PRE: Set a pre-alarm notification. For example, setting a 35 second pre-alarm will sound a warning 35 seconds before your start time.

TR: Activates the timer by moving the throttle trigger.

READY: Clicking Ready will start the timer.

RESET: Resets the timer.

1. Press the Main Dial button to access the function menu.
2. Select 'Timer' under the SET 2/2 tab.
3. Set up the timer function suitable to your needs.
4. Timer will start when you click 'READY' or pull the throttle trigger.

Timer (Race Timer cont.)



Note

Most of the switches can be assigned a TIMER START by switch section. Timers start or stop according to assigned switch. Please refer to Page 37 for more detail.



Note

You can view the current timer function on the main screen. Please refer to Page 52 for more details.

Countdown Timer

The DOWN TIMER option is handy when the user wants to check a certain time, like refuel time, repeatedly.

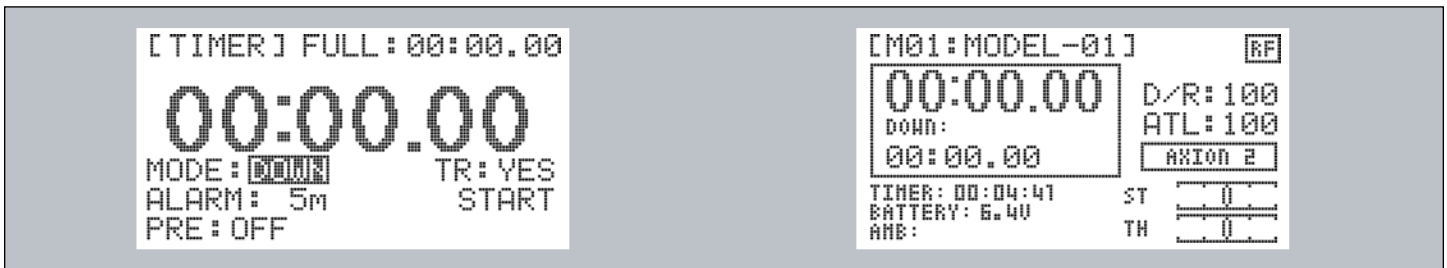

MODE: Select the desired timer function.

ALARM: Set the target alarm time.

PRE: Set a pre-alarm notification. For example, setting a 35 second pre-alarm will sound a warning 35 seconds before your start time.

TR: Activates the timer by moving the throttle trigger.

READY: Clicking Ready will start the timer.

RESET: Resets the timer.

1. Press the Main Dial button to access the function menu.
2. Select 'Timer' under the SET 2/2 tab.
3. Set up the timer function suitable to your needs.
4. Timer will start when you click 'READY' or pull the throttle trigger.



Note

Most of the switches can be assigned a TIMER START. Timers start or stop according to assigned switch. Please refer to Page 37 for more details.

Lap Timer

Allows the user to view details of each lap. To view all laps, go to the Lap List.

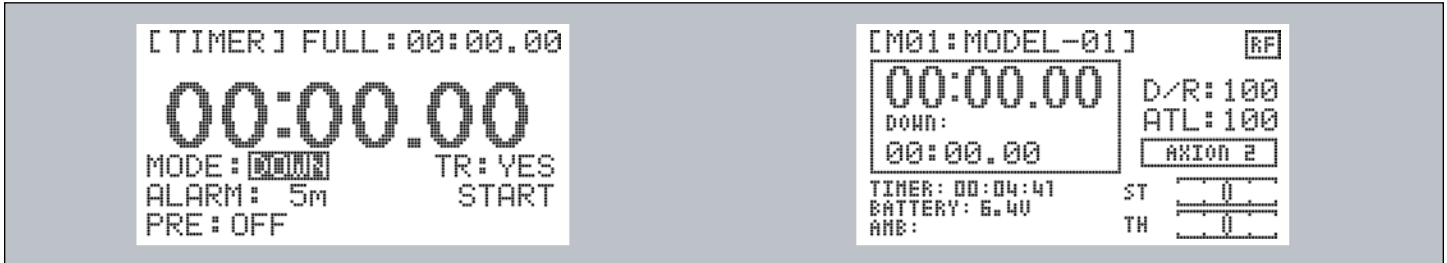

MODE: Select the desired timer function.

ALARM: Set the target alarm time.

PRE: Set a pre-alarm notification. For example, setting a 35 second pre-alarm will sound a warning 35 seconds before your start time.

TR: Activates the timer by moving the throttle trigger.

READY: Clicking Ready will start the timer.

RESET: Resets the timer.

1. Press the Main Dial button to access the function menu.
2. Select 'Timer' under the SET 2/2 tab.
3. Set up the timer function suitable to your needs.
4. Timer will start when you click 'READY' or pull the throttle trigger.



Note

Each lap can be stored by assigning a 'TIMER CAPTURE' switch. Refer to Page 37 for more details.

Lap List (Lap Time Listings)

The lap list stores average and individual lap times for later viewing.

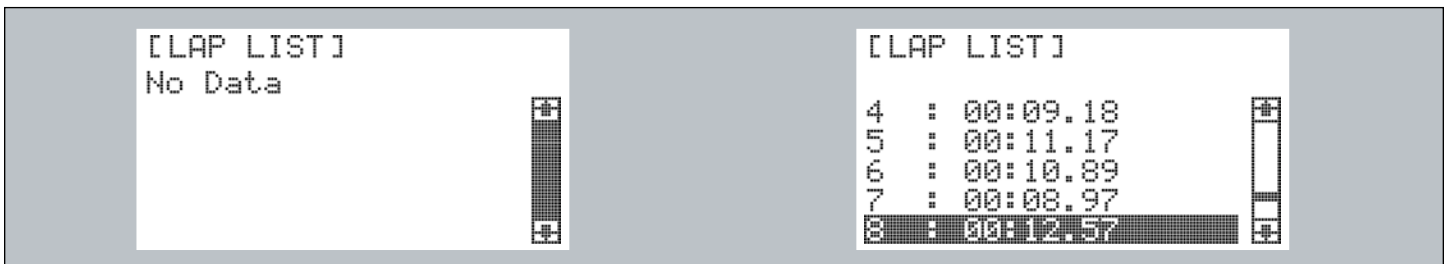

No Data: There is no LAP data available at this time.

AVG: Average lap time.

ALL: Total run time.

Lap List (Lap Time Listings cont.)

1. Press the Main Dial button to access the function menu.
2. Select 'Timer' under the SET 2/2 tab.
3. Check the Lap List by clicking the Main Dial over the highlighted option.



Note

The Lap List will be deleted upon restarting the Lap Timer or powering off.

Switch (Switch Functions, Assignments & Settings)

All switch functions and dials can be assigned under the Switch menu located on the Set 2/2 tab.

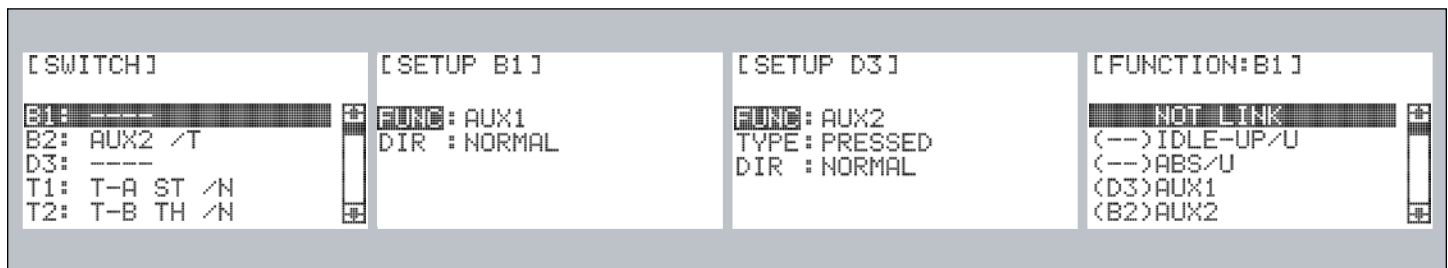

FUNG: Set the desired function that corresponds to your switches from a list of options.

DIR: May be set to normal or reverse or to ON/OFF for an assigned switch.

TYPE: An option for certain switches that defines the way to use them, either pressed or toggle.

TOGGLE: To activate the function, "toggle" the assigned switch.

PRESSED: If "pressed" is defined as the method of activation, pressing the switch will activate the corresponding function.

3SRATE: Press the switch to change the value for Minimum, Neutral, or Maximum rotation.

1. Press the Main Dial button to access the function menu.
2. Select 'SWITCH' under the SET 2/2 tab.
3. Scroll through the options with the Main Dial button. When the desired switch is highlighted, click the button to set up the parameters of that function.
4. Double check your switch buttons to ensure they were appropriately linked to the desired function before operating your model.



Note

There can only be one function assigned to each switch.

LYNX 4S MANUAL: SECTION 2

Assignable Switch List

Function	Switch Type												
	B1	B2	D3	T1	T2	T3	SW1	T1+	T2+	T3+	T1-	T2-	T3-
NOT LINK	O	O	O	O	O	O	O	O	O	O	O	O	O
4WS FS	X	X	X	X	X	X	X	O	O	O	O	O	O
4WS RS	X	X	X	X	X	X	X	O	O	O	O	O	O
4WS FR-N	X	X	X	X	X	X	X	O	O	O	O	O	O
4WS FR-S	X	X	X	X	X	X	X	O	O	O	O	O	O
4WS-S	O	O	O	O	O	O	X	X	X	X	X	X	X
4WS-3	X	O	O	O	O	O	O	X	X	X	X	X	X
TH-MIX	X	O	O	O	O	O	O	X	X	X	X	X	X
AUX1	O	O	O	O	O	O	O	X	X	X	X	X	X
AUX2	O	O	O	O	O	O	O	X	X	X	X	X	X
TELEVOICE/U	O	O	O	X	X	X	X	X	X	X	X	X	X
IDLE-UP/U	O	O	O	X	X	X	X	X	X	X	X	X	X
ABS/U	O	O	O	X	X	X	X	X	X	X	X	X	X
ST-EXP/U	O	O	O	X	X	X	X	X	X	X	X	X	X
BK-EXP/U	O	O	O	X	X	X	X	X	X	X	X	X	X
TH-EXP/U	O	O	O	X	X	X	X	X	X	X	X	X	X
TIMER START	X	O	O	X	X	X	X	X	X	X	X	X	X
TIMER CAPTURE	X	O	O	X	X	X	X	X	X	X	X	X	X
TIMER R/START	X	O	O	X	X	X	X	X	X	X	X	X	X
D/R	X	X	X	O	O	O	X	X	X	X	X	X	X
ATL	X	X	X	O	O	O	X	X	X	X	X	X	X
T-A ST	X	X	X	O	O	O	X	X	X	X	X	X	X
T-B TH	X	X	X	O	O	O	X	X	X	X	X	X	X
T-C AUX1	X	X	X	O	O	O	X	X	X	X	X	X	X
T-D AUX2	X	X	X	O	O	O	X	X	X	X	X	X	X
S-A ST	X	X	X	O	O	O	X	X	X	X	X	X	X
S-B TH	X	X	X	O	O	O	X	X	X	X	X	X	X
S-C AUX1	X	X	X	O	O	O	X	X	X	X	X	X	X
S-D AUX2	X	X	X	O	O	O	X	X	X	X	X	X	X
ST-SPD +	X	X	X	O	O	O	X	X	X	X	X	X	X
ST-SPD -	X	X	X	O	O	O	X	X	X	X	X	X	X
TH-SPD1	X	X	X	O	O	O	X	X	X	X	X	X	X
TH-SPD2	X	X	X	O	O	O	X	X	X	X	X	X	X
TH-SPD3	X	X	X	O	O	O	X	X	X	X	X	X	X
ST-EXP	X	X	X	O	O	O	X	X	X	X	X	X	X
BK-EXP	X	X	X	O	O	O	X	X	X	X	X	X	X
TH-EXP	X	X	X	O	O	O	X	X	X	X	X	X	X
T-A F-ST	X	X	X	O	O	O	X	X	X	X	X	X	X
T-B F-TH	X	X	X	O	O	O	X	X	X	X	X	X	X
T-C R-ST	X	X	X	O	O	O	X	X	X	X	X	X	X
T-D R-TH	X	X	X	O	O	O	X	X	X	X	X	X	X
S-A F-ST	X	X	X	O	O	O	X	X	X	X	X	X	X
S-B F-TH	X	X	X	O	O	O	X	X	X	X	X	X	X
S-C R-ST	X	X	X	O	O	O	X	X	X	X	X	X	X
S-D R-TH	X	X	X	O	O	O	X	X	X	X	X	X	X
T-ST	X	X	X	O	O	O	X	X	X	X	X	X	X
T-TH	X	X	X	O	O	O	X	X	X	X	X	X	X

Function of Switch

Function	Description
NOT LINK	Clear Assigned function
4WS FS	Change to Front Wheel Steer
4WS RS	Change to Rear Wheel Steer
4WS FR-N	Change to Front and Rear Steer
4WS FR-S	Change to Front and Rear Steer (Same Phase)
4WS-S	Change to Rear Steer or Back to 4WS-3 Status
4WS-3	Change Status 4WS FR-N/4WS FR-S/4WS FS
TH-MIX	Front Motor, Rear Motor can be controlled at the same time or seperately
AUX1	Control 3CH servo from the receiver
AUX2	Control 4CH servo from the receiver
TELEVOICE/U	Turn On/Off Telemetry voice
IDLE-UP/U	Turn On/Off IDLE-UP
ABS/U	Turn On/Off ABS
ST-EXP/U	Turn On/Off ST-EXP
BK-EXP/U	Turn On/Off BK-EXP
TH-EXP/U	Turn On/Off TH-EXP
TIMER START	Start/Stop Timer
TIMER CAPTURE	Record each Lap in LAP TIMER
TIMER R/START	Start/Reset Timer
D/R	Dual Rate
ATL	ATL
T-A ST	Adjust 1CH Trim
T-B TH	Adjust 2CH Trim
T-C AUX1	Adjust 3CH Trim
T-D AUX2	Adjust 4CH Trim
S-A ST	Adjust 1CH Sub-Trim
S-B TH	Adjust 2CH Sub-Trim
S-C AUX1	Adjust 3CH Sub-Trim
S-D AUX2	Adjust 4CH Sub-Trim
ST-SPD +	Change 'TURN' Servo Speed
ST-SPD -	Change 'RETURN' Servo Speed
TH-SPD1	Change 'LOW' value on 3 Step Throttle Servo Speed
TH-SPD2	Change 'MID' value on 4 Step Throttle Servo Speed
TH-SPD3	Change 'HIGH' value on 5 Step Throttle Servo Speed
ST-EXP	Change ST-EXP
BK-EXP	Change BK-EXP
TH-EXP	Change '[MODE: EXP]' Value on TH-EXP
T-A F-ST	Change Trim of Front Steering on 4WS
T-B F-TH	Change Trim of Front ESC on 4WS
T-C R-ST	Change Trim of Rear Steering on 4WS
T-D R-TH	Change Trim of Rear ESC on 4WS
S-A F-ST	Change Sub-Trim of Front Steering on 4WS
S-B F-TH	Change Sub-Trim of Front ESC on 4WS
S-C R-ST	Change Sub-Trim of Rear Steering on 4WS
S-D R-TH	Change Sub-Trim of Rear ESC on 4WS
T-ST	Change Trim of Front and Rear Steering at the same time on 4WS
T-TH	Change Trim of Front and Rear ESC at the same time on 4WS

Dial (Radio Dial Functions & Settings)

There are three dial positions that you may link to an R/C function of your choosing.

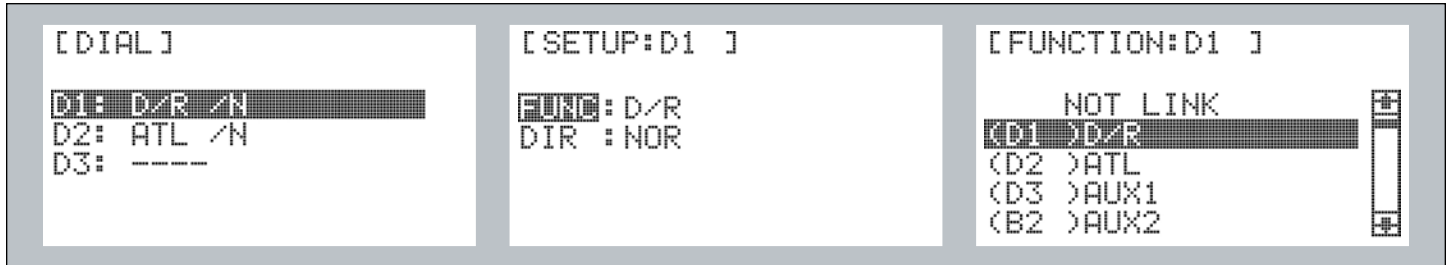

FUNC: Type of Function

DIR: Set to Normal /Reverse or ON/OFF.

1. Press the Main Dial button to enter the function menu.
2. Select 'Dial ' under the SET 2/2 tab.
3. Use the Main Dial button to select and assign the Dial options.
4. Once set-up is complete, please double check the assigned switch before operation.



Note

There is only one function for every switch.

Dial Function

	D1	D2	D3
Function	Switch Type		
NOT LINK	0	0	0
AUX1	0	0	0
AUX2	0	0	0
D/R	0	0	0
ATL	0	0	0
T-A ST	0	0	0
T-B TH	0	0	0
T-C AUX1	0	0	0
T-D AUX2	0	0	0
S-A ST	0	0	0
S-B TH	0	0	0
S-C AUX1	0	0	0
S-D AUX2	0	0	0
ST-SPD +	0	0	0
ST-SPD -	0	0	0
TH-SPD1	0	0	0
TH-SPD2	0	0	0
TH-SPD3	0	0	0
ST-EXP	0	0	0
BK-EXP	0	0	0
TH-EXP	0	0	0
T-A F-ST	0	0	0
T-B F-TH	0	0	0
T-C R-ST	0	0	0
T-D R-TH	0	0	0
S-A F-ST	0	0	0
S-B F-TH	0	0	0
S-C R-ST	0	0	0
S-D R-TH	0	0	0
T-ST	0	0	0
T-TH	0	0	0



Note

Depending on MIX type, Dial set-up may be limited.

Mix (Channel Mixing)

The Lynx 4S provides 11 different mixing commands suitable to your R/C needs.

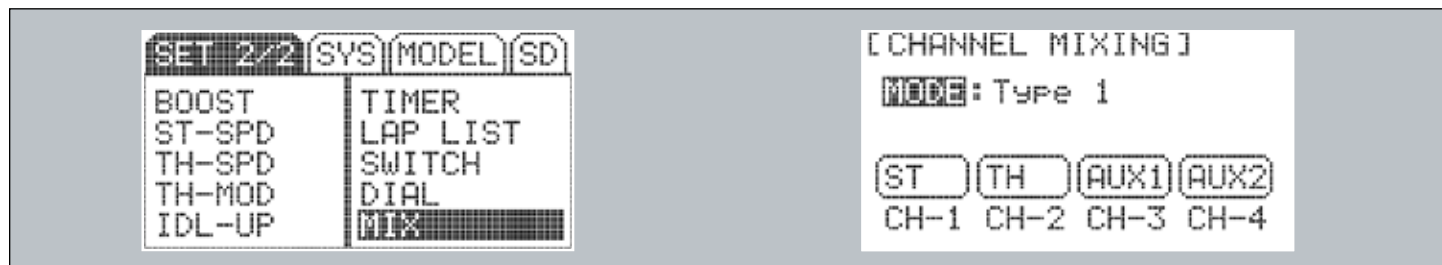

1. Press the Main Dial button to access the function menu.
2. Select 'MIX' under the SET 2/2 tab.
3. Select the type of Mixing command by using the Main Dial button.
4. Changes will be saved after you exit the MIX set-up screen.



Note

Be careful to select the appropriate MIX type as it may cause damage to your equipment if set up incorrectly.

Type of Mixing

	TYPE 1	TYPE 2	TYPE 3	TYPE 4	TYPE 5	TYPE 6	TYPE 7	TYPE 8	TYPE 9	TYPE 10T	YPE 11
CH	Normal	1/5 Scale Gas Car						4WSC	rawler	Dual Throttle 4WS	Boat
CH1S	teeringS	teeringS	teeringS	teering	Left / Steering	Left / Steering	Left / Steering	Front / Steering	Steering	Front / Steering	Left / Steering
CH2	Throttle / Brake	Throttle	Throttle / Brake	Throttle	Throttle / Brake	Throttle	Throttle / Brake	Throttle / Brake	Front / Throttle / Brake	Front / Throttle / Brake	Throttle
CH3A	UX 1	Brake	Brake	Brake 1	Right / Steering	Right / Steering	Right / Steering	Rear / Steering	Rear / Throttle / Brake	Rear / Steering	Right / Steering
CH4A	UX 2	AUX 1A	UX 1	Brake 2	AUX 1B	rake	Brake	AUX 1A	UX 1	Rear / Throttle / Brake	AUX 2

No Data: There is no LAP data available at this time.

AVG: Average lap time.

ALL: Total run time.

4WS (4 Wheel Steering)

The Lynx 4S allows the user to control both front and rear steering either together or independently. You can control the 4WS system using TYPE 8 or TYPE 10 along with 11 different mix commands. You can assign control of the 4WS front/rear steering to a switch button if desired.

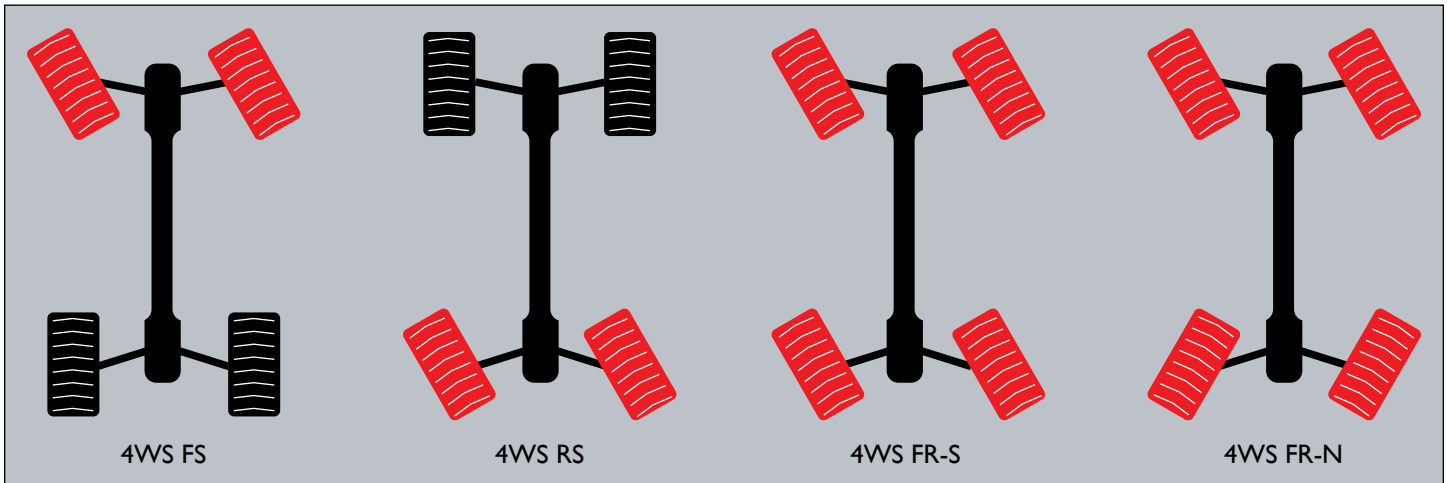

Crawler

A function that controls Dual ESC. You can control a Dual ESC system using TYPE 9 or TYPE 10 along with 11 different mix commands. You also have the option of assigning a control switch to this function.

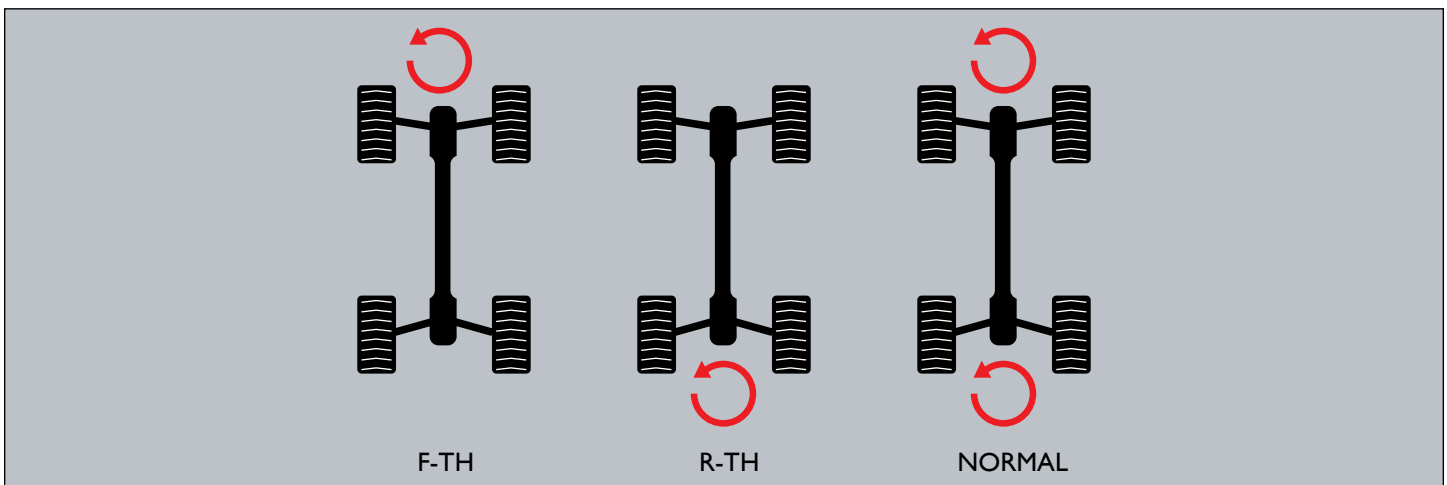

ST-ADJ (Steering Adjustments)

Use this function when a mechanical steering offset has occurred.

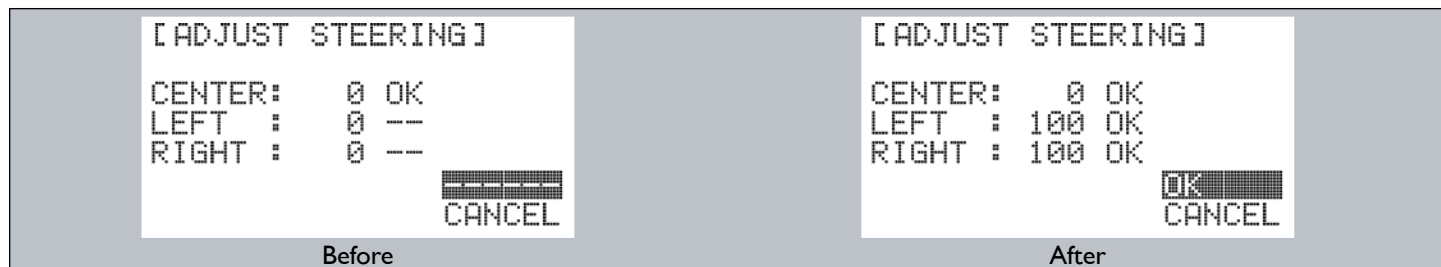

1. Press the Main Dial button to access the function menu.
2. Select 'ST-ADJ' under the SYSTEM tab.
3. Turn the steering wheel left or right to adjust the corresponding values. A reading of "0 OK" represents Center.
4. If you have an OK marker on the screen, press OK to save.



Note

Once ST-ADJ is complete, please double check the throttle setup to ensure proper operation.

TH-ADJ (Throttle Adjustments)

Use this function to tweak your throttle setting.

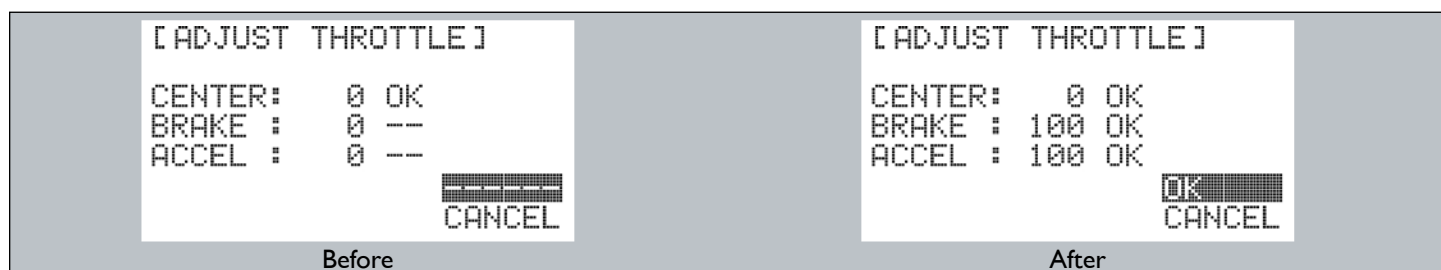

1. Press the Main Dial button to access the function menu.
2. Select 'TH-ADJ' under the SYSTEM tab.
3. Press the throttle trigger to adjust the values on-screen. A reading of "0 OK" represents neutral.
4. If you have an OK marker on the screen, press OK to save.



Note

Once TH-ADJ is complete, please double check the throttle setup to ensure proper operation.

RX-Bind (Receiver Binding)

Use the RX-BIND process when you have purchased multiple receivers or need to reset those receivers from a previous bind. RX-BIND “binds” the transmitter to the receiver so they operate as a unit pair.

The Lynx 4S stores up to 30 models in its memory, which means users can bind up to 30 receivers to their Lynx 4S and control each one of them independently.



Note

Please place the Lynx 4S and receiver(s) within a 1 meter distance while binding.

```
[RX-BIND]
RX-MODEL: AXION 2
RESPONSE: HHR SYSTEM
(ONLY DIGITAL SERVOS)
START
```

Bind with AXION 2

```
[RX-BIND]
RX-MODEL: PROTON 4
RESPONSE: NORMAL
(ALL SERVOS)
START
```

Bind with PROTON 4

The Lynx 4S is only compatible with Hitec AFHSS Surface Receivers. Please select the appropriate receiver according to your receiver type.

AXION 2: Will bind with AXION 2

AXION 4: Will bind with AXION 4

PROTON 4: Will bind with PROTON 4

NORMAL: 14ms (Digital / Analog servo compatible)

HIGH SPEED: 7ms (Only compatible with Digital servo)

HHR SYSTEM: 4ms (Only compatible with Digital servo & Axion 2)



Note

Prevent serious damage to analog servos; DO NOT SELECT HIGH SPEED OR HHR SYSTEM with analog servo receivers.

```
[RX-BIND]
RX-MODEL: AXION 2
RESPONSE: HHR SYSTEM
(ONLY DIGITAL SERVOS)
START
```

Ex) Bind with AXION 2

```
[RX-BIND]
RX-MODEL: AXION 2
RESPONSE: HHR SYSTEM
(ONLY DIGITAL SERVOS)
BINDING
```

Ex) Bind with PROTON 4

RX-Bind (Receiver Binding cont.)

Lynx 4S Bind Process:

1. Press the Main Dial button to access the function menu.
2. Select 'RX-BIND' located under the SYSTEM tab.
3. Select the correct receiver.
4. Click 'START' at the bottom of the screen. Note that it will now read "BINDING."
5. The bind is complete when the LED on the transmitter flashes in color.

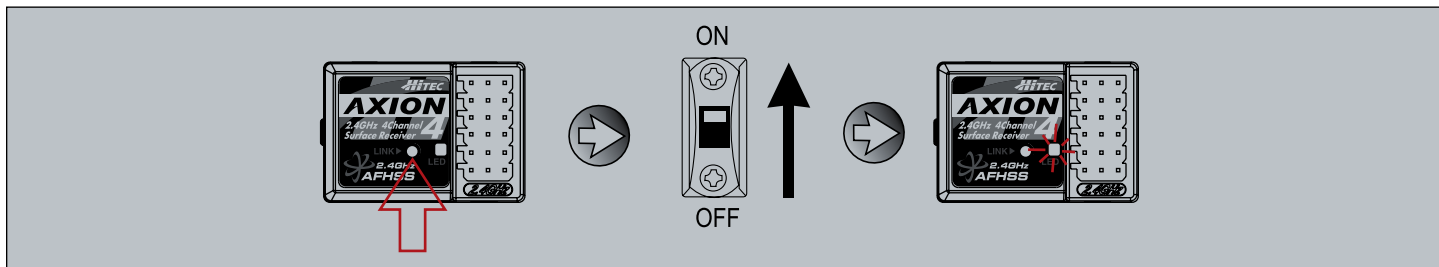

Receiver Bind Process (same as AXION and PROTON):

1. Prepare the Lynx 4S for binding.
2. Press the 'LINK' button on the receiver and turn the power ON.
3. Once the power is on, release the 'LINK' button.
4. Look for a blinking red and blue LED.
5. Binding is complete when the LED glows solidly blue.
6. Press the ESC button on the transmitter twice to leave bind mode.
7. Power your receiver OFF and then back ON to check for binding.



Note

Repeat the steps above if binding does not take.

RF-Scan (Radio Frequency Scanning)

This function improves the signal connection between your transmitter and receiver. It is highly recommended that you use the RF-SCAN function when operating your model in a new location.



Note

RF-SCAN clears all bind data. Once the RF-SCAN is complete, you will need to re-process the TX/RX bind.

RF-Scan (Radio Frequency Scanning cont.)

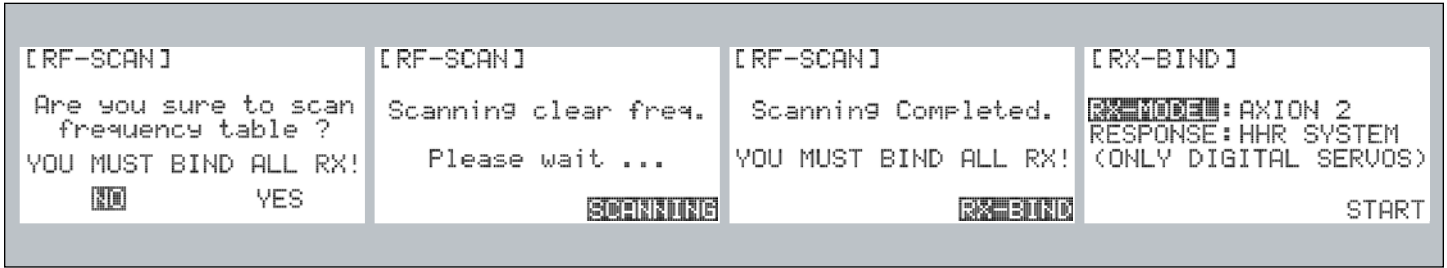

1. Press the Main Dial button to access the function menu.
2. Select 'RF-SCAN' under the SYSTEM tab.
3. Press 'YES' to begin the scan.
4. Once scanning is complete, you will need to recreate the bind between your transmitter and any receivers.

Servo (Servo Monitor)

All servo operations can be checked by graph on-screen using the 'TEST' function to assess their condition. The number assigned to the TEST value relates to test speed.

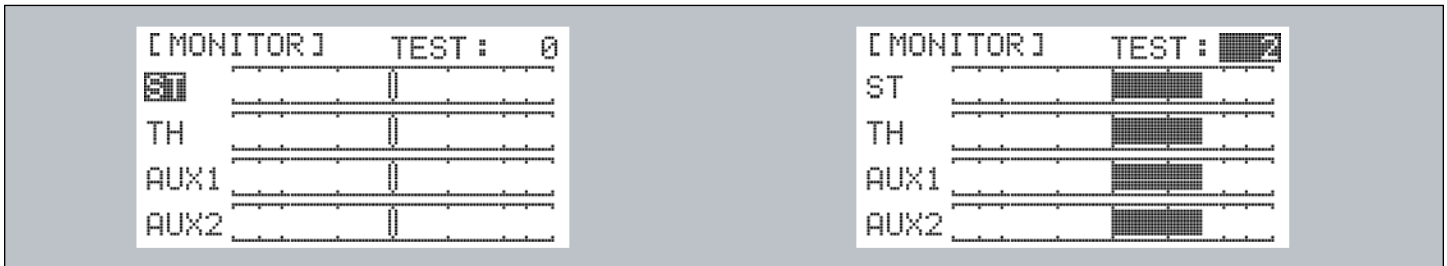

1. Press the Main Dial button to access the function menu.
2. Select 'SERVO' under the SYSTEM tab.
3. Move all servos connected with the receiver to check their condition.
4. You can adjust 'TEST' speed by changing the numbers next to 'TEST'.



Note

Please DO NOT activate the 'TEST' function if the servos are already installed in the vehicle as it may cause damage to the model or servo failure.

Sensor (Telemetry Sensor Setup)

Hitec's AFHSS (Advanced Frequency Hopping Spread Spectrum) is supported by bi-directional communication known as telemetry. With this function, users can check the data output of the telemetry sensors on-screen and activate warnings to sound from the Lynx 4S speakers or earphone port.



Note

The telemetry function is only compatible with a PROTON 4 receiver.

Sensor (Telemetry Sensor Setup cont.)

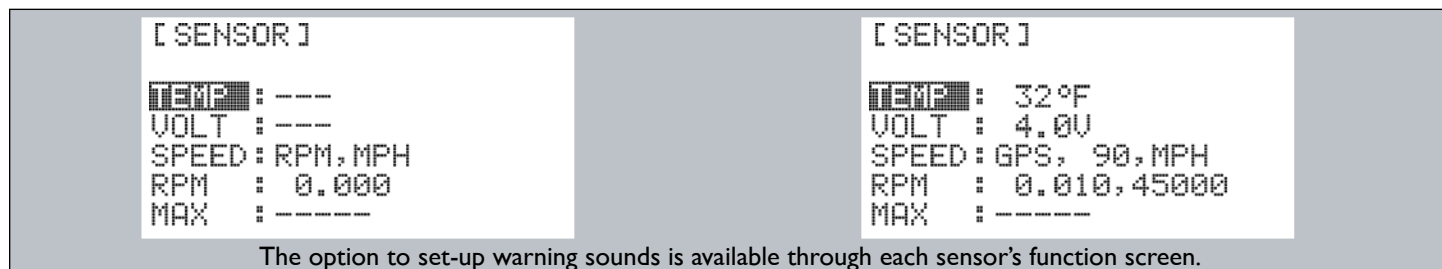

TEMP (Temperature Sensor):

Temperature data gathered by the temperature sensor is displayed on-screen. Users can also set a warning level and spoken audio warning for this function.

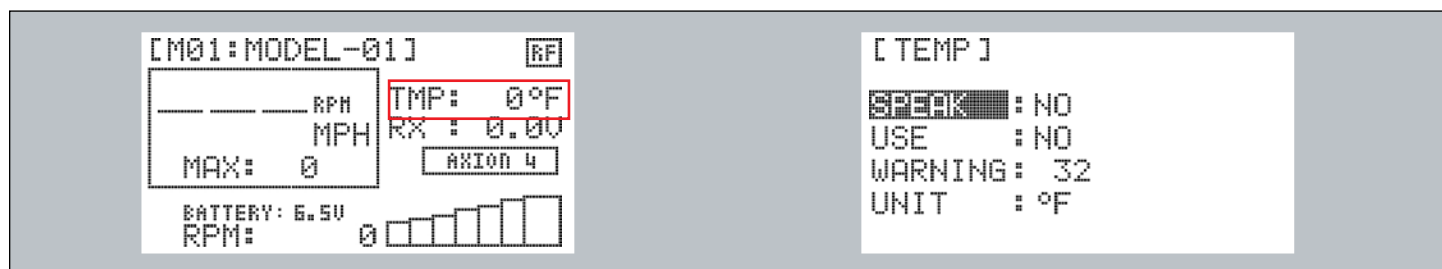

TMP: Temperature via TEMP sensor.



SPEAK: Activate to issue an audio warning via the Lynx 4S speakers.

USE: Issues a warning message when activated.

WARNING: Set the desired warning level.

UNIT: Set the unit of temperature (F or C).

1. Press the Main Dial to access the function menu.
2. Select 'SERVO' under the SYSTEM tab.
3. Select 'TEMP' from the menu and adjust the options to your preference.

-  This function is only available when the temperature sensor is connected to your Proton 4 receiver.
-  To use the 'SPEAK' function, a micro SD memory card is required. It is recommended that users save their warning files to the micro SD memory card provided through the Hitec website. Please visit page XX for more details.
-  There will be a time delay between the read-out of the audio data and when the data is displayed on-screen.

Sensor (Telemetry Sensor Setup cont.)

VOLT (Voltage Sensor):

Data from the voltage sensor will be displayed on-screen. In this section, users are shown how to set a VOLT warning level and voice output.

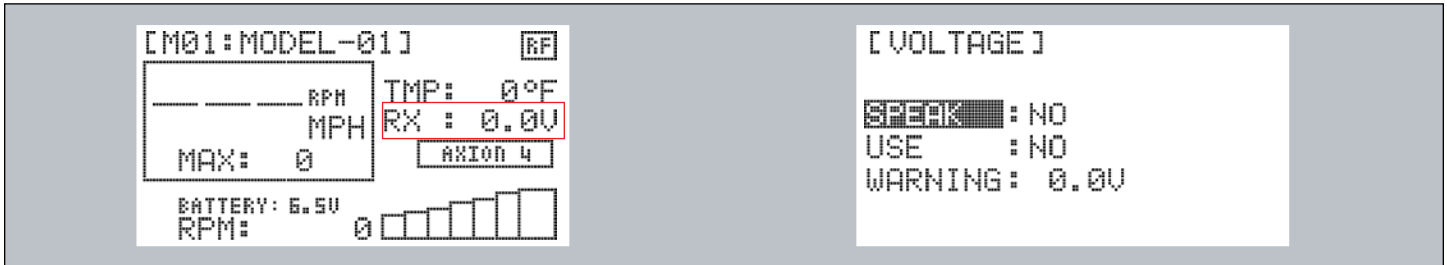

SPEAK: Activate to issue an audio warning via the Lynx 4S speakers.

USE: Issues a warning message when activated.

WARNING: Set the desired warning level.

1. Press the Main Dial to access the function menu.
2. Select 'SERVO' under the SYSTEM tab.
3. Select 'VOLT' from the menu and adjust the options to your preference.

In order to check voltage on a battery higher than 8.4V, you will need to connect the battery to the SPC port of the PROTON 4 receiver. A battery under 8.4V can be checked automatically if it is connected to the receiver or ESC. For more information, please refer to page _____.



Note

This function is only available when a Proton 4 receiver is used.



Note

To use the 'SPEAK' function, a micro SD memory card is required. It is recommended that users save their warning files to the micro SD memory card provided through the Hitec website. Please visit page _____ for more details.



Note

There will be a time delay between the read-out of the audio data and when the data is displayed on-screen.

Sensor (Telemetry Sensor Setup cont.)

SPEED (GPS or RPM Sensor):

Data from your GPS or RPM sensor will be displayed on-screen. In this section, users are shown how to set a SPEED warning level and voice output.

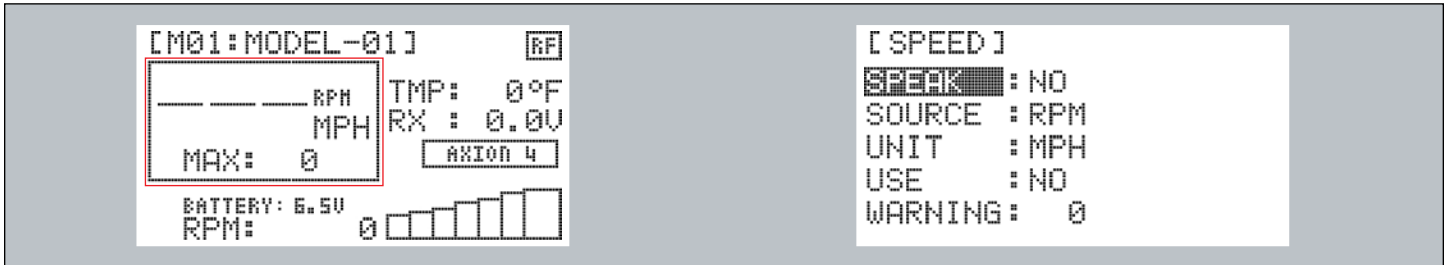

SPEAK: Activate to issue an audio warning via the Lynx 4S speakers.

SOURCE: Users have two options, GPS or RPM.

UNIT: Set the unit of speed (MPH or KPH).

USE: Issues a warning message when activated.

WARNING: Set the desired warning level.

1. Press Main Dial to access the function menu.
2. Select 'SERVO' under the SYSTEM tab.
3. Select 'SPEED' from the menu and adjust the options to your preference.



Note

This function is only available when a Proton 4 receiver is used.



Note

The GPS sensor is unavailable indoors. Please note that there may be a difference between GPS speed and actual speed depending on mileage.



Note

To use the 'SPEAK' function, a micro SD memory card is required. It is recommended that users save their warning files to the micro SD memory card provided through the Hitec website. Please visit page _____ for more details.



Note

There will be a time delay between the read-out of the audio data and when the data is displayed on-screen.

Sensor (Telemetry Sensor Setup cont.)

RPM (Magnetic RPM Sensor):

Data from the RPM sensor will be displayed on-screen. In this section, users are shown how to set an RPM warning level and voice output.

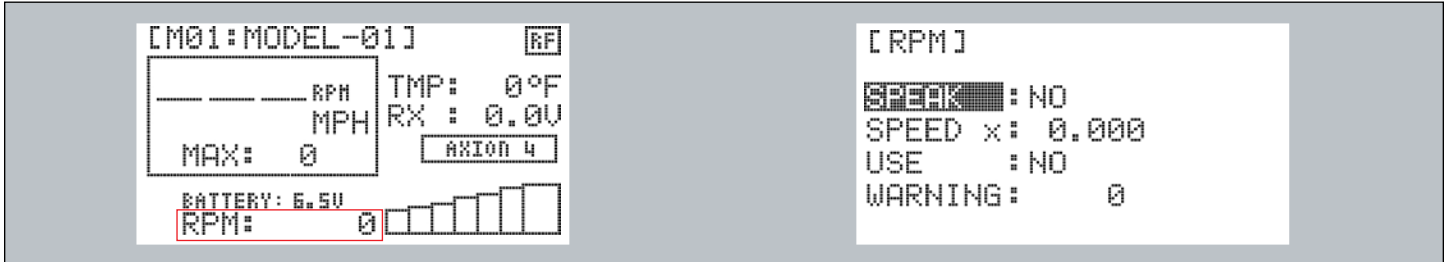

SPEAK: Activate to issue an audio warning via the Lynx 4S speakers.

SPEED: Set gear ratios so that the data from RPM sensor can be converted to the speed (Km/h).

USE: Issues a warning message when activated.

WARNING: Set the desired warning level.

1. Press the Main Dial to access the function menu.
2. Select 'SERVO' under the SYSTEM tab.
3. Select 'RPM' from the menu and adjust the options to your preference.



Note

This function is only available when the RPM sensor is connected to a Proton 4 receiver.



Note

To use the 'SPEAK' function, a micro SD memory card is required. It is recommended that users save their warning files to the micro SD memory card provided through the Hitec website. Please visit page _____ for more details. There will be a time delay between the read-out of the audio data and when the data is displayed on-screen.

MAX (Maximum Speed Reset):

Sets the maximum speed.

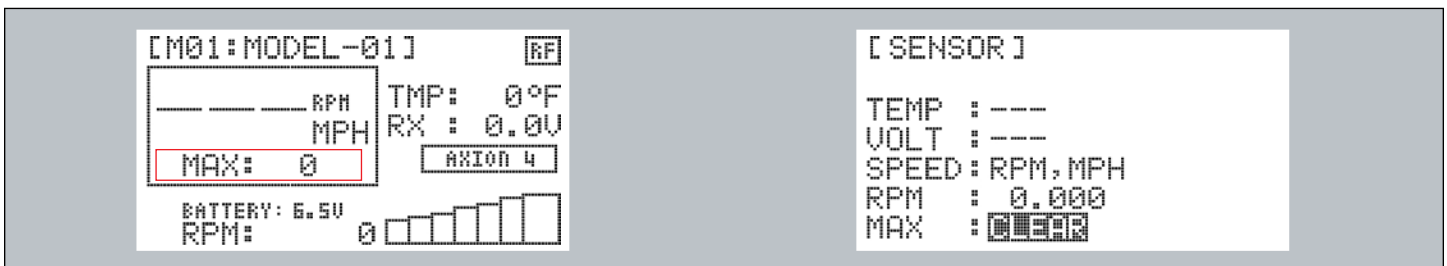

1. Press the Main Dial button to access the function menu.
2. Select 'SERVO' under the SYSTEM tab.
3. Select 'MAX' on the menu to set the maximum speed.

Management (Radio System Management Settings)

The Lynx 4S transmitter offers numerous customizable settings so that users can maximize comfort and convenience.

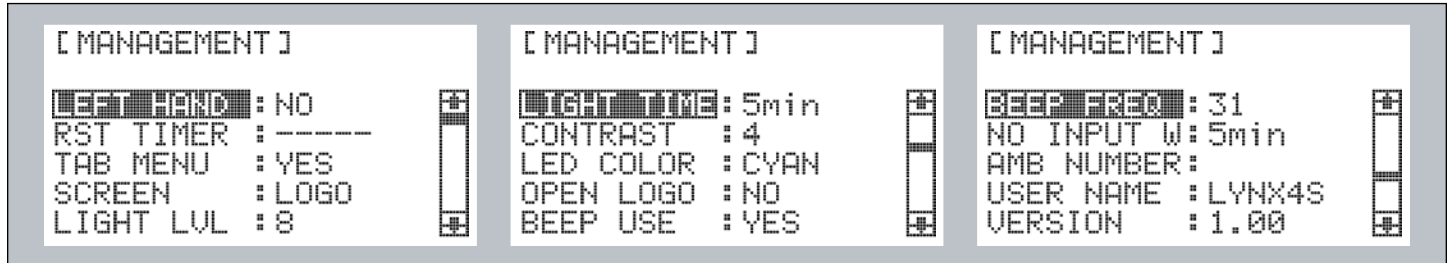

LEFT HAND: The main screen turns 180 degrees for left-handed users.

RST TIMER: Displays usage time on the main screen.

TAB MENU: Requires the user to click each tab heading in the function menu to access the options below. When turned off, the user can scroll through the tabs and their options fluidly.

SCREEN: Set the information on the secondary screen.
(Users can choose from the following: LOGO, USERNAME, TIMER or OUTPUT).

LIGHT LVL: Set the brightness of the back light (Level 1 to 10).

LIGHT TIME: Dim the back light after a predetermined time.

CONTRAST: Sets the contrast of the LCD (Level 1 to 8).

LED COLOR: Sets the color of the LCD from 6 available options.

OPEN LOGO: Displays the Hitec logo when the Lynx 4S powers ON.

BEEP USE: Either ON or OFF.

BEEP FREQ: Adjusts the volume of the beep sound.

NO INPUT: In order to save battery life, the transmitter will issue a warning when powered ON but not used for a predetermined amount of time.

AMB NUMBER: Save the AMB numbers for each model.

USER NAME: Sets the user name.

VERSION: Shows the current firmware version.

Telemetry (Telemetry Display)

The main screen always displays certain information throughout the operation of your model. The information on-screen will change according to the data output from each sensor.

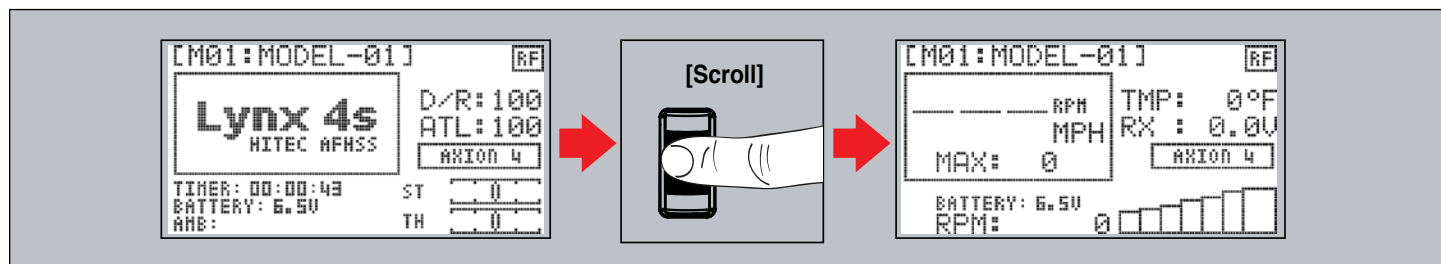

Note

Telemetry data appears when scrolling the main dial button up or down from the main screen.

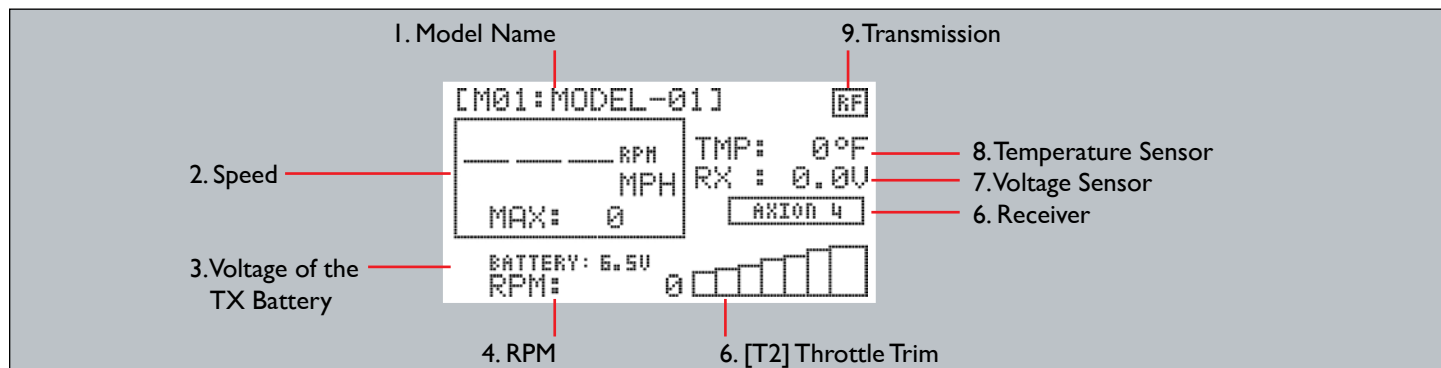

- 1. Model Name:** Shows the current model name and number.
- 2. Speed:** Shows speed measured from the GPS or RPM sensor.
- 3. TX Battery Voltage:** Shows the voltage of the transmitter battery.
- 4. RPM:** Shows RPMs measured from the RPM sensor.
- 5. Throttle Trigger Gauge:** Shows the control value of the trigger.
- 6. Receiver:** Shows receiver type and the status of the boost function.
- 7. Voltage Sensors:** Shows the voltage value as measured by the voltage sensor.
- 8. Temperature Sensors:** Shows temperature value as measured by the temperature sensor.
- 9. Transmission:** Shows the status of the transmission.

Vibration

The Lynx 4S has a built-in vibration motor, which can be activated to issue driving and noise warnings.

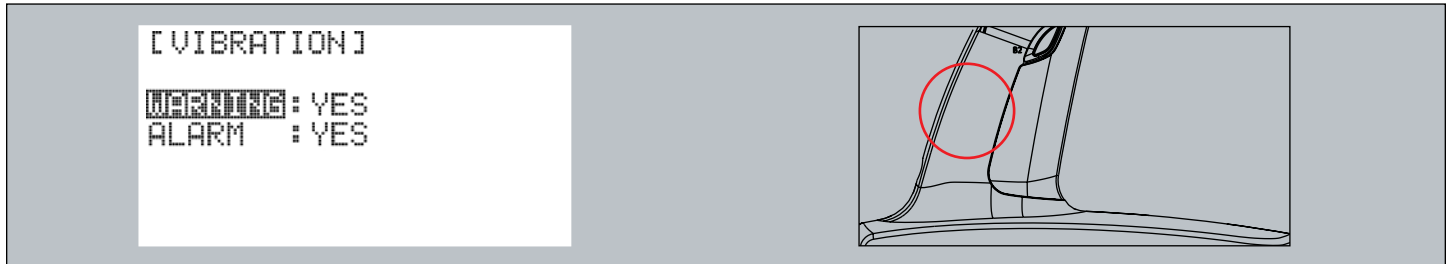

1. Press the Main Dial button to access the function menu.
2. Select 'VIBRATION' under the SYSTEM tab.
3. Highlight and then click the function to turn it on or off as desired.



Note

When the vibration function is on, the sound function automatically turns off in order to save the speaker's sound quality.

Battery (Battery Type Settings)

The Lynx 4S includes a Ni-MH battery and can be used with a Ni-CD, Li-Po, or Li-Fe battery. When the type of battery is changed, the Lynx 4S will automatically manage the new voltage system as shown below.

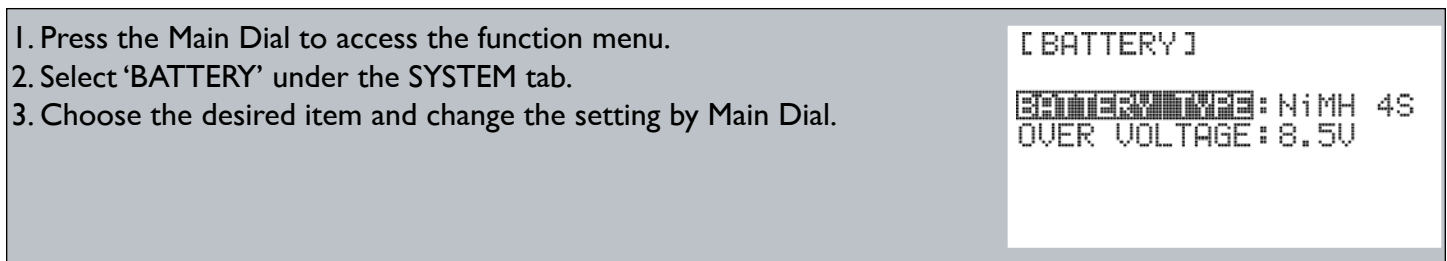

Note

Be sure to set the correct battery type. If the wrong battery type is defined, damage to the battery may occur.

Name (Model Naming)

Users can create up to 12 model names. These names are shown on the main screen.

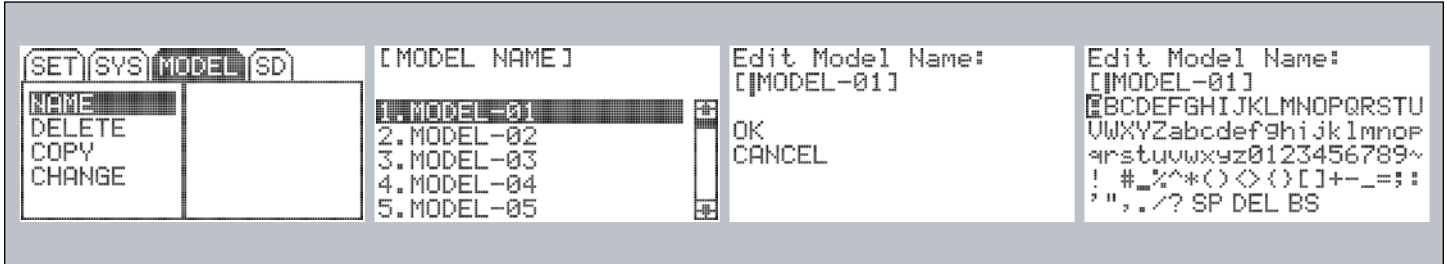

1. Press the Main Dial button to access the function menu.
2. Select 'NAME' under the MODEL tab.
3. Spell out the name of your choice by using the on-screen cursor and keyboard.



Note

Users can save the names of each model.

Delete (Model Delete)

Users can delete model names and their settings.

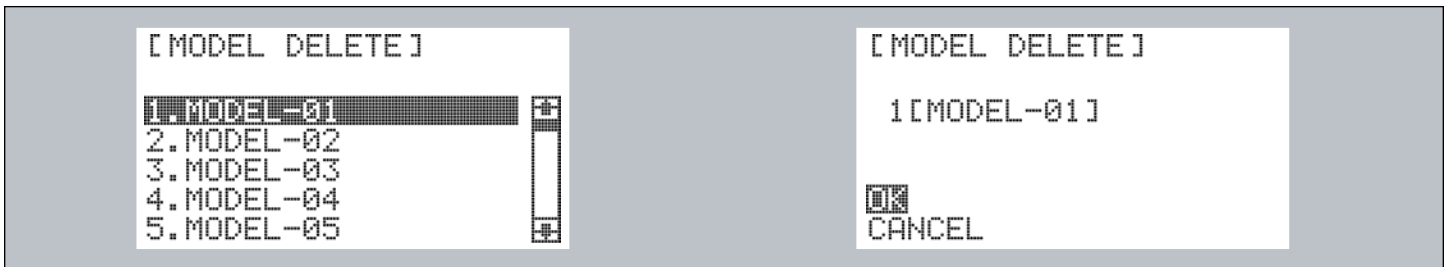

1. Press the Main Dial button to access the function menu.
2. Select 'DELETE' under the MODEL tab.
3. Choose the model you want to delete.



Note

The active model cannot be deleted. You will need to activate a different model before selecting the model you want to delete.

Copy (Model Copy)

The model name and its corresponding settings can be duplicated under a new model.

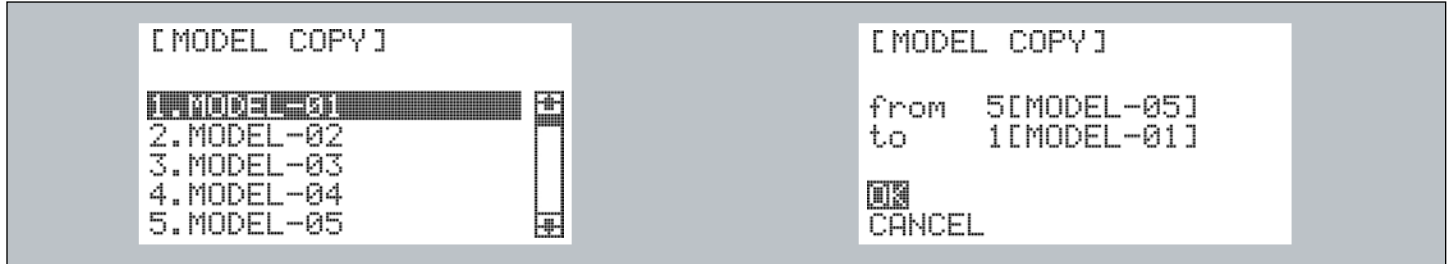

1. Press the Main Dial button to access the function menu.
2. Select 'COPY' under the MODEL tab.
3. Select the model to be copied.



Note

When you copy a model, the settings of the original model are deleted.

Change (Active Model Selection)

Any model not currently in use can be changed.

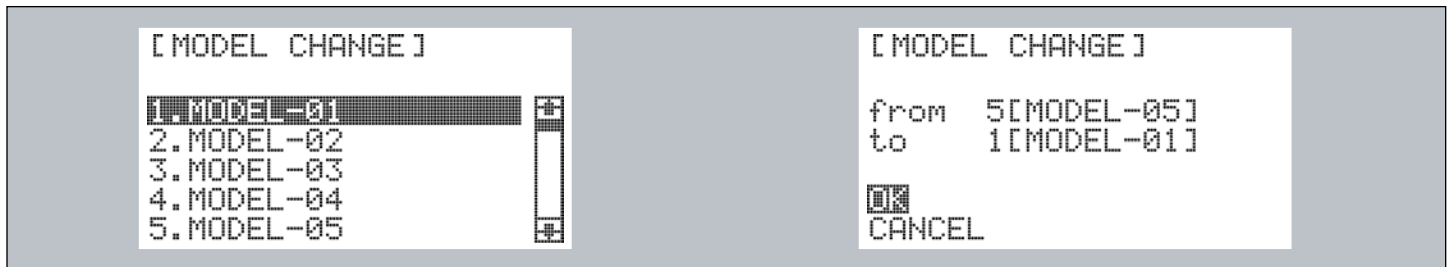

1. Press the Main Dial button to access the function menu.
2. Select 'CHANGE' under the MODEL tab.
3. Select the model you want to change to.

SD-Name (SD Card Model Naming)

30 additional model names can be stored with the use of an SD card.

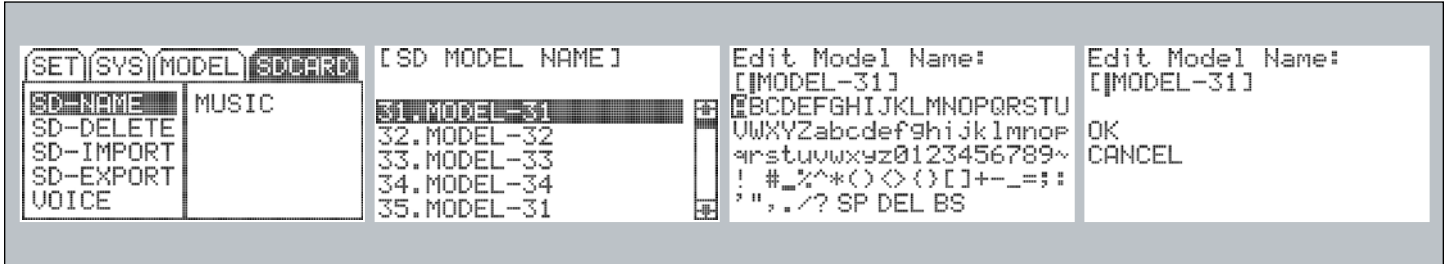

1. Press the Main Dial button to access the function menu.
2. Select 'SD-NAME' under the MODEL tab (SD-MODEL).
3. Change the setting by using the on-screen keyboard.



Note

To prevent an error from occurring, please do not remove the SD card when using this function.

SD Delete (SD Card Model Delete)

Users can clear the SD Card of any stored model data.

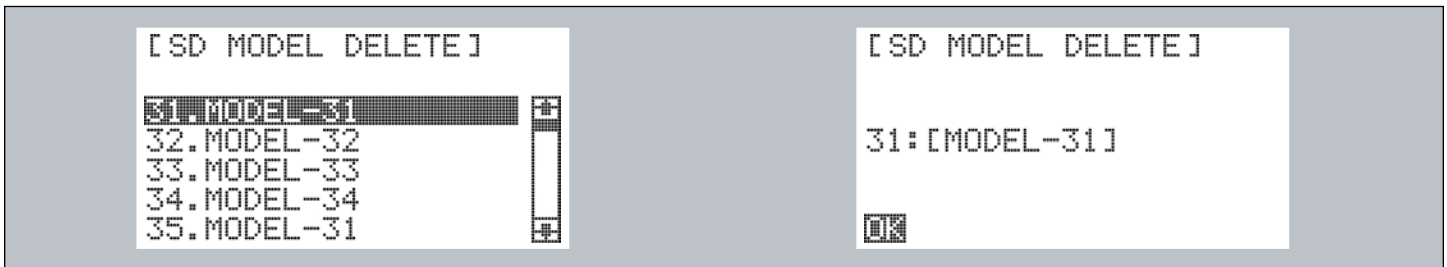

1. Press the Main Dial button to access the function menu.
2. Select 'SD-DELETE' under the MODEL tab (SD-MODEL).
3. Select the model you wish to delete.



Note

To prevent an error from occurring please do not remove the SD card when using this function.



Note

The active model cannot be deleted. You will need to activate a different model before selecting the model you want to delete.

SD Import (SD Card Model Import)

Model data that has been saved to the SD card can be imported to your transmitter.

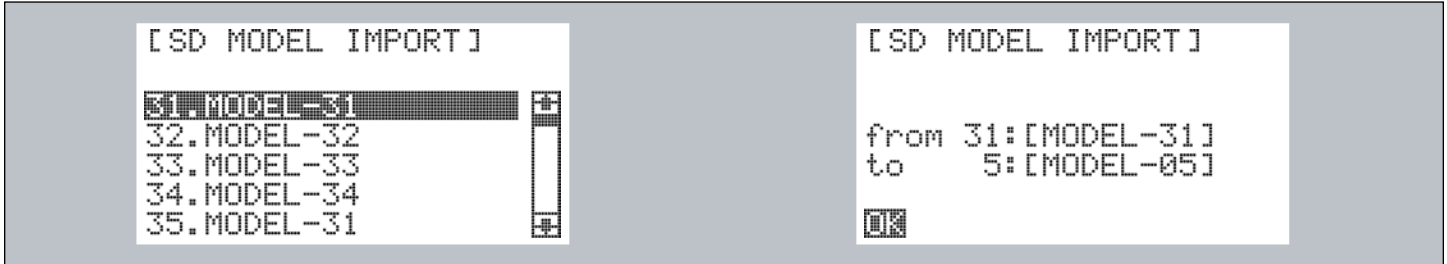

1. Press the Main Dial button to access the function menu.
2. Select 'SD-IMPORT' under the MODEL tab (SD-MODEL).
3. Select the model that you want to import from the SD card.



Note

The current model data in the transmitter will be deleted.



Note

To prevent an error from occurring, please do not remove the SD card when using this function.

SD Export (SD Card Model Export)

Model data stored in the transmitter can be exported to the SD card.

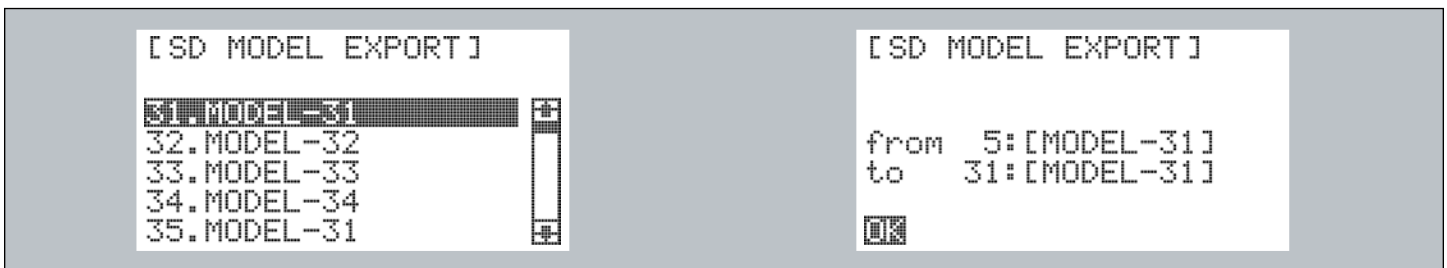

1. Press the Main Dial button to access the function menu.
2. Select 'SD-EXPORT' under the MODEL tab (SD-MODEL).
3. Select the model that you want to export to the SD card.



Note

To prevent an error from occurring, please do not remove the SD card when using this function.



Note

The current model data on the SD card will be deleted.

Voice (Voice Function)

The Lynx 4S can read sensor data outloud. Users can also assign a warning message by using a wave file.



Note

This function can be used with a micro SD card, the bidirectional audio output file offered by Hitec, a wave conversion program, or a wave file. For more information, please visit our website at www.hitecrd.com.

```
[SETUP TO VOICE]
```

```
VOLUME : MAX
TELEMETRY : YES
BAT OVER : NO
BAT LOW : NO
NO INPUT W : NO
```

```
[SETUP TO VOICE]
```

```
TELEMETRY : YES
BAT OVER : NO
BAT LOW : NO
NO INPUT W : NO
POWER ON : YES
```

VOLUME: Adjusts the level of sound from the speaker

TELEMETRY: Turns on or off the voice output for the bidirectional telemetry sensors

BAT OVER: Turns on or off the wave file output for excessive battery voltage.

BAT LOW: Turns on or off the wave file output for low battery voltage.

NO INPUT W: To save battery, the transmitter can emit a warning message when it's powered ON but hasn't been used for a predetermined amount of time.

POWER ON: The wave file can be turned on or off when the power is on.



Note

When the vibration function is on, speakers turn off. Please check your vibration settings.

Music (Music Play)

The Lynx 4S can play music from wave files. Users can opt to listen to music with earphones.



Note

This function can be used with a micro SD card, the wave conversion program offered by Hitec, or music files. For more information, please visit our website at www.hitecrd.com.

Music (Music Play cont.)

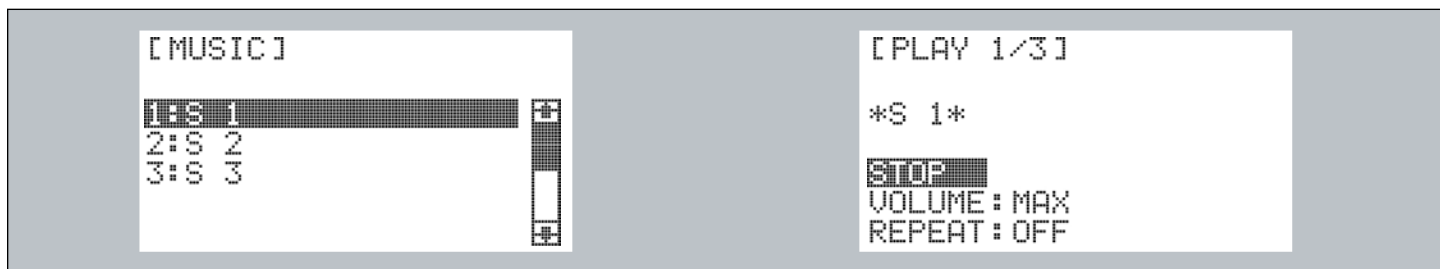

VOLUME: Adjusts the music sound from the speaker.

REPEAT: Allows users to determine repetition of a song (repeat one song, whole repeat, or play one song).



Note

Playing music may drain batteries more quickly.

Warning & Error Messages

Users should familiarize themselves with the various warning messages of the Lynx 4S in order to operate the system most effectively.

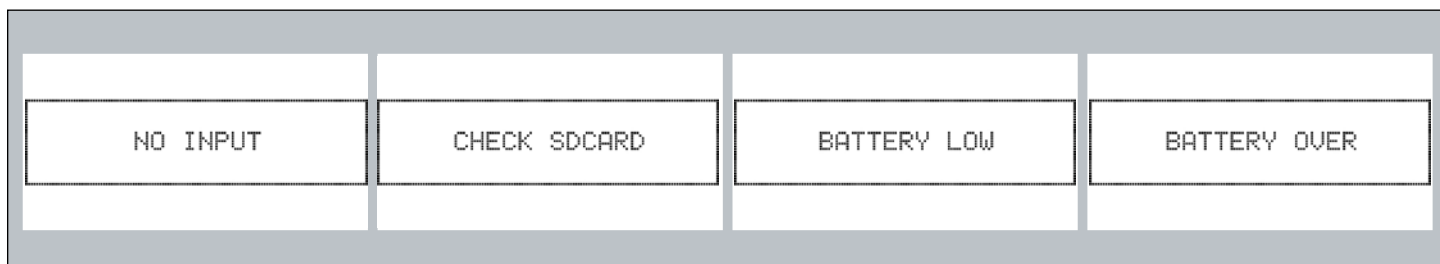

NO INPUT: Alerts when the transmitter has not been used for a predetermined time to save battery.

CHECK SDCARD: Alert to check the proper installation of the SD card.

BATTERY LOW: Batteries need charging.

BATTERY OVER: Signals that the voltage of the battery being used is higher than the voltage setting. Please double check the current voltage specification.

HITEC

Phone: (858) 748 - 8440

E-mail: service@hitecrd.com

Web: www.hitecrd.com

LYNX 4S

4 CHANNEL 2.4GHz SURFACE COMPUTER RADIO SYSTEM