

UNIQUE COCKPIT

Body shell

1/10 RC Short Course Truck
NO.48037

killerbody™

PLANNING INSTRUCTION SHEET

Before beginning assembly, please read these instructions thoroughly!

● Symbols used throughout the instruction manual, comprise:



Cut off shaded portion.



5mm
Drill holes with
the specified diameter.



Pay close attention here!



Must be purchased
separately.



Assemble left and right sides
the same way.



● Before Assembly

Decoration Body

- ▶ In the case of a decoration body, please assemble it according to the contents showed.

When making the window transparent:

- ▶ If you want to make the window transparent with a non decoration body, please assemble it according to the contents showed.

Non Decoration Body

- ▶ In the case of non decoration body, please assemble it according to the contents showed.

When loading LED lights

- ▶ If you want to load LED lights with a non decoration body, please assemble it according to the contents showed.

1 Body shell

Non Decoration Body

When making the window transparent:

When loading LED lights

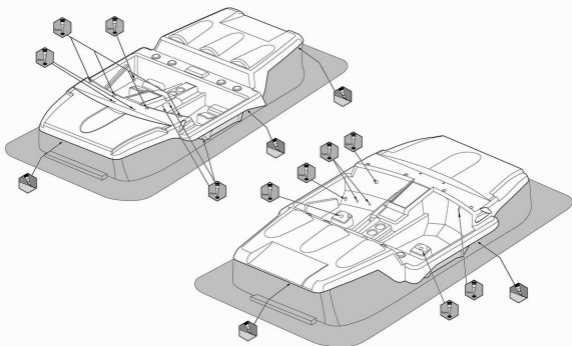

2 Painting

- 1 Before painting, use a neutral detergent to remove any oil residues and dirt.



- 2 Paint the body shell from the inside.



- 3 After painting, remove the protective film from the body shell.

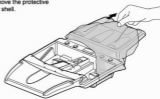

3 Decal

► The decal numbers between brackets are only for the opposite side.





PARTS

PA66 Plastic

BODY ----- X1
 PA66 PLASTIC PARTS ----- X1

PARTS BAG

LED STOPPER ----- X2
 Clip ----- X5
 O-Ring ----- X5
 TAPPING SCREW ----- X4
 DOUBLE-SIDED TAPE ----- X1
 ALUMINUM TAPE ----- X1

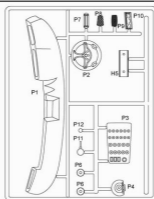

4 Plastic Parts

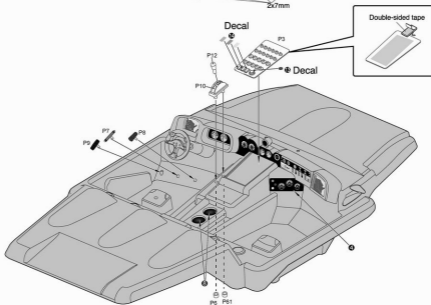
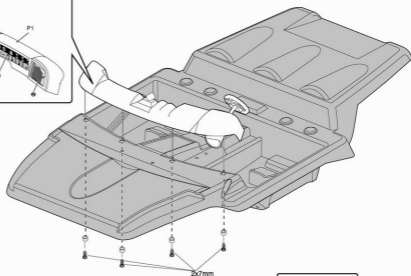
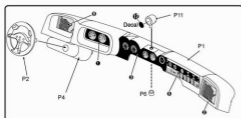

**Seat**

NO.48051

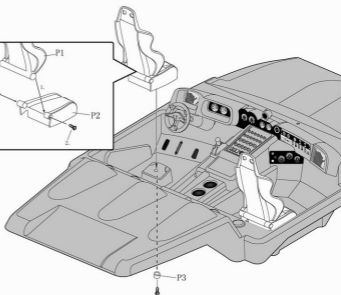
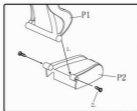
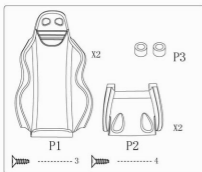
**5 Body****Decoration Body**

When making the window transparent.

Non Decoration Body

When loading LED lights



For safety reasons, always fit the body shell when running your car.

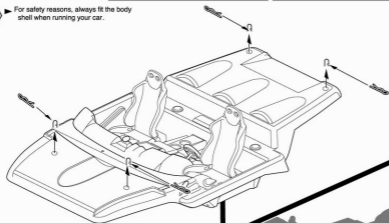

Use the extension body mount (sold separately) if the body mount height is not enough.

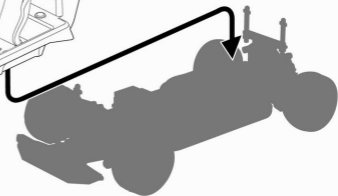
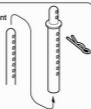
**Option Parts & Accessory**

No.	Part Names	No.	Part Names
48037	Unique Cockpit	48047	Protection Curtain (cloth)
48051	Seat	48048	Protection Net (metal)
48050	Driver		
48053	Seat Belt		
48039	Anti-rolle Bar of Cockpit		
48052	Fire-extinguisher		