



LANGUAGES



INSTRUCTION MANUAL



SPARK XB6

Download the latest colour version of the manual from www.corally.com

Téléchargez la dernière version du manuel sur www.corally.com

Laden Sie die neueste Version des Handbuchs unter www.corally.com herunter

Download de nieuwste versie van de handleiding op www.corally.com



C-00285 Manual - Revised : 2023-11-10

WWW.CORALLY.COM

INTRODUCTION • QUICK START GUIDE



Thank you for purchasing a Team Corally car. This manual describes the instructions for using the model and the electronic components. You will also find some tips on how to maintain your RC model so that you can enjoy it for years to come. You have purchased one of the most efficient models available on the market that has been designed by a team of professionals. You will also benefit from the best after-sales support. All Team Corally models guarantee a high quality of manufacture and performance that guarantees you a high satisfaction of use and services provided by the Team Corally. Always take the time to read the instructions carefully in order to follow all the procedures to use your RC model safely for you and for other people and property in the area. This will allow you to take full advantage of all the performance of your RC model.

Please also check the website www.corally.com/Downloads/ to check if you have the latest version of this instruction manual. (Version: see bottom cover of this manual)

If you have any questions about the model and its components, you can send a message to info@corally.com

We also recommend that you get help from an experienced model maker or your dealer.

You will find all the references of the spare parts on the website www.corally.com

TERM OF USE

The user is responsible for the use of your model. The user assumes all risks associated with the use of the model. This model is not intended for use by children under 14 years of age without the supervision of a responsible adult who is familiar with the dangers of using a RC model. Team Corally / JSP Group Intl bvba, its manufacturers, distributors and resellers cannot control the use and load of the model and therefore cannot be held responsible for any damage to property and damage caused to persons resulting from the use of this product. You must accept these conditions and consider yourself fully responsible for the use of this product. If not, do not use this product.

Due to the continuous development of our products, the exact specifications of the kit may vary. If you have a problem with your new kit, please contact the store where you purchased it, indicating the part number(s).

Team Corally / JSP Group Intl bvba reserves the right to change any specification without notice. All rights reserved.

READ FIRST • QUICK START GUIDE

This owner's manual is designed for use with your vehicle and contains the instructions you will need to operate and maintain your vehicle.

- We know you want to start driving immediately after unpacking, but it is very important that you take the time to read this manual carefully, even if you are an experienced R/C driver.
- Read carefully and follow all instructions in this manual. Failure to comply with the instructions will be considered as abuse and/or negligence which may result in the cancellation of the warranty.
- Your vehicle is designed to operate on uneven terrain. However, dust, sand, water and carpet fibres can get into your car's workspaces and can damage your vehicle if they are not removed quickly. We do not guarantee any warranty on your vehicle against damage caused by external elements such as sand, dirt or water. Users are responsible for the maintenance and safe operation of this vehicle.
- This product is not a toy. It is not suitable for users under 14 years of age, unless they are supervised by adults.
- Never attempt to disassemble electronic components. These have been carefully calibrated at the factory.
- Only improve your car with parts made for your car. If you upgrade performance, replace the entire system (such as the motor, inverter, battery, etc.) so that all components are properly adapted. Any malfunction resulting from a custom modification will void your warranty.
- Before driving your vehicle, please read this manual in its entirety and examine your vehicle and radio control system for any defects.
- For better performance, some adjustments may be necessary.
- This vehicle requires a battery (included in the car or in the packaging). Make sure the vehicle's battery is sufficiently charged before driving, otherwise you may lose control of the vehicle.
- The radio transmitter requires 4 AA batteries (not included)
- Always remove or disconnect the battery from the vehicle to the inverter when not in use.
- Please drive your car in a spacious place. Never drive your car on the street or in traffic. Public places are subject to specific legislation by country, city, municipality, please comply with the legislation for the use of RC models in your region.
- This product is fully assembled in the factory. We accept no liability for damage and/or accidents resulting from custom modifications and/or malfunctions.

SAFETY PRECAUTIONS • QUICK START GUIDE

For your safety, always use wear gloves and goggles when assembling and maintaining your model.

Always take all necessary precautions when handling products (silicone oil, grease, thread lock, cyanolyte glue, fuel) for the operation of the model. (Refer to the manufacturer's instructions)

For your safety, to keep the warranty and obtain the best performance, always use original CORALLY genuine parts.

Contains: LEAD (CAS 7439-92-1) ANTIMONY (CAS 7440-36-0)

WARNING: This product contains a chemical known to the state of California to cause cancer and birth defects or other reproductive harm.

CAUTION: CANCER HAZARD

Contains lead, a listed carcinogen. Lead is harmful if ingested. Wash thoroughly after using.

DO NOT use product while eating, drinking or smoking.

USE PRECAUTIONS • QUICK START GUIDE



Failure to operate your model in a safe and responsible manner may result in injury to yourself, others or damage to property around you.

- Do not use your model on public roads or in areas where you may encounter pedestrians or riders.
- Do not operate in a congested area or in crowds.
- Do not operate in areas where loud noises can disturb others, such as hospitals and residential areas.
- Do not operate your model with obstructed line of sight, at night or near water.
- Your model is radio controlled, it is subject to possible radio interference. Radio interference can cause loss of control of your model. Be careful.
- Take care not to injure yourself while using tools to adjust or upgrade your model.
- Since the model contains small parts, keep out of reach of children while assembling and/or disassembling your model.
- If your model becomes stuck against an object, release the throttle and retrieve it by hand
- Do not continue to apply the throttle when your model is stuck. This may damage the motor and/or ESC/Receiver unit.
- Turn OFF your model and don't use it if it runs erratically. Please do not use your model again until the problem has been solved.
- Keep the wheels of the model off the ground when checking the operation of the radio equipment.
- When learning to operate your model, go to an area that has no obstacles that can damage your model.
- Before and after each use, check all the screws on the model.
- To maintain the best performance, check that all moving parts move freely.

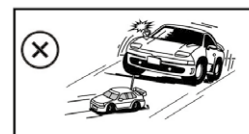

Take all necessary precautions before, during and after using your model. You are responsible for the safe assembly, maintenance and use of your model.

In case of any questions, contact your local reseller or contact Team Corally support for assistance.

LIPO BATTERY SAFETY PRECAUTIONS • QUICK START GUIDE

- Follow and respect the manufacturer's instructions for use
- It is important to check that your ESC is set to LIPO if you are using a LIPO battery. Failure to comply with this instruction will result in increased battery discharge and may cause fire and damage to persons and property.
- When charging or storing LiPo batteries always use LiPo Safety Bag (Flame retardant).
- Always respect the maximum rate and voltage specified by the battery manufacturer.
- Charge the LIPO battery outdoors or in a ventilated area away from flammable objects and surfaces.
- NEVER leave your LiPo battery unattended while charging.
- If the battery swells during charging, stop charging immediately and disconnect the battery from the charger. Leave the battery outside for a few hours and observe. Then recycle the battery according to the instructions of your country/region. Never dispose of a LIPO battery with domestic waste.
- Before recycling your defective battery, it must be neutralized. Take a plastic container, fill it with water and add a lot of salt until the water becomes opaque. Place the LIPO battery in the water and leave for 24 hours. Check with a voltmeter that the voltage is 0.0V. Then recycle the battery according to local regulations.
- Never charge a damaged or inflated battery.
- Never discharge the battery cells below 3.2V.
- Always use the appropriate balancer/charger when charging your LiPo battery pack.
- When the battery is empty, check the temperature of the battery before charging it. If the battery is very hot, wait until it cools before charging it.
- Never charge a very hot battery as this may cause an explosion or fire.
- When the battery is empty, recharge it immediately. Do not store an empty battery, the battery will continue to discharge, it will fall below the minimum voltage and become unusable.

WARRANTY • QUICK START GUIDE



If material defects or manufacturing faults should arise in a product distributed or manufactured by Team Corally / JSP Group Intl bvba, and purchased by a consumer, we Team Corally / JSP Group Intl bvba acknowledge the obligation to correct those faults or defects within the limitations described below. This manufacturer's warranty is in addition to, and does not affect, the legal or contractual rights of the consumer which arise from the purchase of such products. Team Corally / JSP Group Intl bvba guarantees the consumer that its products are free from material, manufacturing, and construction faults, as determined by the general state of knowledge and technology valid at the time of manufacturing. The fault responsible for causing the damage must be proven to have been present in the product at this time. Claims for compensation arising from consequential damage or product liability will not be considered valid unless they fall under peremptory provisions of the law. If material defects or manufacturing faults should arise in a product distributed or manufactured by Team Corally / JSP Group Intl bvba in the European community (EC) and purchased by a consumer, then Team Corally / JSP Group Intl bvba undertakes to correct those defects within the limitations described below. This manufacturer's declaration does not affect the consumer's legal or contractual rights regarding defects arising from the purchase contract between the consumer and the dealer or reseller. **Extend of the Warranty**

If a claim is made under warranty, we take at our discretion to repair or replace the defective goods. We will not consider supplementary claims, especially for reimbursement of costs relating to the defect (e.g. installation / removal costs) and compensation for consequent damages unless they are allowed by statute. This does not affect claims on legal regulations, especially according to the product liability law.

Provisions of the Warranty

The purchaser is required to make the warranty claim in writing, and must enclose original proof of purchase (e.g. invoice, receipt, delivery note) and the appropriate warranty card. He must send the defective goods to our local representatives or directly to Team Corally / JSP Group Intl bvba, Geelseweg 80, 2250 Olen, Belgium at his own risk and cost.

The purchaser should state the material defect or manufacturing fault, or symptoms of the fault, as accurate as possible, so that we can check if our warranty obligation is applicable. The goods are transported from the consumer to us, and from us to the consumer, entirely at the risk and cost of the consumer.

Invalidation of the Warranty

The consumer cannot make a claim under warranty when the fault is affecting the use of the product arising from natural wear, competition use, or improper use (including installation) or external forces. The consumer's adherence to the building and operating instructions relevant to the model, including the installation, operation, use of, and maintenance of, model-related components cannot be supervised by Team Corally / JSP Group Intl bvba. Therefore Team Corally / JSP Group Intl bvba is in no way liable for loss, damage, or costs resulting from improper use, or behaviour in any way connected to the above described provisions. Unless otherwise required by law, Team Corally / JSP Group Intl bvba is in no way whatever liable to provide compensation for damages arising from the improper use of the model (including personal injury, death, damage to buildings, loss of turnover, loss of business, or interruption of business, or any other direct, or indirectly caused, consequential damage).

Duration of Validity

The claim period is 24 months from the date of purchase of the product by the consumer from a dealer in the European Community (EC) counted from the date of purchase. The claim period is 12 months from the date of purchase of the product by the consumer from a dealer outside the European Community (EC) counted from the date of purchase. If a defect arises after the end of the claim period, or if evidence or documents required according to this declaration in order to make the claim valid are not presented until after this period, then the consumer forfeits any rights or claims from this declaration. The guarantee period is not prolonged by the granting of any claims within the framework of this warranty, especially in the case of repair or replacement. The guarantee period also does not restart in such cases.

Warranty Expiration

If we do not acknowledge the validity of a claim based on this declaration within the claim period, all claims based on this declaration will expire after six months from the time of registering the claim; however this cannot occur prior to the end of the claim period.

For any support, contact us at support.corally.com



TECHNICAL SPECIFICATIONS - SPÉCIFICATIONS TECHNIQUES - TECHNISCHE DATEN - TECHNISCHE SPECIFICATIES

Length - Longueur - Länge - Lengte :	495 mm
Width - Largeur - Breite - Breedte :	308 mm
Height - Hauteur - Höhe - Hoogte :	175 mm
Wheelbase - Empattement - Radstand - Wielbasis	327 mm
Weight (no battery) - Poids (sans batterie) - Gewicht (ohne Batterie) - Gewicht (zonder batterij)	3650 g

KIT CONTENT (Depends on the selected colour) - CONTENU DU KIT - KIT-INHALT - INHOUD VAN DE KIT



**2.4GHz 2-Channel
Digital Remote Control System**



**1/8 Scale Brushless Powered
XTREME BUGGY**



Instruction manual
Colour version available on www.corally.com



KURON 825
• 4-Pole
• 2050KV
• 4-6S Sensorless Brushless Motor



TOROX 185 Sensorless ESC
• Waterproof
• 150A Cont. Current
• 2-6S LiPo
• HV BEC
• Programmable



CR-HV 7225
• HV Digital Servo
• Torque 25kg/cm
• Metal Gears

REQUIRED FOR OPERATION (Not included)

NECESSAIRE AU FONCTIONNEMENT (Non inclus) - FÜR DEN BETRIEB ERFORDERLICH (nicht im Lieferumfang enthalten) - NODIG VOOR BEDIENING (Niet inbegrepen)

BATTERIES AND CHARGER - BATTERIES ET CHARGEUR - BATTERIEN UND LADEGERÄT - BATTERIJEN EN LADER

- LiPo Power Pack 4S min. capacity 5000mAh • XT90 connector
- LiPo Power Pack 6S min. capacity 4500mAh • XT90 connector
- 4 pcs AA-Size Dry Cells for the Transmitter -
4 piles taille AA - 4 AA-Batterien - 4 AA-batterijen
- Battery Charger (LiPo) - Chargeur LiPo - LiPo-Ladegerät - LiPo-Lader

FOR MAINTENANCE - Pour l'entretien - Für Wartung - Voor onderhoud

- Hex Drivers 1.5 - 2.0 - 3.0mm -
Tournevis Hexagonal - Inbusschlüssel - Zeskantschroevendraaiers
- Nut Drivers : 5.5mm (M3 Nut) - 7.0mm (M4 Nut)
Tournevis à douille - Mutternschlüssel - Moeren aandrijvers
- Wheel Wrench 24mm
Clé de roue - Radschlüssel - Wielmoersleutel
- Silicone Oil for Differentials ans Shocks
Huile silicone - Silikonöl - Siliconenolie
- Threadlock to secure screws
Frein-filet - Schraubensicherungslack - Threadlock
- Brush and Cloth for cleaning
Brosse et chiffon - Pinsel und Lappen - Penseel en doek



**#C-16250
Team Corally - RC Car Tool Set**
Tool Bag with 16 pcs Tools

*Votre meilleur compagnon pour l'entretien et la réparation de votre voiture - *Ihr bester Begleiter für die Wartung und Reparatur Ihres Autos - *Je beste partner voor het onderhouden en herstellen de auto

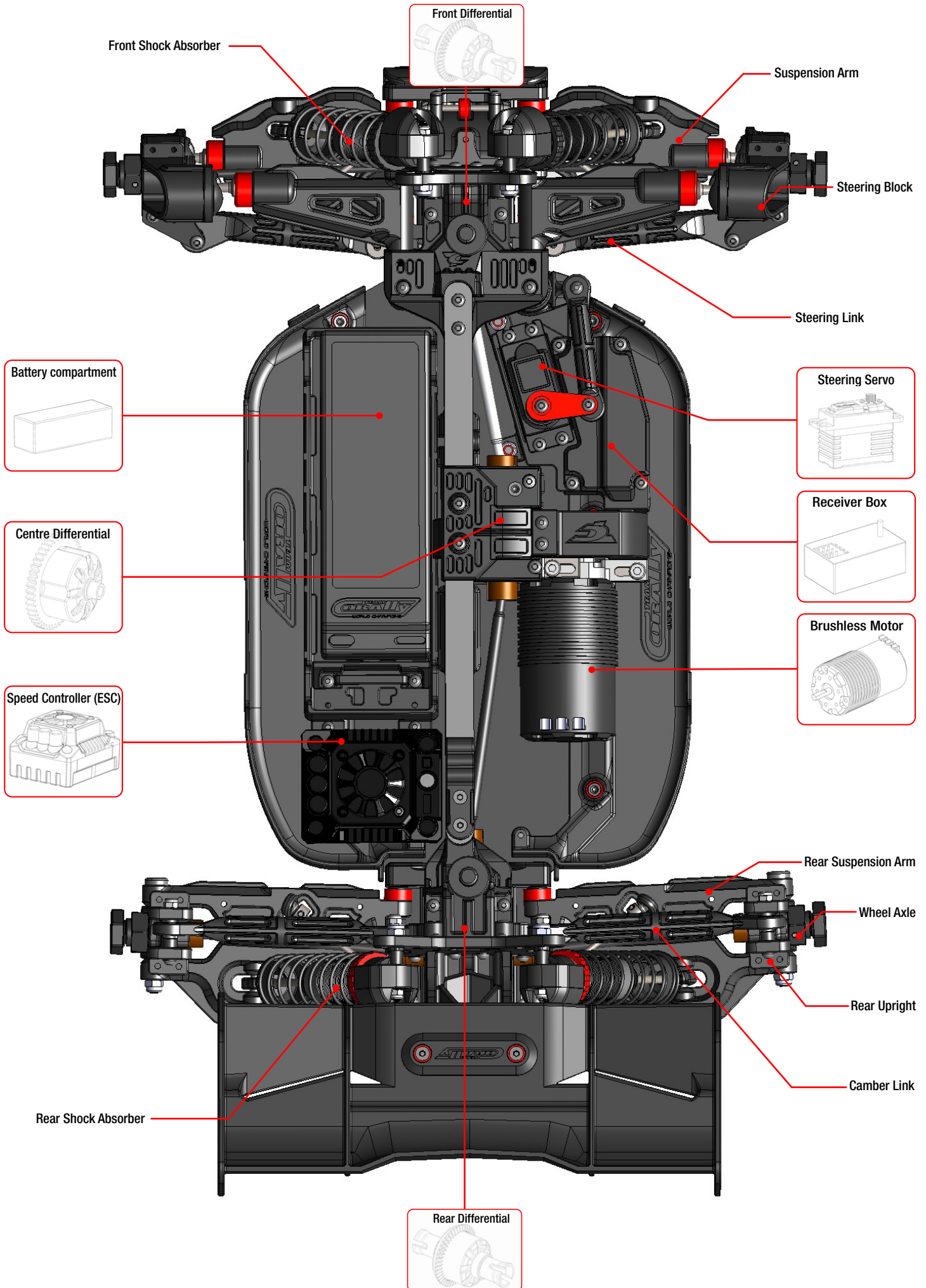



READ THE INSTRUCTIONS



- Lisez les instructions
- Lesen Sie die Anleitung
- Lees de instructies

CHARGE THE BATTERY

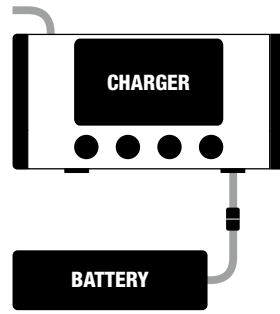

- Chargez la batterie
- Laden Sie den Akku
- De batterij opladen

INSTALL 4x AA BATTERY - 1.5V



- Installez les piles dans l'émetteur
- Setzen Sie die Batterien in den Sender ein
- Plaats de batterijen in de zender

MAKE SURE THAT ALL SCREWS AND NUTS ARE TIGHTENED PROPERLY.

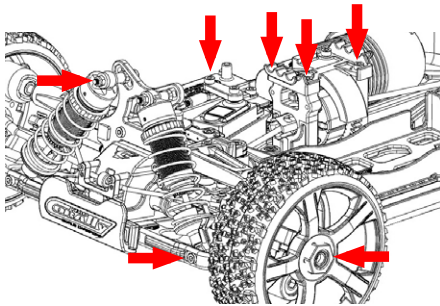

- Vérifiez le serrage des vis et écrous
- Überprüfen Sie die Schrauben und Muttern auf festen Sitz
- Controleer de vastheid van de schroeven en moeren

INSTALL THE FULLY CHARGED BATTERY

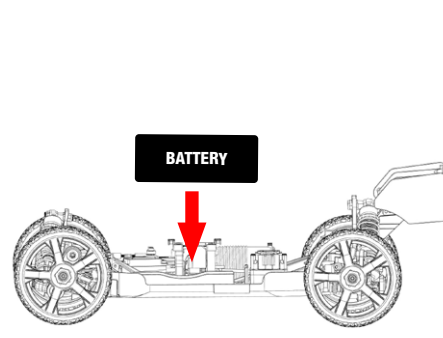

- Installez la batterie chargée
- Setzen Sie den geladenen Akku ein
- Installeer de opgeladen batterij

TURN ON THE TRANSMITTER (Always First)



- Allumez l'émetteur (Toujours en premier)
- Schalten Sie den Sender ein (Immer zuerst)
- Zet de zender aan (altijd eerst)

CONNECT THE BATTERY TO THE ESC SWITCH ON THE ESC

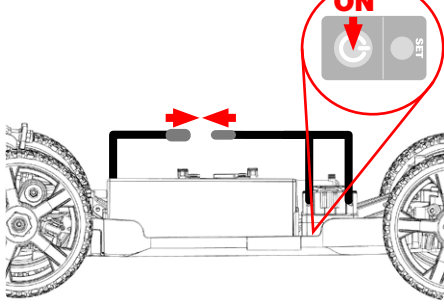

- Connectez la batterie au variateur et allumez-le
- Schließen Sie den Akku an den Regler an und schalten Sie ihn ein
- Sluit de accu aan op de regelaar en schakel deze in

CHECK THE FUNCTIONS

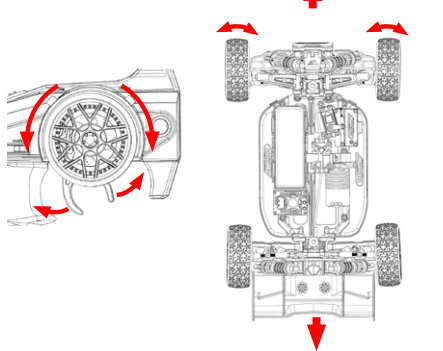

- Contrôlez les fonctions
- Kontrollieren Sie die Funktionen
- Controle van de functies

CHECK THE RADIO SYSTEM RANGE

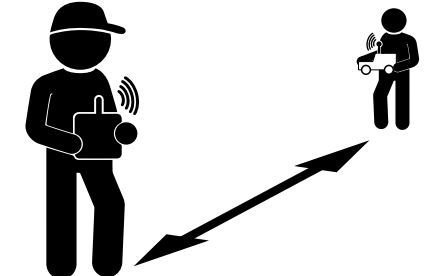

Move away from the max. distance you will drive the vehicle. Check that the vehicle responds properly to the controls. If not, reduce the distance or change the driving location.

- Contrôlez la portée de l'émetteur
- Überprüfen Sie die Reichweite des Senders
- Controleer het bereik van de zender

DRIVE SLOWLY TO BEGIN

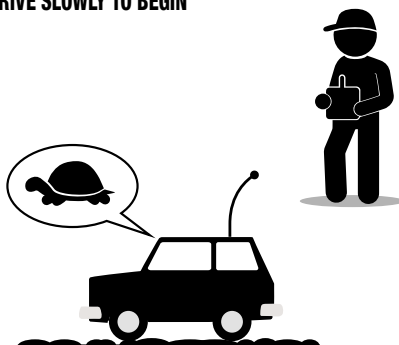

- Roulez lentement pour débuter
- Fahren Sie zu Beginn langsam
- Langzaam rijden om te beginnen

WHEN FINISHING

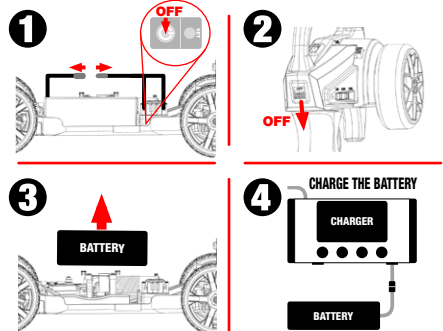

- Après, débranchez la batterie et rechargez-la
- Trennen Sie danach den Akku ab und laden Sie ihn auf
- Maak daarna de accu los en laad deze op

CLEAN AND MAINTAIN YOUR VEHICLE

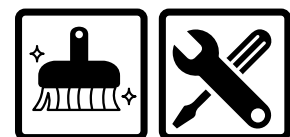

- Nettoyez et entretenez votre voiture !
- Reinigen und pflegen Sie Ihr Auto!
- Reinigen en onderhoud uw auto!



GEAR RATIO

SPEED GEAR CHART - Tableau de vitesse - Drehzahlgangdiagramm - Versnellingstabel

With Spur Gear 46T - Gear Ratio 3.31

Avec couronne 46D - Rapport de démultiplication 3.31 - Mit Hauptzahnrad 46Z - Gear Ratio 3.31 - Met tandwiel 46T - Gear Ratio 3.31

	Km/h	Mph	Km/h	Mph	Km/h	Mph	Km/h	Mph	Km/h	Mph	Km/h	Mph	Km/h	Mph	Km/h	Mph
Gear	11T Pinion		12T Pinion		13T Pinion		14T Pinion		15T Pinion		16T Pinion		17T Pinion		18T Pinion	
46T	13,83		12,68		11,71		10,87		10,14		9,51		8,95		8,45	
4S	58	36	63	39	69	43	74	46	79	49	84	52	90	56	95	59

OK

Factory fitted

Usable but not recommended

Not recommended, at your own risk



Note: The speed indicated in the table is a theoretical speed for information purposes. The real speed varies according to the type of terrain, electronic equipment, atmospheric conditions and other driving parameters.

Note: La vitesse indiquée dans le tableau est une vitesse théorique à titre indicatif. La vitesse réelle varie en fonction du type de terrain, de l'équipement électronique, des conditions atmosphériques et d'autres paramètres de conduite.

Bemerkung: Die in der Tabelle angegebene Geschwindigkeit ist eine theoretische Geschwindigkeit, die nur als Referenz dient. Die tatsächliche Geschwindigkeit hängt von der Art des Geländes, der elektronischen Ausrüstung, den Wetterbedingungen und anderen Fahrparametern ab.

Nota: De in de tabel aangegeven snelheid is een theoretische snelheid, uitsluitend ter referentie. De werkelijke snelheid varieert afhankelijk van het soort terrein, de elektronische apparatuur, de weersomstandigheden en andere rijparameters.

MOTOR PINION MOD1.0 - PIGNON MOTEUR MOD1.0 - MOTORRITZEL MOD1.0 - MOTOR PINION MOD1.0

- You can choose a different pinion size to change the speed or acceleration. The car is equipped with a 13-tooth pinion from the factory, which is the best ratio of power to speed and battery life. Adapt the pinion to the type of terrain (off-road = small pinion, speed = large pinion). If the motor gets too hot or the controller shuts down (safety), the motor makes too much effort, reduce the pinion size.

- Vous pouvez choisir un pignon de taille différente pour modifier la vitesse ou l'accélération. La voiture est équipée du pignon 13 dents en usine ce qui est le meilleur rapport puissance/vitesse et autonomie. Adaptez le pignon en fonction du type de terrain (tout-terrain = petit pignon, vitesse = grand pignon). Si le moteur chauffe trop ou le variateur se coupe (sécurité), le moteur fait trop d'effort, réduisez la taille du pignon.

- Sie können ein Ritzel unterschiedlicher Größe wählen, um die Geschwindigkeit oder die Beschleunigung zu verändern. Das Auto ist ab Werk mit einem Ritzel mit 13 Zähnen ausgestattet, was das beste Verhältnis von Leistung/Geschwindigkeit und Reichweite darstellt. Passen Sie das Ritzel an den jeweiligen Geländetyp an (Gelände = kleines Ritzel, Geschwindigkeit = großes Ritzel). Wenn der Motor zu heiß wird oder der Regler sich abschaltet (Sicherheit), der Motor zu viel Kraft aufbringt, reduzieren Sie die Größe des Ritzels.

- U kunt een andere tandwielmaat kiezen om de snelheid of versnelling te veranderen. De auto is in de fabriek uitgerust met een 13-tands tandwiel, de beste verhouding tussen vermogen, snelheid en bereik. Pas het tandwiel aan het soort terrein aan (off-road = klein tandwiel, snelheid = groot tandwiel). Als de motor te heet wordt of de regelaar uitschakelt (veiligheid), levert de motor te veel inspanning, verklein dan het tandwiel.

M1.0 PINION - Hardened Steel - for 5mm diameter shaft



C-72711 - Pinion 11 Teeth

C-72712 - Pinion 12 Teeth

C-72713 - Pinion 13 Teeth

C-72714 - Pinion 14 Teeth

C-72715 - Pinion 15 Teeth

C-72716 - Pinion 16 Teeth

C-72717 - Pinion 17 Teeth

• High-performance pinions gear, manufactured from special steel for toughness and durability with precise tolerances and assures unparalleled concentricity and vibration-free operation. Each pinion is marked with the tooth number for easy and quick identification. Fits all cars with MOD1 gears (1/8 Scale)

• Pignons Haute Performance, fabriqué en acier spécial avec des tolérances précises pour garantir solidité, longévité et concentricité et fonctionnement sans vibrations. Chaque pignon est marqué du nombre de dents pour une identification facile et rapide. Convient à toutes les voitures avec une transmission MOD1 (Echelle 1/8)

• Hochleistungsritzel, hergestellt aus Spezialstahl mit präzisen Toleranzen, um Festigkeit, Langlebigkeit und Rundlauf sowie einen vibrationsfreien Betrieb zu gewährleisten. Jedes Ritzel ist mit der Anzahl der Zähne gekennzeichnet, damit es schnell und einfach identifiziert werden kann. Passend für alle Fahrzeuge mit MOD1-Getriebe (Maßstab 1/8)

• Tandwielen met hoge performance, geproduceerd van speciaal staal met nauwkeurige toleranties om sterkte, duurzaamheid, concentriciteit en trillingsvrije werking te garanderen. Elk tandwiel is gemarkeerd met het aantal tanden voor snelle en eenvoudige identificatie. Past op alle auto's met MOD1-transmissie (schaal 1/8)



GEAR MESH ADJUSTMENT - AJUSTEMENT DE L'ENGRENAGE - GETRIEBEVERSTELLUNG - TANDWIELAFSTELLING

- If the gear mesh is not correct, you wear out the spur gear prematurely, the transmission will make noise, give unnecessary load on the motor (higher consumption, heating of the transmission).
- Si l'espace entre le pignon et la couronne n'est pas correct, la couronne dentée s'use prématurément, la transmission fait du bruit et le moteur est inutilement sollicité (consommation plus élevée, échauffement de la transmission).
- Wenn der Abstand zwischen Ritzel und Tellerrad nicht stimmt, verschleißt das Zahnrad vorzeitig, das Getriebe macht Geräusche und der Motor wird unnötig belastet (höherer Verbrauch, Erwärmung des Getriebes).
- Als de afstand tussen het tandwiel en de recht tandwiel niet correct is, slijt de recht tandwiel voortijdig, maakt de transmissie lawaai en wordt de motor onnodig belast (hoger verbruik, verhitting van de transmissie).

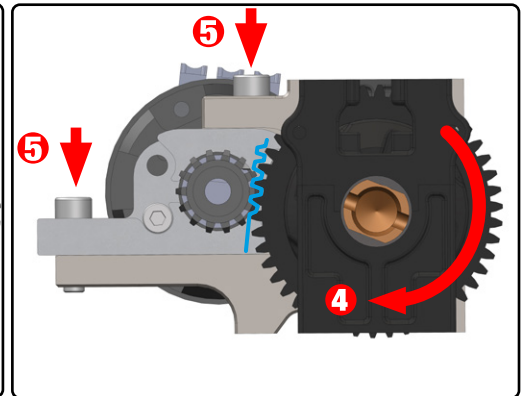
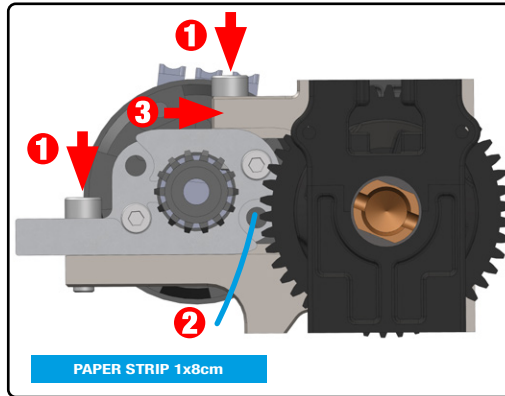
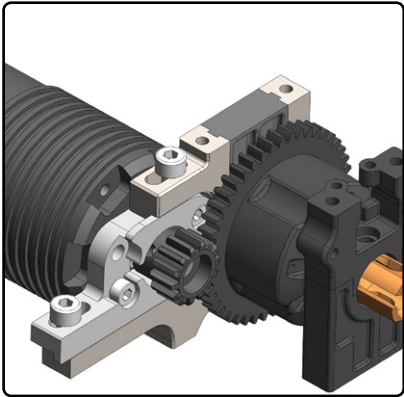

1. Loosen the screws.

Desserrez les vis.
Lösen Sie die Schrauben.
Draai de schroeven los.

2. Insert the paper strip.

Insérez la bande de papier.
Legen Sie den Papierstreifen ein.
Plaats de papierstrook.

3. Push the motor against the spur gear.

Poussez le moteur contre la couronne dentée.
Schieben Sie den Motor gegen das Zahnrad.
Duw de motor tegen het recht tandwiel.

4. Turn the spur gear to run the paper through the teeth.

Stop when the paper is in the middle.

Make sure that the motor pinion is against the spur gear.

Tournez la couronne dentée pour faire passer le papier entre les dents.
Arrêtez lorsque le papier est au milieu.
Assurez-vous que le pignon du moteur est contre la couronne dentée.

Drehen Sie das Hauptzahnrad, um das Papier durch die Zähne zu führen.

Halten Sie an, wenn sich das Papier in der Mitte befindet.

Achten Sie darauf, dass das Motorritzel am Hauptzahnrad anliegt.

Draai aan het rechte tandwiel om het papier door de tanden te laten lopen.

Stop wanneer het papier in het midden is.

Zorg ervoor dat het motortandwiel tegen het rechte tandwiel staat.

5. Maintain and tighten the fixing screws.

Maintenez et serrez les vis de fixation.

Halten Sie die Befestigungsschrauben fest und ziehen Sie sie an.

De bevestigingsschroeven aanhouden en vastdraaien.



SHOCK ABSORBER MAINTENANCE - ENTRETIEN DES AMORTISSEURS - STOSSDÄMPFERWARTUNG - ONDERHOUD SCHOKDEMPERS

- It may be necessary to replace the silicone oil in the shock absorbers every 40 runs (depends on how you drive and the type of terrain you drive on).
- Il peut être nécessaire de remplacer l'huile silicone des amortisseurs toutes les 40 courses (cela dépend de votre conduite et du type de terrain sur lequel vous roulez).
- Es kann notwendig sein, das Silikonöl in den Stoßdämpfern alle 40 Fahrten zu wechseln (abhängig von Ihrer Fahrweise und dem Gelände, auf dem Sie fahren).
- Het kan nodig zijn de siliconenolie in de schokdempers om de 40 ritten te vervangen (afhankelijk van uw rijstijl en het soort terrein waarop u rijdt).

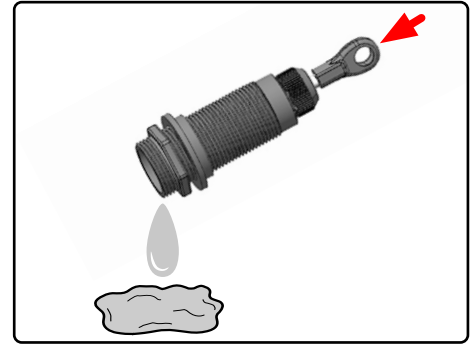
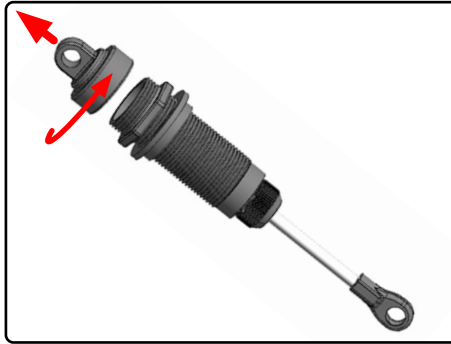
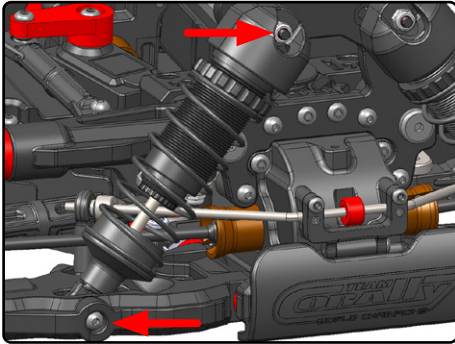

ALWAYS USE SILICONE OIL, NEVER USE ANY OTHER TYPES OF OIL • Toujours utiliser de l'huile de silicone pure, jamais d'autres types d'huile • Verwenden Sie immer Silikonöl, niemals andere Öle • Gebruik altijd siliconenolie, gebruik nooit andere soorten olie

FILL	MOVE UP	WAIT	TIGHTEN 50%	MOVE UP	TIGHTEN FULLY
<p>2 </p>					
<ul style="list-style-type: none"> • Fill the shock with silicone oil. • Remplissez l'amortisseur avec de l'huile de silicone. • Füllen Sie den Dämpfer mit Silikonöl. • Vul de schokdemper met siliconenolie. 	<ul style="list-style-type: none"> • Move the piston up&down (3-4x) to release the air bubbles in the silicone oil. • Déplacez le piston de haut en bas (3-4x) pour libérer les bulles d'air. • Bewegen Sie den Kolben nach oben&unten (3-4x), um die Luftblasen abzulassen. • Beweeg de zuiger op en neer (3-4x) om de luchtbelleten te laten ontsnappen. 	<ul style="list-style-type: none"> • Pull the Shock shaft down and wait until the bubbles rise to the surface. • Tirez la tige d'amortisseur vers le bas et attendez que les bulles remontent à la surface. • Ziehen Sie die Schockwelle nach unten und warten Sie, bis die Blasen an die Oberfläche steigen. • Trek de Schokas naar beneden en wacht tot de luchtbelleten naar de oppervlakte stijgen. 	<ul style="list-style-type: none"> • Screw in the shock absorber cap at 50%. • Vissez le bouchon d'amortisseur à 50% • Schrauben Sie die Stoßdämpferkappe zu 50 % ein. • Schroef de dop van de schokdemper op 50%. 	<ul style="list-style-type: none"> • Gently move the piston in upper position, the oil excess will flow out. • Déplacez doucement le piston en position haute, l'excédent d'huile s'écoulera. • Bewegen Sie den Kolben vorsichtig in die obere Position, das überschüssige Öl fließt dann heraus. • Beweeg de piston langzaam in de bovenste positie, de overtollige olie zal eruit stromen. 	<ul style="list-style-type: none"> • Now tighten the cap fully but not too much otherwise the membrane will be deformed. • Maintenant, serrez le bouchon à fond, mais pas trop, sinon la membrane sera déformée. • Ziehen Sie nun die Kappe vollständig, aber nicht zu fest an, da sonst die Membran verformt wird. • Draai nu de dop helemaal vast, maar niet te vast, anders wordt het membraan vervormd.

	FRONT		REAR		SHOCK PISTON
	SILICONE OIL	SPRING TENSION	SILICONE OIL	SPRING TENSION	
TRACK USE	450CPS	4mm	400CPS	0mm	4 Holes
OFF-ROAD	600CPS	4mm	500CPS	0mm	4 Holes
FACTORY	500CPS		500CPS		4 Holes

www.corally.com/Chemicals/Silicone-Oils/



SHOCK ABSORBER - AMORTISSEUR - STOSSDÄMPFER - SCHOKDEMPER

- Do not overtighten the Shock Cap to prevent deformation of the silicone Shock Bladder.
- Ne serrez pas trop le capuchon de l'amortisseur pour éviter la déformation de la membrane en silicone.
- Ziehen Sie die Dämpferabdeckung nicht zu fest an, um eine Verformung der Silikonmembran zu vermeiden.
- Draai de schokkap niet te strak aan om vervorming van het siliconenmembraan te voorkomen.

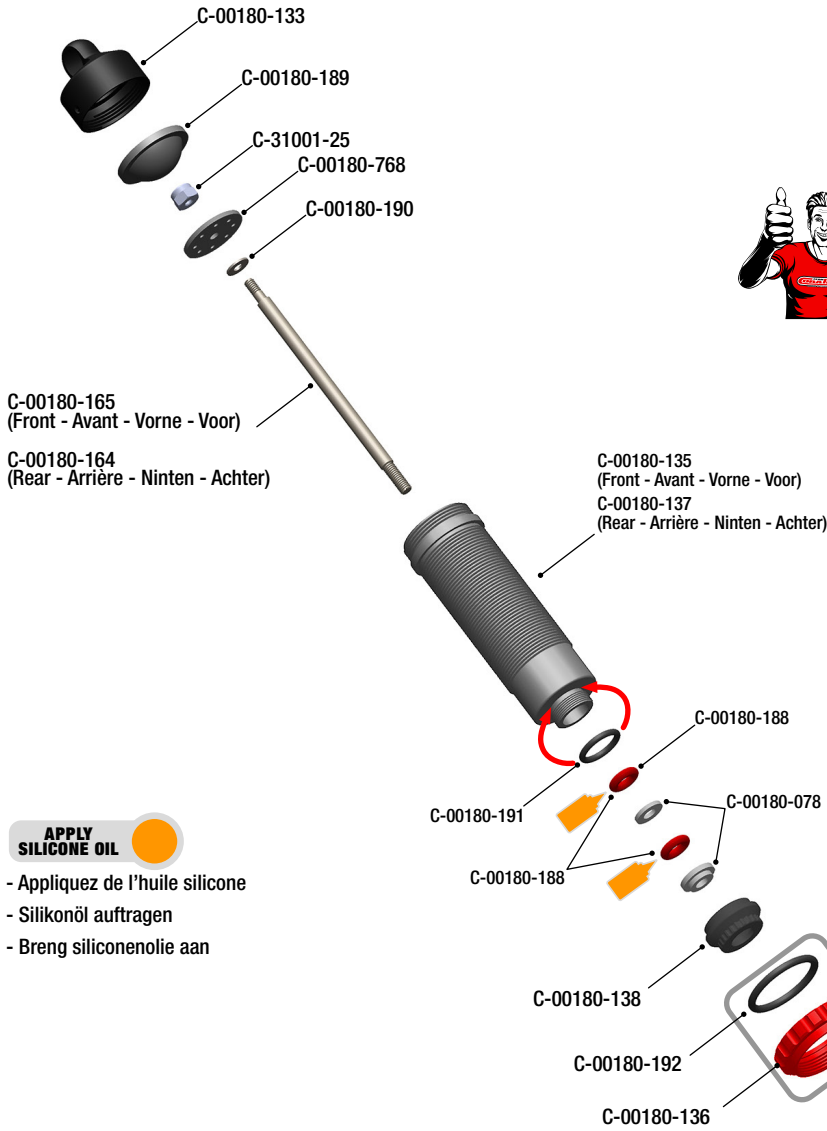

APPLY SILICONE OIL

- Appliquez de l'huile silicone
- Silikonöl auftragen
- Breng siliconenolie aan



C-00180-768 Shock Piston (8pcs)
 Shock Piston - **6 Holes 1.4**
 Shock Piston - **8 Holes 1.2** (Factory installed)



- Place all small parts on a screwdriver (Ø3mm) and push them into the shock body. All parts will be properly aligned.
- Placez toutes les petites pièces sur un tournevis (Ø3mm) et poussez-les dans le corps de l'amortisseur. Toutes les pièces seront correctement alignées.
- Setzen Sie alle Kleinteile auf einen Schraubendreher (Ø3mm) und drücken Sie sie in den Dämpferkörper. Alle Teile werden richtig ausgerichtet.
- Plaats alle kleine onderdelen op een schroevendraaier (Ø3mm) en duw ze in de behuizing van de schokdemper. Alle onderdelen zullen goed uitgelijnd zijn.

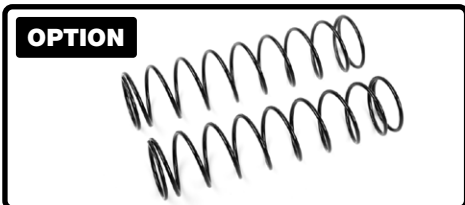

REF		TYPE	POSITION	THICKNESS	LENGTH
C-00180-626	Shock Spring	SOFT	FRONT	1.4mm	L: 75-77mm
C-00180-627	Shock Spring	MEDIUM	FRONT	1.6mm	L: 75-77mm
C-00180-628	Shock Spring	HARD	FRONT	1.8mm	L: 75-77mm
C-00180-289	Shock Spring	SOFT	REAR	1.4mm	L: 84-86mm
C-00180-290	Shock Spring	MEDIUM	REAR	1.6mm	L: 84-86mm
C-00180-291	Shock Spring	HARD	REAR	1.8mm	L: 84-86mm

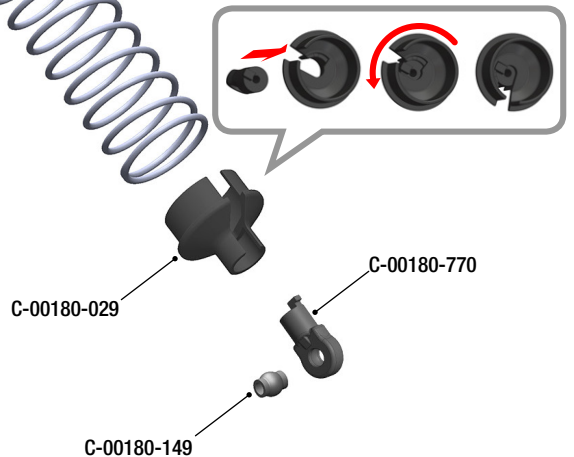



DIFFERENTIAL MAINTENANCE - ENTRETIEN DU DIFFÉRENTIEL - DIFFERENZIALWARTUNG - DIFFERENTIEEL ONDERHOUD

- It may be necessary to replace the silicone oil every 50 runs (depends on how you drive and the type of terrain you drive on). To dismount and maintain the differentials, follow the steps on these pages. To reassemble the differentials, repeat the steps in reverse.
- Il peut être nécessaire de remplacer l'huile silicone toutes les 50 courses (cela dépend de votre conduite et du type de terrain sur lequel vous roulez). Pour démonter et entretenir les différentiels, suivez les étapes sur ces pages. Pour remonter les différentiels, répétez les étapes en sens inverse.
- Es kann notwendig sein, das Silikonöl alle 50 Fahrten zu wechseln (abhängig von Ihrer Fahrweise und dem Gelände, auf dem Sie fahren). Um die Differentialle zu zerlegen und zu warten, befolgen Sie die Schritte auf diesen Seiten. Um die Differenziale wieder zusammensetzen, wiederholen Sie die Schritte in umgekehrter Reihenfolge.
- Het kan nodig zijn de siliconenolie om de 50 ritten te vervangen (afhankelijk van uw rijstijl en het soort terrein waarop u rijdt). Volg de stappen op deze pagina's om de differentiëlen te verwijderen en te onderhouden. Om de differentiëlen weer in elkaar te zetten, herhaalt u de stappen in omgekeerde volgorde.

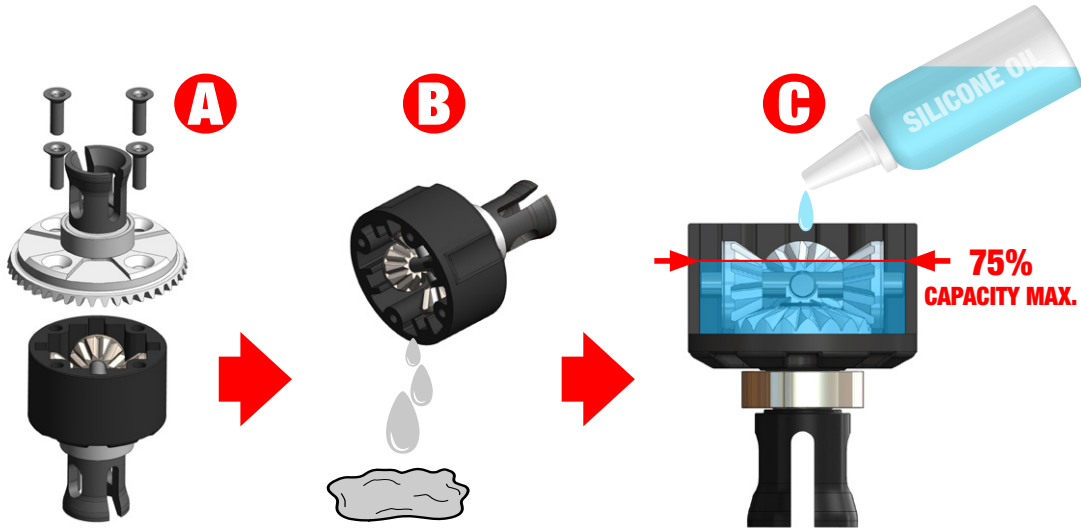

	FRONT DIFF	CENTRE DIFF	REAR DIFF
TRACK USE	7500CPS	15.000CPS	5000CPS
OFF-ROAD	10.000CPS	30.000CPS	7500CPS
FACTORY	20.000CPS	50.000CPS	10.000CPS

- Use the correct grade of silicone oil according to the operation. Use only Silicone Oil, never use any other types of oil.
- Utiliser la bonne qualité d'huile de silicone en fonction de l'opération. N'utilisez que de l'huile de silicone, jamais d'autres types d'huile.
- Verwenden Sie die richtige Silikonölsorte für den jeweiligen Einsatz. Verwenden Sie nur Silikonöl, niemals andere Ölsorten.
- Gebruik de juiste soort siliconenolie, afhankelijk van de werking. Gebruik alleen siliconenolie, gebruik nooit andere soorten olie.

FRONT DIFFERENTIAL - DIFFÉRENTIEL AVANT - VORDERACHSDIFFERENTIAL - VOORSTE DIFFERENTIEEL

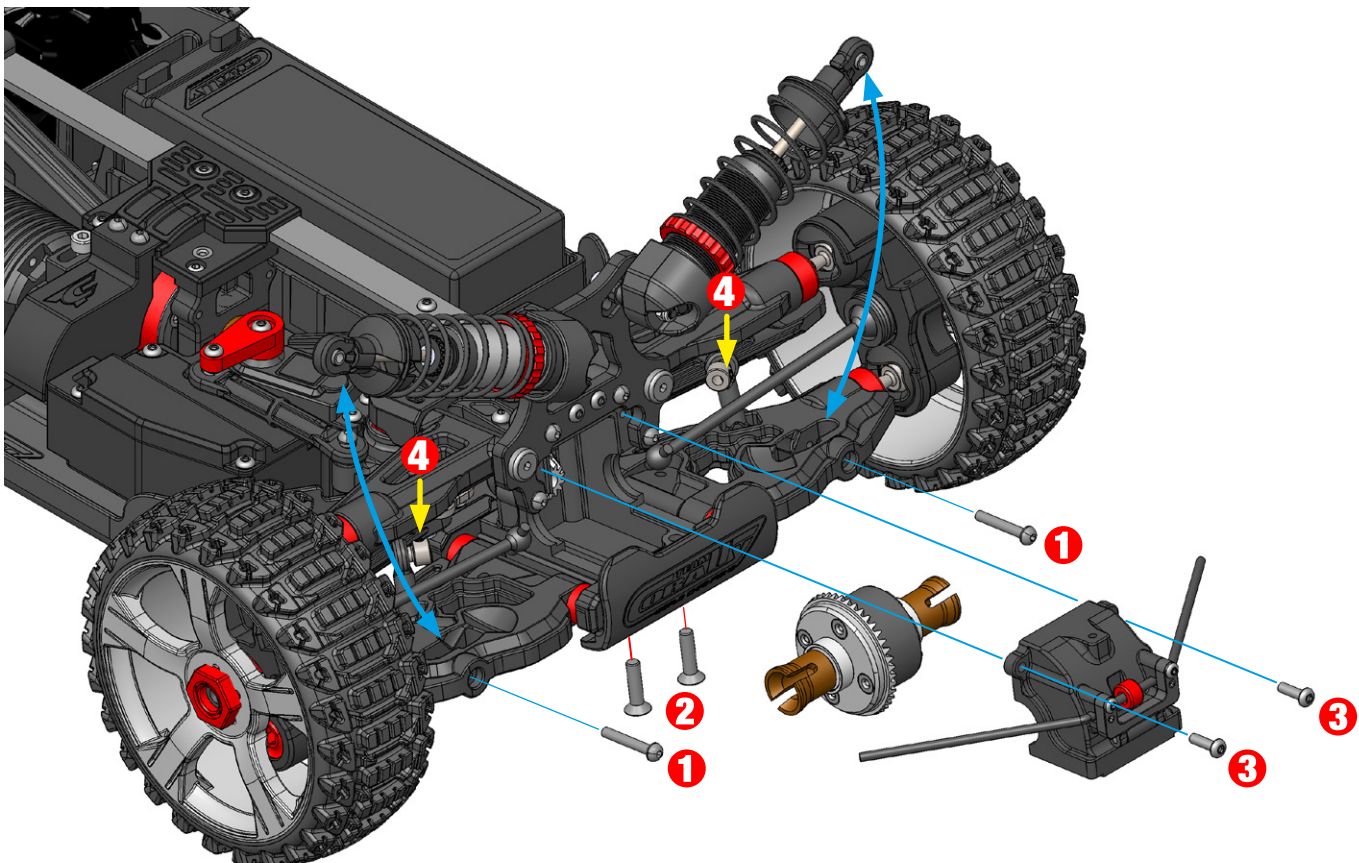



REAR DIFFERENTIAL - DIFFÉRENTIEL ARRIÈRE - HINTERES DIFFERENTIAL - ACHTERSTE DIFFERENTIEEL

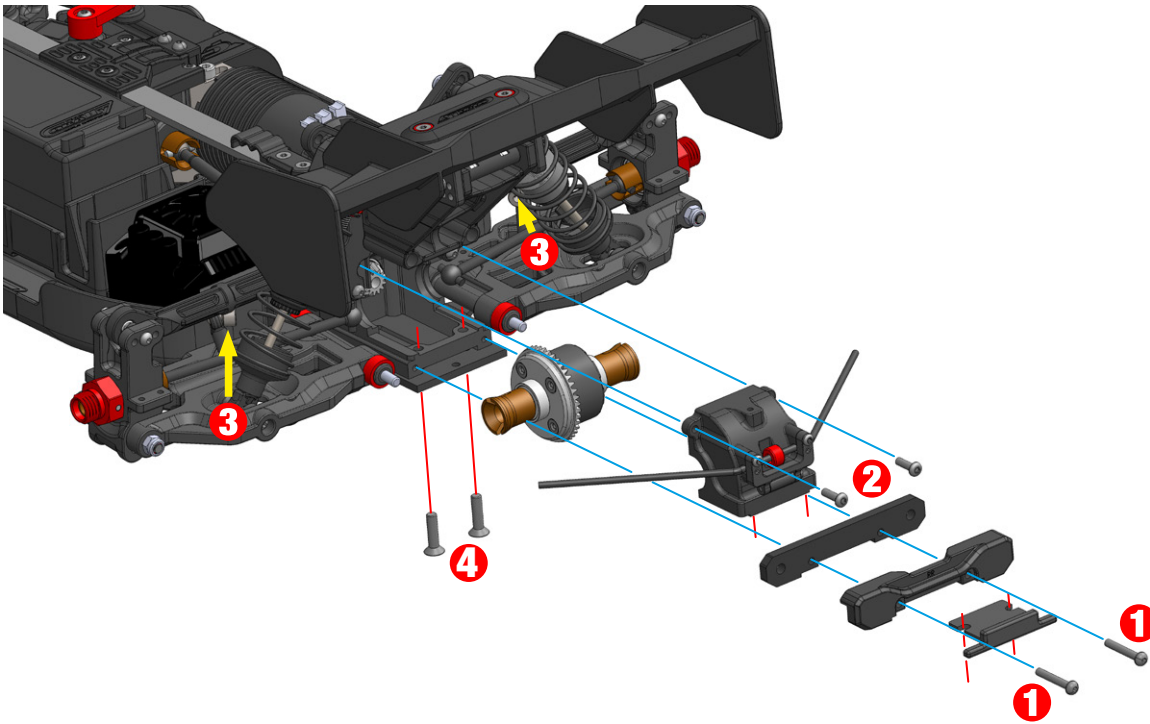

CENTRE DIFFERENTIAL - DIFFÉRENTIEL CENTRAL - MITTELDIFFERENTIAL - MIDDELSTE DIFFERENTIEELENTIEEL

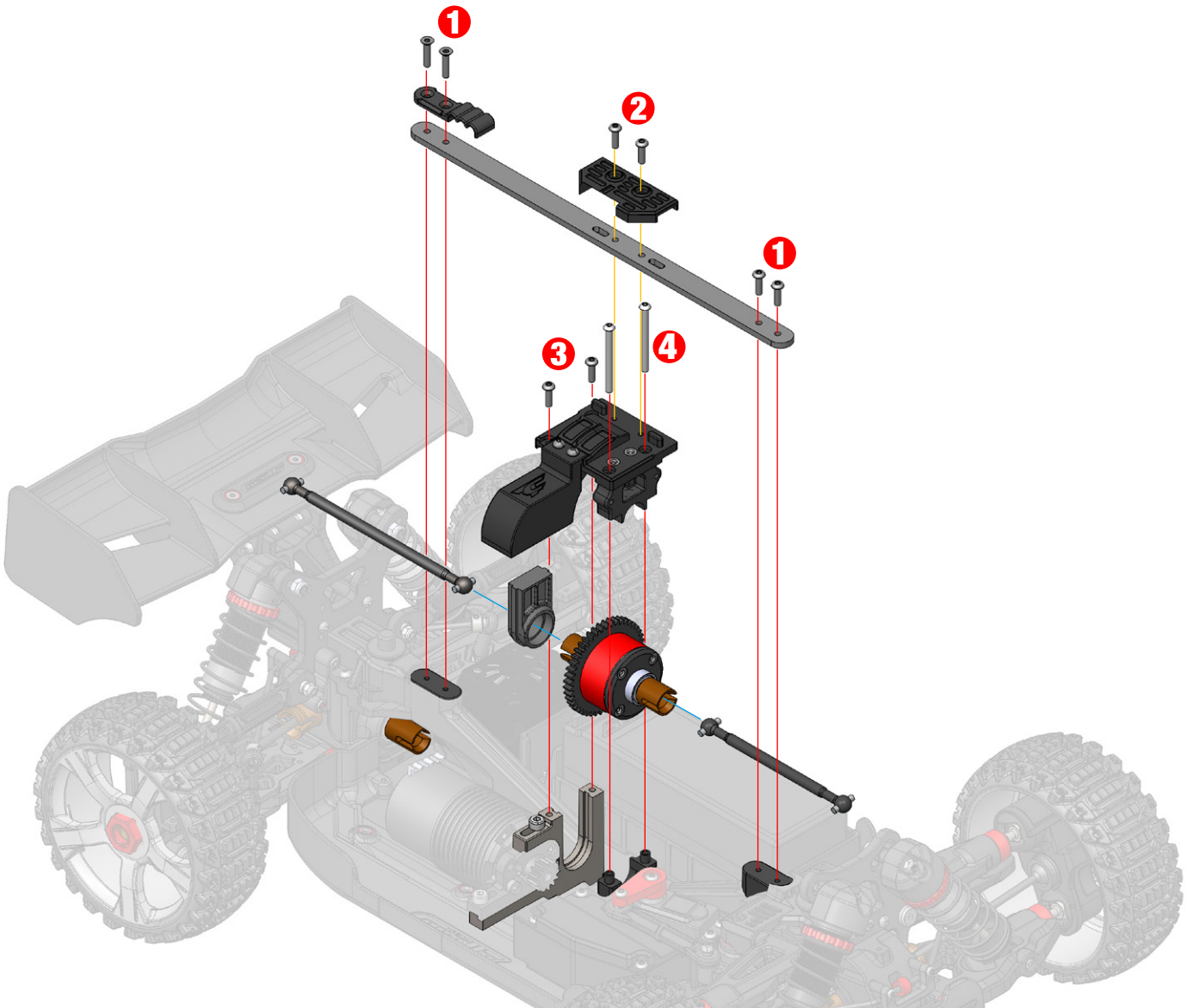

FRONT & REAR DIFFERENTIAL - DIFFÉRENTIEL AV & AR - DIFFERENTIAL VORNE UND HINTEN - VOOR & ACHTER DIFFERENTIEEL

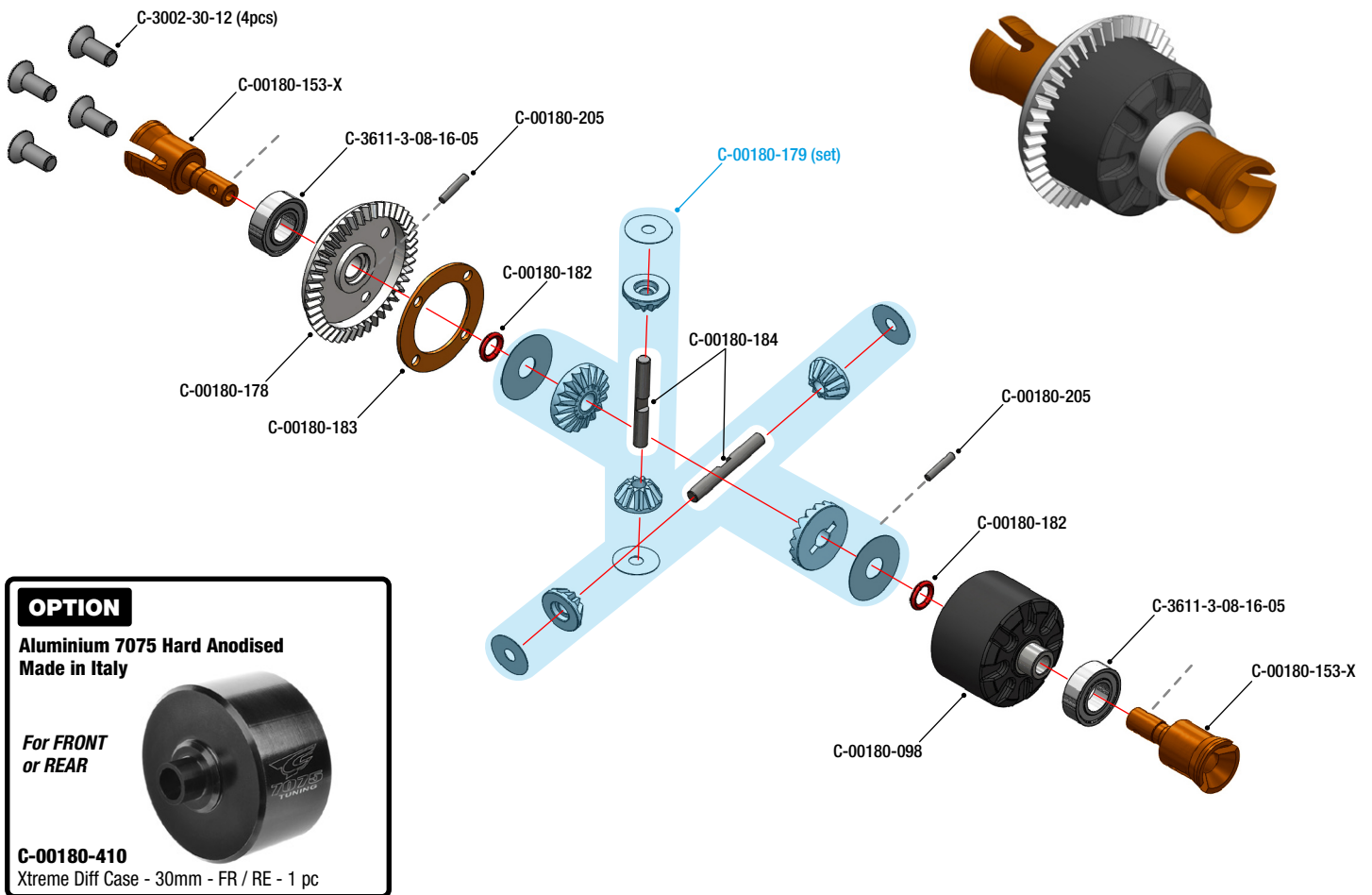

CENTRE DIFFERENTIAL - DIFFÉRENTIEL CENTRAL - ZENTRALDIFFERENTIAL - MIDDENDIFFERENTIEEL

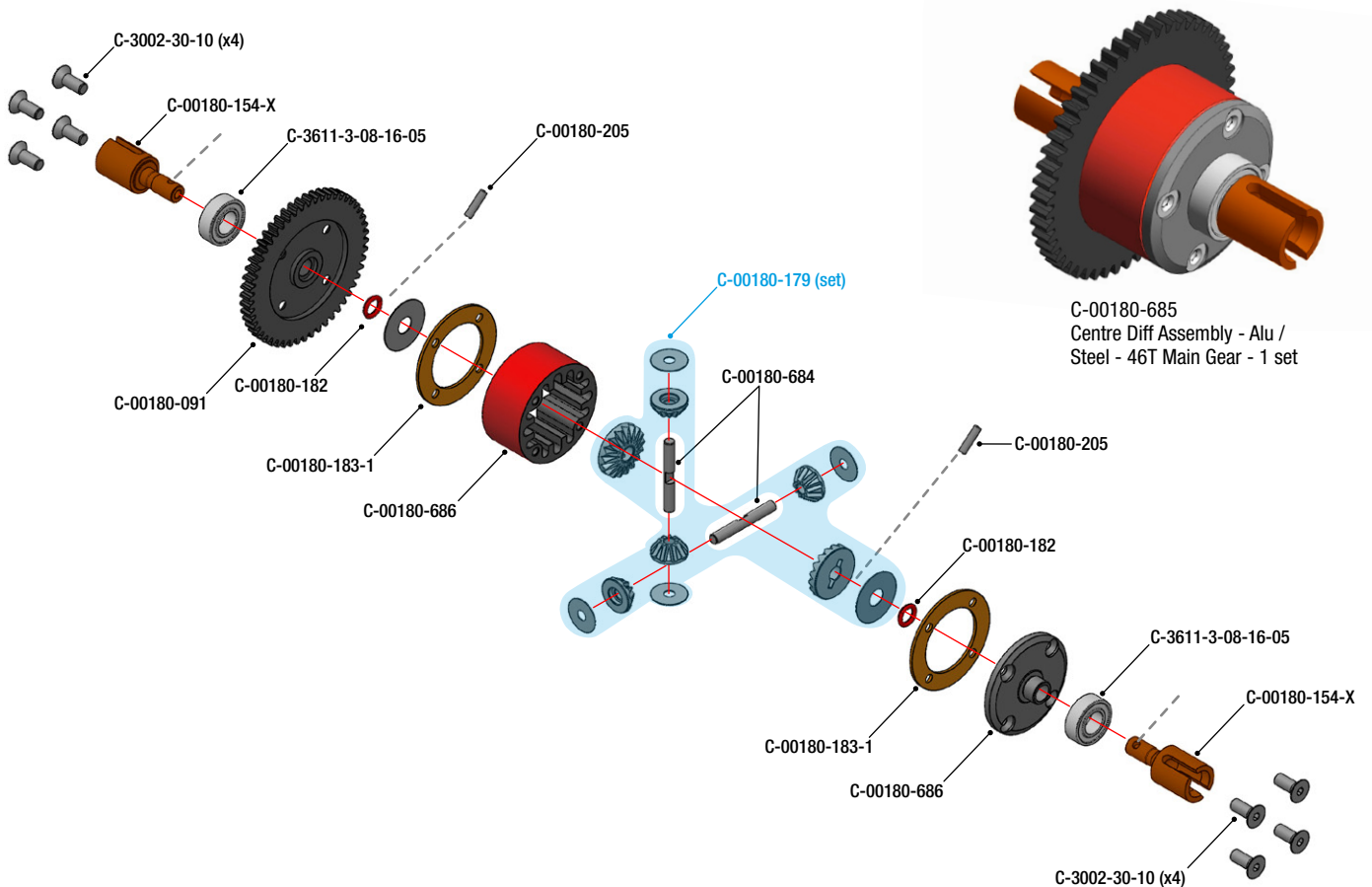

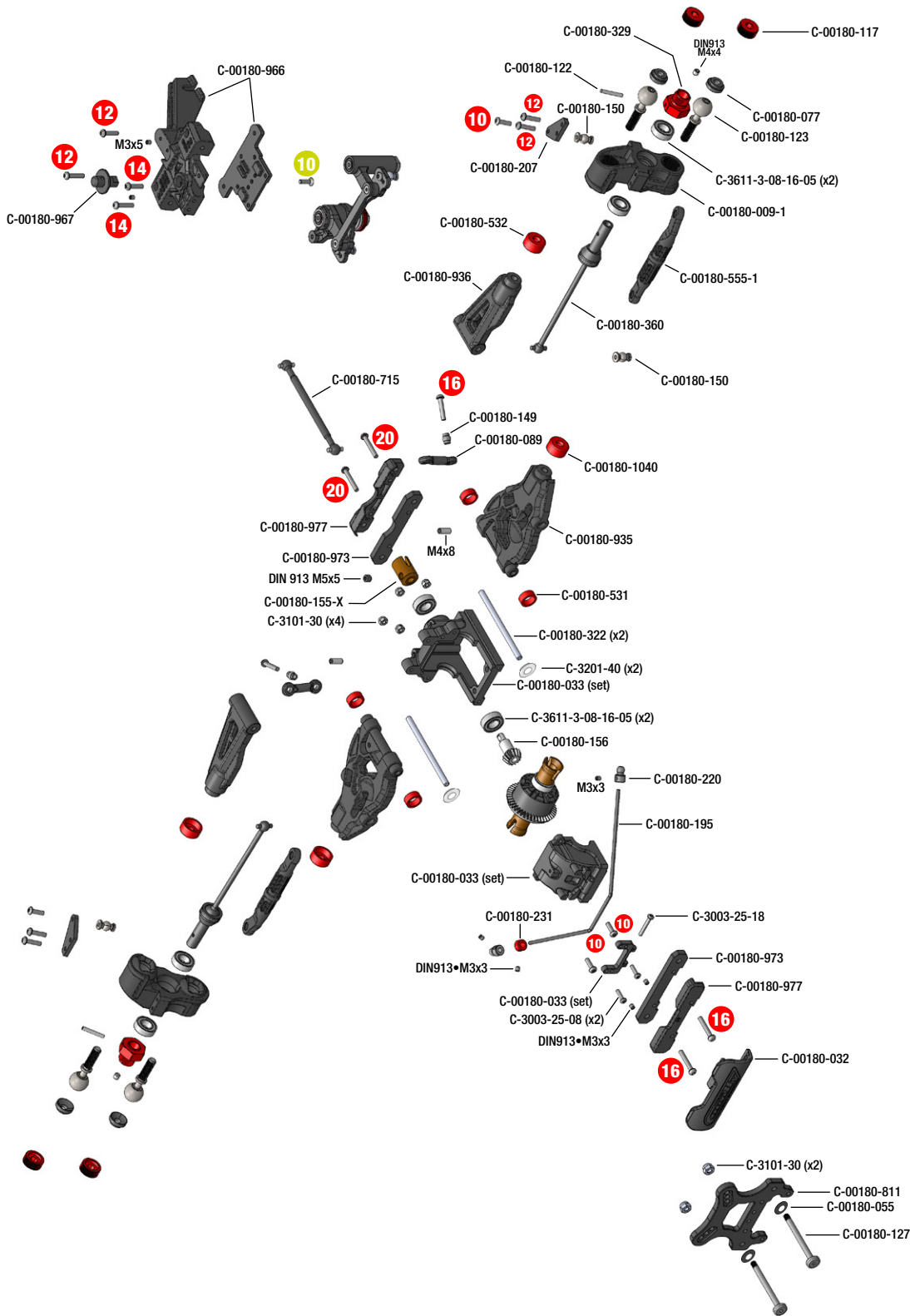

HEX BUTTON HEAD SCREWS DIN 7380 - STEEL - 10 PCS	
10	M3x10mm #C-3003-30-10
12	M3x12mm #C-3003-30-12
14	M3x14mm #C-3003-30-14
16	M3x16mm #C-3003-30-16
20	M3x20mm #C-3003-30-20
22	M3x22mm #C-3003-30-22

OPTION



**Aluminium 7075
Hard Anodised**

C-00180-854
Gearbox Case Set
Fit FRONT or REAR

Front Shock-tower - Screws description

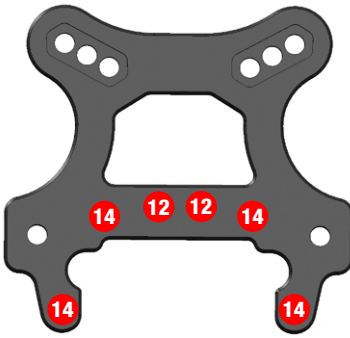

14 12 12 14 14

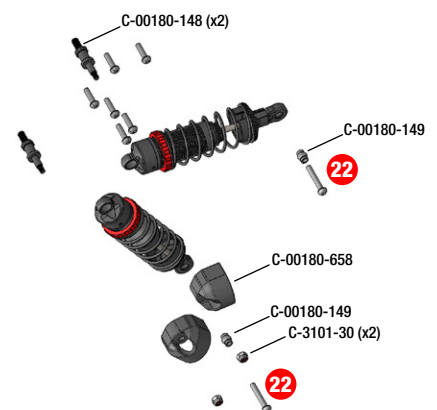

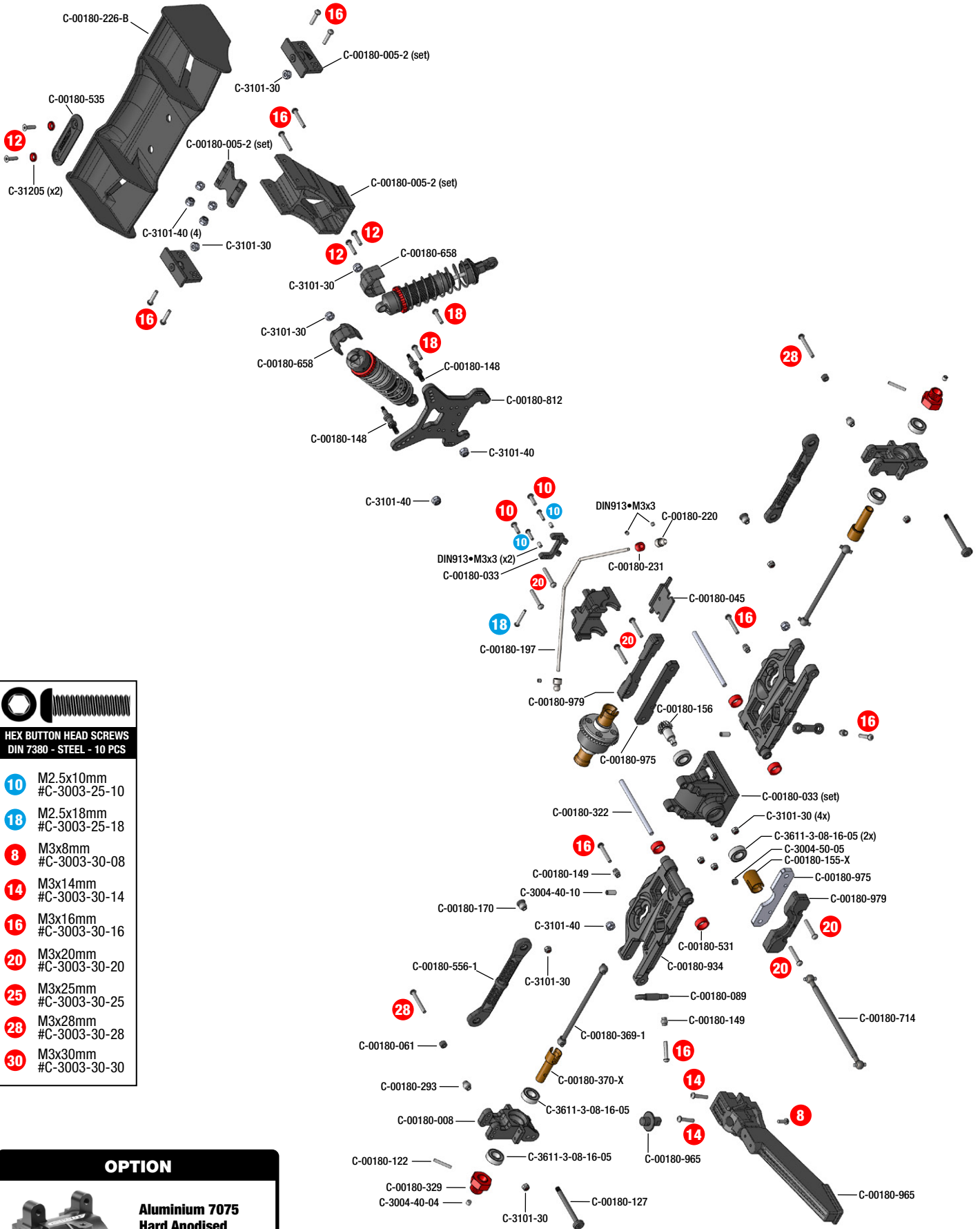

HEX BUTTON HEAD SCREWS DIN 7380 - STEEL - 10 PCS	
10	M2.5x10mm #C-3003-25-10
18	M2.5x18mm #C-3003-25-18
8	M3x8mm #C-3003-30-08
14	M3x14mm #C-3003-30-14
16	M3x16mm #C-3003-30-16
20	M3x20mm #C-3003-30-20
25	M3x25mm #C-3003-30-25
28	M3x28mm #C-3003-30-28
30	M3x30mm #C-3003-30-30

OPTION

**Aluminium 7075
Hard Anodised**

C-00180-854
Gearbox Case Set
Fit FRONT or REAR

OPTION



Aluminium / Steel

C-00180-685
Center Diff Assembly -
46T Main Gear - Xpert
Build - 100K Oil Filled

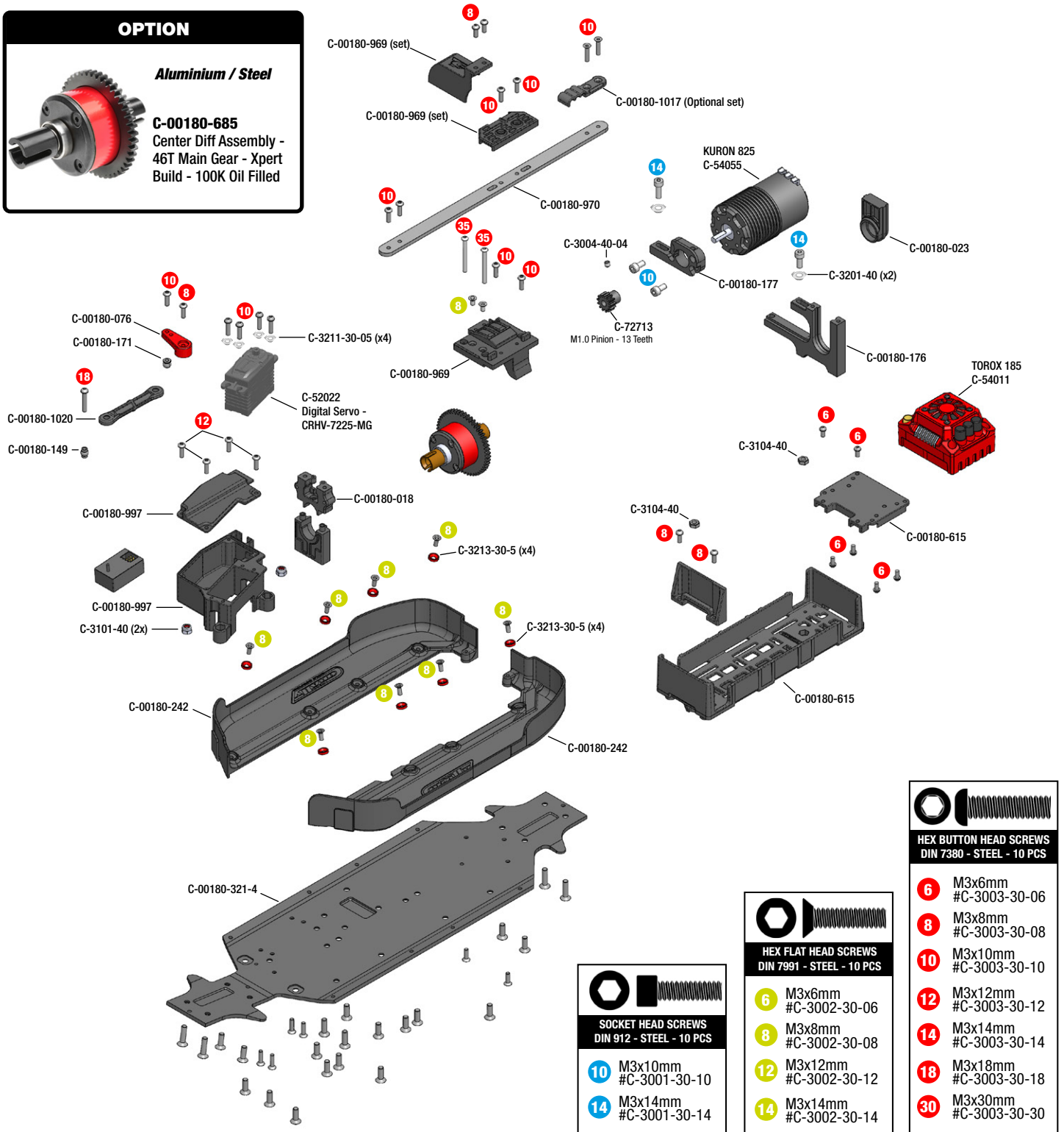

Parts shown include: C-00180-969 (set), C-00180-1017 (Optional set), C-00180-970, C-3004-40-04, KURON 825 C-54055, C-00180-023, C-3201-40 (x2), C-00180-177, C-00180-176, TOROX 185 C-54011, C-3104-40, C-00180-615, C-00180-076, C-00180-171, C-3211-30-05 (x4), C-52022 Digital Servo - CRHV-7225-MG, C-00180-1020, C-00180-149, C-00180-997, C-00180-018, C-3213-30-5 (x4), C-3101-40 (2x), C-00180-997, C-00180-242, C-00180-242, C-00180-321-4, C-00180-969, C-72713 M1.0 Pinion - 13 Teeth, C-3104-40, C-00180-615, C-3213-30-5 (x4), C-3213-30-5 (x4).

SOCKET HEAD SCREWS
DIN 912 - STEEL - 10 PCS

- 10 M3x10mm #C-3001-30-10
- 14 M3x14mm #C-3001-30-14

HEX FLAT HEAD SCREWS
DIN 7991 - STEEL - 10 PCS

- 6 M3x6mm #C-3002-30-06
- 8 M3x8mm #C-3002-30-08
- 12 M3x12mm #C-3002-30-12
- 14 M3x14mm #C-3002-30-14

HEX BUTTON HEAD SCREWS
DIN 7380 - STEEL - 10 PCS

- 6 M3x6mm #C-3003-30-06
- 8 M3x8mm #C-3003-30-08
- 10 M3x10mm #C-3003-30-10
- 12 M3x12mm #C-3003-30-12
- 14 M3x14mm #C-3003-30-14
- 18 M3x18mm #C-3003-30-18
- 30 M3x30mm #C-3003-30-30

CHASSIS - SCREWS DESCRIPTION

- M3x10mm DIN7991 #C-3002-30-10
- M4x12mm DIN7991 #C-3002-40-12
- M4x14mm DIN7991 #C-3002-40-14
- M4x16mm DIN7991 #C-3002-40-16

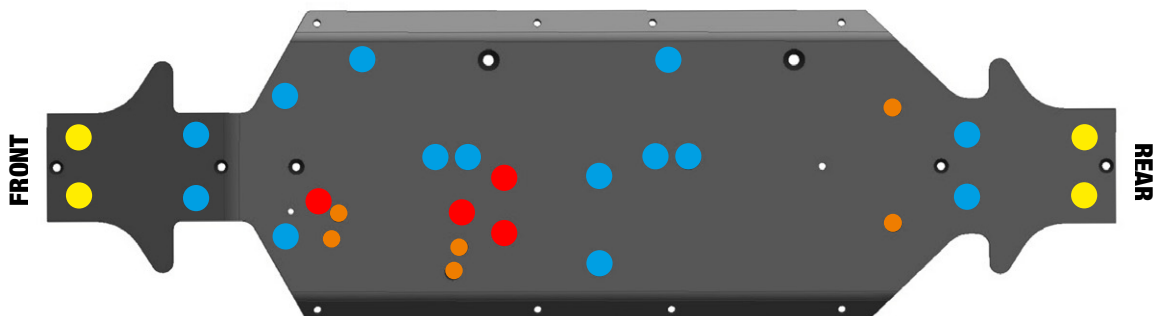

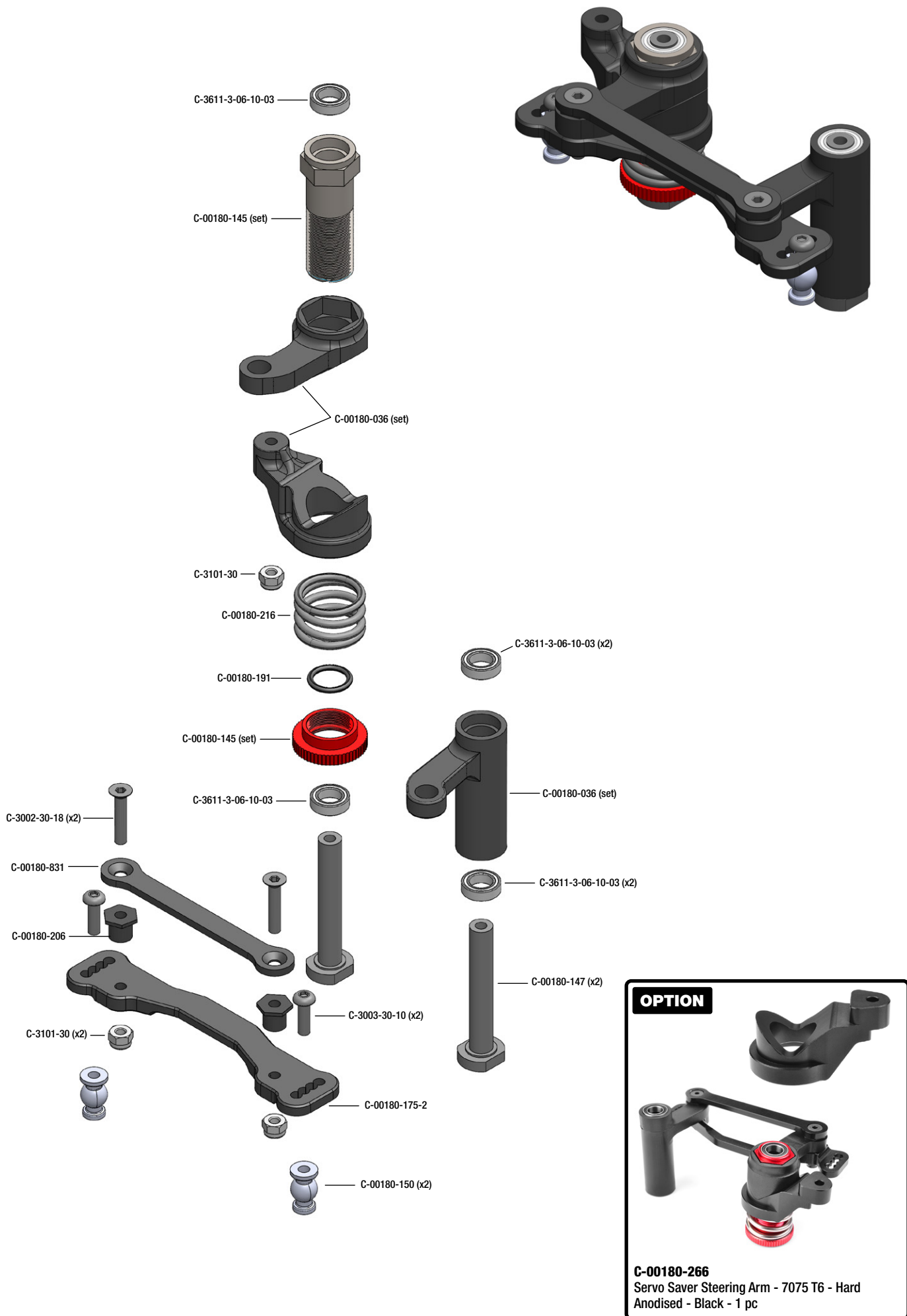

OPTION

C-00180-266
 Servo Saver Steering Arm - 7075 T6 - Hard Anodised - Black - 1 pc



C-00180-004-1
Battery Strap - Hook & Loop
- 2 pcs



C-00180-005-2
Wing Mount - Adjustable -
Composite - 1 Set

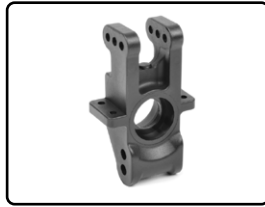

C-00180-008
Hub - Rear - Composite - 1 pc



C-00180-009-1
HD Steering Block (1pc) - Pillow
Ball Cup (2pcs) - Composite



C-00180-018
Centre Diff Bulkhead - Compos-
ite - 1 Set



C-00180-023
Motor Mount Centre Diff Insert -
Composite - 1 pc



C-00180-032
Bumper - Front - Rear - Com-
posite - 1 set



C-00180-033
Gearbox Case Set - Composite
- 1 Set



C-00180-036
Steering Bellcrank - Parts A-B-C
- Composite - 1 Set

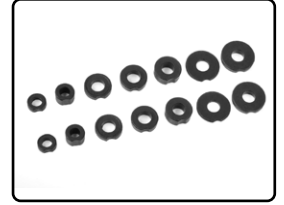

C-00180-055
Suspension Arm Shim - Com-
posite - 1 Set



C-00180-089
Anti-Roll Bar Ball Cups - Com-
posite - 4 pcs



C-00180-117
Pivot Ball Adjusting Nut - Alu-
minium - 4 pcs

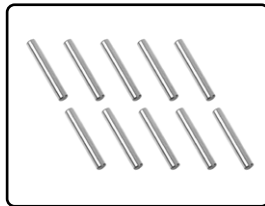

C-00180-122
Pin 2.5x17mm - Steel - 10 pcs



C-00180-123-1
Pivot Ball - Steel - 4 pcs



C-00180-127
Hinge Pin - Outer - Steel - 2 pcs



C-00180-145
Servo Saver Shaft w/ Nut -
Aluminium - 1 pc



C-00180-147
Servo Saver Post - Steel - 2 pcs



C-00180-148
Shock Screw - Steel - 4 pcs



C-00180-149
Ball - 5.8mm - Steel - 4 pcs



C-00180-150
Ball Shouldered - 6.8mm - Steel
- 4 pcs



C-00180-170
Ball - 6.8mm - Steel - 2 pcs



C-00180-171
Threaded Ball - 6mm - Steel -
2 pcs



C-00180-176
Motor Bulkhead - Aluminium
- 1 pc



C-00180-177
Motor Mount - Aluminium - 1 pc

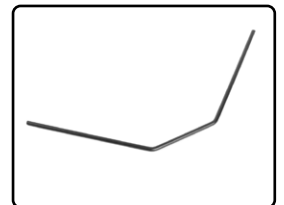

C-00180-195
Anti-Roll Bar - 2.6mm - Front
- 1 pc



C-00180-175-2
Steering Rack - Aluminium 7075
- 1 pc



C-00180-201
Anti-Roll Bar - 2.6mm - Rear
- 1 pc

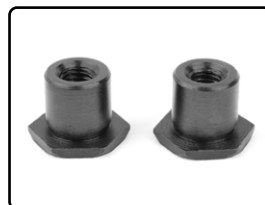

C-00180-206
Steering Rack Bushing - Steel
- 2 pcs



C-00180-207
Steering Block Arms - Alumi-
nium - 2 pcs



C-00180-216
Servo Saver Spring - 1 pc



C-00180-220
Ball End 5.8mm - for Anti Roll
Bar - Steel - 4 pcs



C-00180-226-B
Wing - Composite - 1 pc

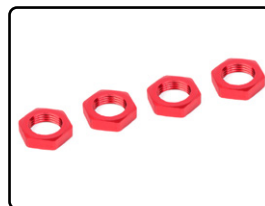

C-00180-230
Wheel Nut - Aluminium -
Ribbed - 4 pcs



C-00180-231
Collar - for Anti-roll Bar - Alu-
minium - 1 pc



C-00180-242
Side Guards - Left-Right - Com-
posite - 1 Set



C-00180-293
Ball 6.8mm - Steel - 4 pcs

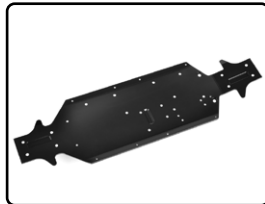

C-00180-321-4
Chassis - Buggy - Aluminium
3mm - Black - 1 pc



C-00180-322
Suspension Arm Pivot Pin - Low-
er Inner - Fr/Re - Steel - 2 pcs



C-00180-329
Wheel Hex Adapter - Wide RTR
- Aluminium - 2 pcs



C-00180-360
Universal Joint Drive Shaft -
Buggy - Front - 1 pc



C-00180-369-1
Dogbones - Short - Rear - Steel
- 2 pcs



C-00180-370-X
PRO Drive Axle - Buggy - Rear -
Swiss Spring Steel - 2 pcs



C-00180-372
Servo Arm - Steering - Alu -
1 pc

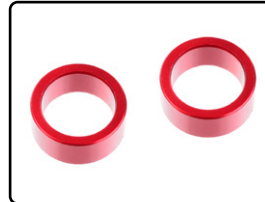

C-00180-531
HDA Suspension Arm Insert -
Inner - Aluminium - Red - 2 pcs



C-00180-535
Wing Washer - Large - Com-
posite - 1 Pc



C-00180-555-1
Steering Links - 77mm - Com-
posite - 2 pcs



C-00180-556-1
Camber Links Rear - 93mm -
Composite - 2 pcs



C-00180-615
Battery Tray - Large - Compos-
ite - 1 Pc

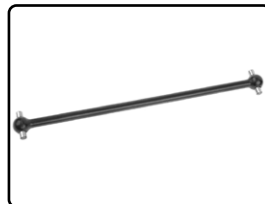

C-00180-714
Drive Shaft - Centre - Rear -
110mm - Steel - 1 pc

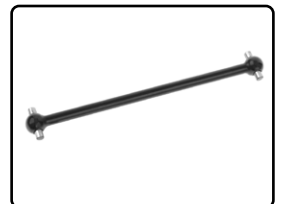

C-00180-715
Drive Shaft - Centre - Front-
85,5mm - Steel - 1 pc



C-00180-811
Shock Tower - Buggy - 4mm -
Aluminium - Front - 1 pc



C-00180-812
Shock Tower - Buggy - 4mm -
Aluminium - Rear - 1 pc



C-00180-831
Steering Rack - Dual Stiffener -
Aluminium - 1 Pc



C-00180-934
Suspension Arm - Lower - Rear
- Composite - 1 pc



C-00180-935
Suspension Arm - Lower - Front
- Composite - 1 pc



C-00180-936
Suspension Arm - Upper - Front
- Composite - 1 pc



C-00180-965
Chassis Brace - Buggy - Rear -
Composite - 1 pc

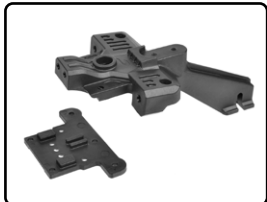

C-00180-966
Chassis Brace - Buggy - Front -
Composite - 1 pc



C-00180-967
Body Post - Composite - 2 pcs



C-00180-969
Center Diff Plate - Pinion Gear
Cover - XB - Composite - 1 pc



C-00180-970
Chassis Brace - Buggy - Alu-
minium 3mm - 1 pc



C-00180-973
Suspension Arm Mount - XB -
Front - 4mm Aluminum - 1 set



C-00180-975
Suspension Arm Mount - XB -
Rear - 4mm Aluminum - 1 set



C-00180-977
Suspension Arm Mount Covers
- Front - Composite - 1 Set



C-00180-979
Suspension Arm Mount Covers
- Rear - Composite - 1 Set



C-00180-997
Servo Mount - Receiver Box -
Composite - 1 Set



C-00180-1020
Servo Steering Link - Compos-
ite - 1 pc



C-00180-1040
HDA Susp. Arm Insert - Outer -
Spacer 2.5mm - Alum - Red - 2 pcs



C-54011
Speed Controller - TOROX 185 -
Brushless - 2-6S



C-52022
Digital Servo - CRHV-7225-MG
- High Voltage - Metal Gear

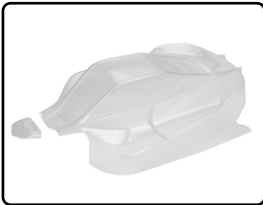

C-00180-1168
SPARK XB6 - Body - Clear -
Buggy - 1 pc



Body Decal Sheet
C-00180-1169-R • Red - 1 pc
C-00180-1169-B • Blue - 1 pc
C-00180-1169-G • Green - 1 pc



Painted Body - SPARK XB6
C-00180-1168-R • Red - 1 pc
C-00180-1168-B • Blue - 1 pc
C-00180-1168-G • Green - 1 pc

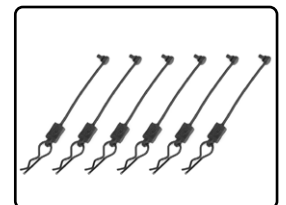

C-00180-614
Body Clip Retainer w/ Body clip
- Black - 6 pcs



C-00180-611
Off-Road 1/8 Buggy Tires - Xpirt
- Low Profile - Rims - 1 pair



C-54055
Brushless Motor - Kuron 825 -
4-Pole - 2050 KV - Sensorless



C-72713
M1.0 Pinion - Hardened Steel -
13 Teeth - Shaft Dia. 5mm

**SHOCK ABSORBER - SPARE PARTS - AMORTISSEUR - PIÈCES DE RECHANGE -
STOSSDÄMPFER - ERSATZTEILE - SCHOKDEMPEM - ONDERDELEN**

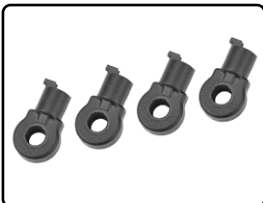

C-00180-770
HD Shock End - Short - Com-
posite - 4 pcs



C-00180-164
Shock Shaft - 66mm - Rear -
Steel - 2 pcs



C-00180-165
Shock Shaft - 55mm - Front -
Steel - 2 pcs

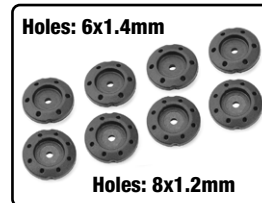

Holes: 6x1.4mm
Holes: 8x1.2mm
C-00180-768
Shock Piston Heavy Duty -
4mm thick - 1 Set

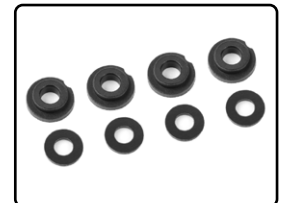

C-00180-078
Shock Body Insert - Washer -
Composite - 1 set



C-00180-188
O-Ring - Silicone - 4x8mm -
5 pcs

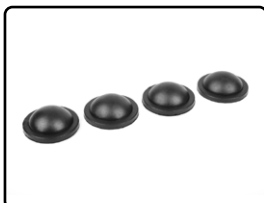

C-00180-189
Shock Bladders - Silicone -
4 pcs

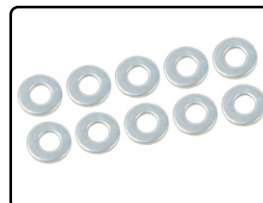

C-00180-190
Shock Washer - 2.5x6x0.5mm -
Steel - 10 pcs



C-00180-138
Shock Cap - Lower - Composite
- 2 pcs



C-00180-136
Shock Collar - Aluminium -
Hard Anodised - 2 pcs

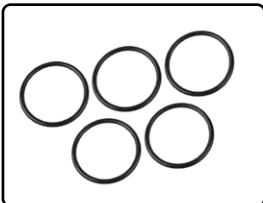

C-00180-192
O-Ring - Silicone -
16.2x19.8mm - 5 pcs

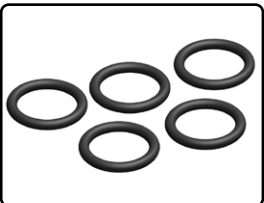

C-00180-191
O-Ring - Silicone - 9x12mm
- 5 pcs



C-00180-135
Shock Body - Front - Aluminium
- Hard Anodised - 1 pc



C-00180-137
Shock Body - Rear - Aluminium
- Hard Anodised - 1 pc



C-00180-133
Shock Cap - Aluminium - Hard
Anodised - 2 pcs



C-00180-658
Shock Cap Cover - RTR - Com-
posite - 2 pcs

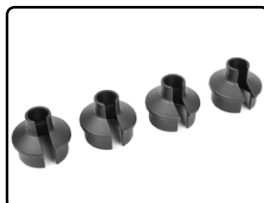

C-00180-029
Shock Spring Cup - Composite
- 4 pcs

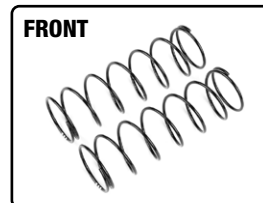

FRONT
C-00180-628
Shock Spring - Hard - 1.8mm -
75/77mm - 2 pcs

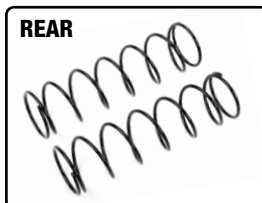

REAR
C-00180-291
Shock Spring - Hard - 1.8mm -
84/86mm - 2 pcs



C-3101-25-6
Steel Nylostop Nut M2.5 - Black
Coated - 10 pcs

FRONT & REAR DIFFERENTIAL - SPARE PARTS



C-00180-090-1
Center Diff set - Case + diff
internals - 1 set



C-00180-156
Bevel Pinion 13T - Steel - 1 pc



C-00180-178
Diff. Bevel Gear 43T - Steel -
1 pc



C-00180-179
Planetary Diff. Gears - Steel -
1 Set



C-00180-184
Gear Diff. Pin - Steel - 2 pcs

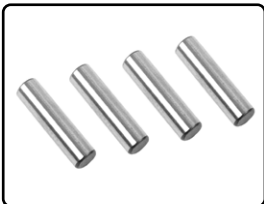

C-00180-205
Diff. Outdrive Pin - 2x11,8mm -
Steel - 4 pcs



C-00180-098
Diff Case - FR-RE - Composite
- 1 pc

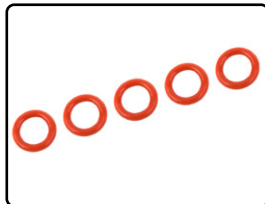

C-00180-182
O-Ring - Silicone - 5x8mm -
5 pcs

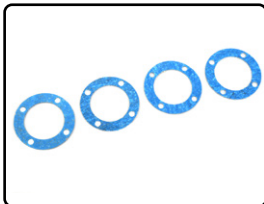

C-00180-183
Diff. Gasket - 4 pcs



C-00180-153-X
PRO Diff. Outdrive Cup - Swiss
Spring Steel - 2 pcs



C-00180-155-X
PRO Pinion Outdrive Cup -
Swiss Spring Steel - 2 pcs

CENTRE DIFFERENTIAL - SPARE PARTS



C-00180-154-X
PRO Centre Diff. Outdrive Cup -
Swiss Spring Steel - 2 pcs

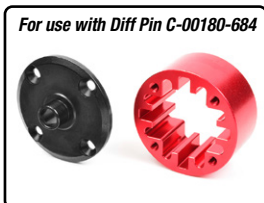

For use with Diff Pin C-00180-684

C-00180-686
Diff Case - Centre - Aluminium.
- 1 pc

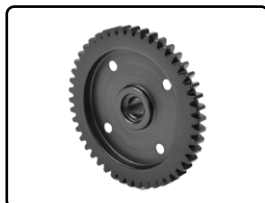

C-00180-091
Spur Gear 46T - Steel - 1 pc

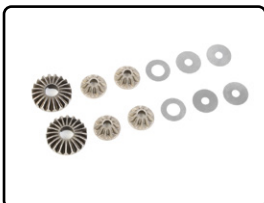

C-00180-179
Planetary Diff. Gears - Steel -
1 Set



For use with C-00180-686

C-00180-684
Gear Diff Pin - 3.5x29.8mm -
for C-00180-686 - Steel - 4 pcs



C-00180-183-1
Central Diff. Gasket - 4 pcs

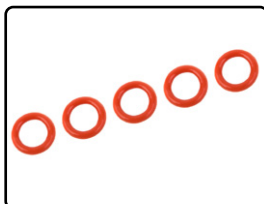

C-00180-182
O-Ring - Silicone - 5x8mm -
5 pcs

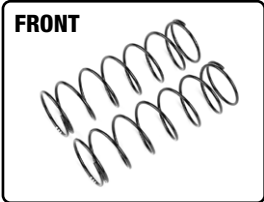

FRONT

C-00180-626
Shock Spring - Soft - 1.4mm -
75/77mm - 2 pcs

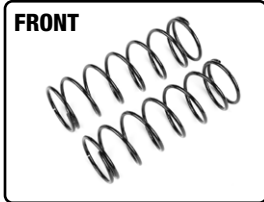

FRONT

C-00180-627
Shock Spring - Medium -
1.6mm - 75/77mm - 2 pcs

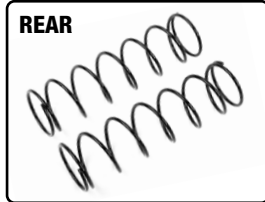

REAR

C-00180-289
Shock Spring - Soft - 1.4mm -
84/86mm - 2 pcs

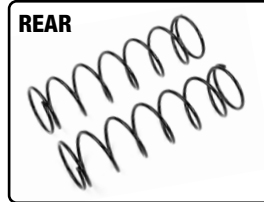

REAR

C-00180-290
Shock Spring - Medium -
1.6mm - 84/86mm - 2 pcs

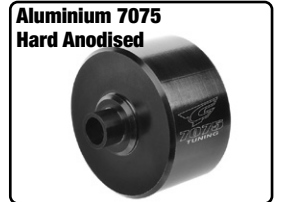

Aluminium 7075
Hard Anodised

C-00180-410
Xtreme Diff Case - 30mm -
FR / RE - Made in Italy - 1 pc

Anti-Roll Bar - Front - Rear

	Front	Rear
	C-00180-199 • - 2.0mm	C-00180-200 • - 2.4mm
	C-00180-198 • - 2.2mm	C-00180-201 • - 2.6mm
	C-00180-197 • - 2.4mm	C-00180-202 • - 2.8mm
	C-00180-196 • - 2.5mm	C-00180-203 • - 3.0mm
	C-00180-195 • - 2.6mm	



C-00180-376
Off-Road 1/8 Buggy Tires -
Glued on Black Rims - 1 pair



M1.0 Pinion - Hardened Steel -
Shaft Diameter 5mm
C-72713 • 13 Teeth (factory)
C-72715 • 15 Teeth
C-72717 • 17 Teeth



C-00180-1017
Motor Wire Holder - Composite
- 1 Set



STEEL SCREWS

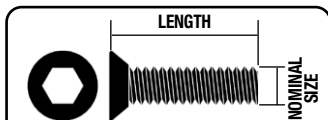

HEX FLAT HEAD SCREWS
DIN 7991 - STEEL - 10 PCS

REF	NOMINAL SIZE	LENGTH MM
C-3002-25-06	M2.5	6
C-3002-25-08	M2.5	8
C-3002-25-10	M2.5	10
C-3002-25-12	M2.5	12
C-3002-25-16	M2.5	16
C-3002-25-18	M2.5	18
C-3002-25-20	M2.5	20
C-3002-30-06	M3	6
C-3002-30-08	M3	8
C-3002-30-10	M3	10
C-3002-30-12	M3	12
C-3002-30-14	M3	14
C-3002-30-16	M3	16
C-3002-30-18	M3	18
C-3002-30-20	M3	20
C-3002-30-25	M3	25
C-3002-30-35	M3	35
C-3002-40-08	M4	8
C-3002-40-10	M4	10
C-3002-40-12	M4	12
C-3002-40-14	M4	14
C-3002-40-16	M4	16
C-3002-40-18	M4	18
C-3002-40-20	M4	20
C-3002-40-25	M4	25
C-3002-40-30	M4	30

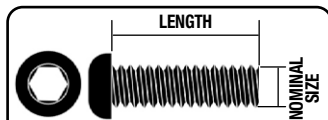

HEX BUTTON HEAD SCREWS
DIN 7380 - STEEL - 10 PCS

REF	NOMINAL SIZE	LENGTH MM
C-3003-25-06	M2.5	6
C-3003-25-08	M2.5	8
C-3003-25-10	M2.5	10
C-3003-25-12	M2.5	12
C-3003-25-16	M2.5	16
C-3003-25-18	M2.5	18
C-3003-25-20	M2.5	20
C-3003-30-06	M3	6
C-3003-30-08	M3	8
C-3003-30-10	M3	10
C-3003-30-12	M3	12
C-3003-30-14	M3	14
C-3003-30-16	M3	16
C-3003-30-18	M3	18
C-3003-30-20	M3	20
C-3003-30-25	M3	25
C-3003-30-35	M3	35
C-3003-40-08	M4	8
C-3003-40-10	M4	10
C-3003-40-12	M4	12
C-3003-40-14	M4	14
C-3003-40-16	M4	16
C-3003-40-18	M4	18
C-3003-40-20	M4	20
C-3003-40-25	M4	25
C-3003-40-30	M4	30

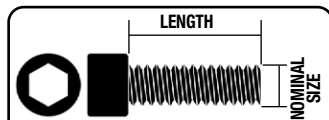

HEX SOCKET HEAD SCREWS
DIN 912 - STEEL - 10 PCS

REF	NOMINAL SIZE	LENGTH MM
C-3000-25-06	M2.5	6
C-3000-25-08	M2.5	8
C-3000-25-10	M2.5	10
C-3000-25-12	M2.5	12
C-3000-25-16	M2.5	16
C-3000-25-18	M2.5	18
C-3000-25-20	M2.5	20
C-3000-30-06	M3	6
C-3000-30-08	M3	8
C-3000-30-10	M3	10
C-3000-30-12	M3	12
C-3000-30-14	M3	14
C-3000-30-16	M3	16
C-3000-30-18	M3	18
C-3000-30-20	M3	20
C-3000-30-25	M3	25
C-3000-30-35	M3	35
C-3000-40-08	M4	8
C-3000-40-10	M4	10
C-3000-40-12	M4	12
C-3000-40-14	M4	14
C-3000-40-16	M4	16
C-3000-40-18	M4	18
C-3000-40-20	M4	20
C-3000-40-25	M4	25
C-3000-40-30	M4	30

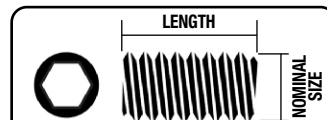

HEX SET SCREWS
DIN 916 - STEEL - 10 PCS

REF	NOMINAL SIZE	LENGTH MM
C-3004-30-03	M3	3
C-3004-30-05	M3	5
C-3004-30-08	M3	8
C-3004-30-10	M3	10
C-3004-30-12	M3	12
C-3004-30-20	M3	20
C-3004-40-04	M4	4
C-3004-40-06	M4	6
C-3004-40-08	M4	8
C-3004-40-10	M4	10
C-3004-40-12	M4	12
C-3004-50-04	M5	4
C-3004-50-05	M5	5

TITANIUM SCREWS

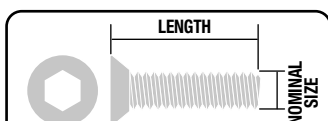

HEX FLAT HEAD SCREWS
TITANIUM - 10 PCS

REF	NOMINAL SIZE	LENGTH MM
C-3022-30-06	M3	6
C-3022-30-08	M3	8
C-3022-30-10	M3	10
C-3022-30-12	M3	12
C-3022-30-14	M3	14
C-3022-30-16	M3	16
C-3022-30-18	M3	18
C-3022-30-20	M3	20
C-3022-40-08	M4	8
C-3022-40-10	M4	10
C-3022-40-12	M4	12
C-3022-40-16	M4	16
C-3002-40-20	M4	20

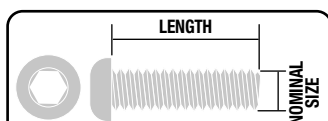

HEX BUTTON HEAD SCREWS
TITANIUM - 10 PCS

REF	NOMINAL SIZE	LENGTH MM
C-3023-30-06	M3	6
C-3023-30-08	M3	8
C-3023-30-10	M3	10
C-3023-30-12	M3	12
C-3023-30-16	M3	16
C-3023-30-20	M3	20
C-3023-30-25	M3	25
C-3023-40-06	M4	6
C-3023-40-08	M4	8
C-3023-40-10	M4	10
C-3023-40-12	M4	12
C-3023-40-16	M4	16
C-3023-40-20	M4	20
C-3023-40-25	M4	25

NUTS

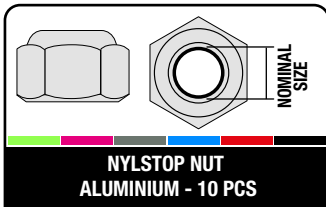

REF	NOMINAL SIZE	COLOR
C-3106-20-0	M2	Gold
C-3106-20-1	M2	Green
C-3106-20-2	M2	Purple
C-3106-20-3	M2	Gun
C-3106-20-4	M2	Blue
C-3106-20-5	M2	Red
C-3106-20-6	M2	Black
C-3106-30-0	M3	Gold
C-3106-30-1	M3	Green
C-3106-30-2	M3	Purple
C-3106-30-3	M3	Gun
C-3106-30-4	M3	Blue
C-3106-30-5	M3	Red
C-3106-30-6	M3	Black
C-3106-40-0	M4	Gold
C-3106-40-1	M4	Green
C-3106-40-2	M4	Purple
C-3106-40-3	M4	Gun
C-3106-40-4	M4	Blue
C-3106-40-5	M4	Red
C-3106-40-6	M4	Black
C-3106-50-0	M5	Gold
C-3106-50-1	M5	Green
C-3106-50-2	M5	Purple
C-3106-50-3	M5	Gun
C-3106-50-4	M5	Blue
C-3106-50-5	M5	Red
C-3106-50-6	M5	Black

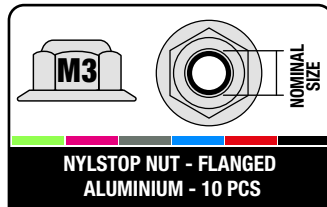

REF	NOMINAL SIZE	COLOR
C-3107-30-0	M3	Gold
C-3107-30-1	M3	Green
C-3107-30-2	M3	Purple
C-3107-30-3	M3	Gun
C-3107-30-4	M3	Blue
C-3107-30-5	M3	Red
C-3107-30-6	M3	Black
C-3107-40-0	M4	Gold
C-3107-40-1	M4	Green
C-3107-40-2	M4	Purple
C-3107-40-3	M4	Gun
C-3107-40-4	M4	Blue
C-3107-40-5	M4	Red
C-3107-40-6	M4	Black
C-3107-50-0	M5	Gold
C-3107-50-1	M5	Green
C-3107-50-2	M5	Purple
C-3107-50-3	M5	Gun
C-3107-50-4	M5	Blue
C-3107-50-5	M5	Red
C-3107-50-6	M5	Black

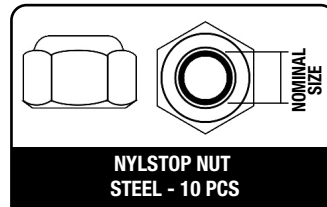

REF	NOMINAL SIZE	COLOR
C-3101-20-6	M2	Black
C-3101-25	M2.5	Silver
C-3101-25-6	M2.5	Black
C-3101-30	M3	Silver
C-3101-30-6	M3	Black
C-3101-40	M4	Silver
C-3101-40-6	M4	Black

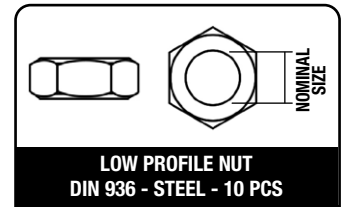

REF	NOMINAL SIZE	COLOR
C-3104-40	M4	Silver
C-3104-50	M5	Silver

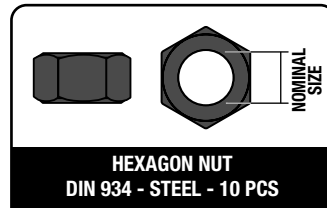

REF	NOMINAL SIZE	COLOR
C-3103-20-6	M2	Black
C-3103-25-6	M2.5	Black
C-3103-30-6	M3	Black
C-3103-40-6	M4	Black
C-3103-50-6	M5	Black

BALL BEARINGS

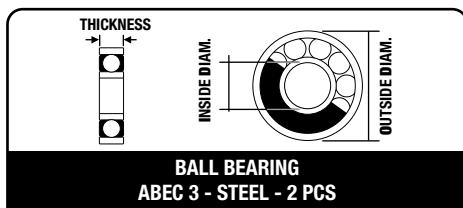

REF	ID MM	OD MM	TH MM
C-3611-3-05-08-03	5	8	3
C-3611-3-05-10-04	5	10	4
C-3611-3-06-10-03	6	10	3
C-3611-3-08-16-05	8	16	5
C-3611-3-10-15-04	10	15	4
C-3611-3-12-21-05	12	21	5

SHIMS

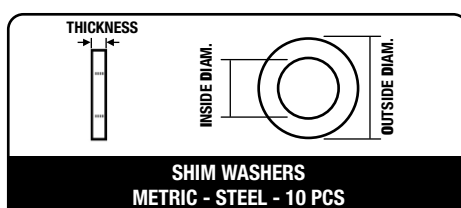

REF	ID MM	OD MM	TH MM
C-3301-04-06-01	4	6	0.1
C-3301-06-08-01	6	8	0.1
C-3301-08-10-01	8	10	0.1
C-3301-13-16-01	13	16	0.1

STEEL WASHERS

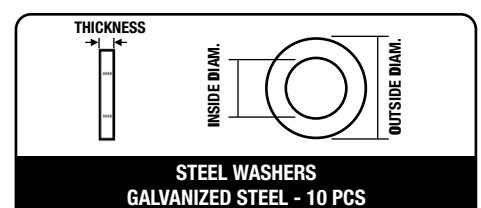

REF	ID MM	OD MM	TH MM
C-3201-30	3.2	7	0.5
C-3201-40	4.3	9	0.8
C-3201-60	6.4	12	1.6

DECLARATION OF CONFORMITY
EU-Konformitätserklärung/ Déclaration de Conformité UE

(in accordance with ISO/IEC 17050-1) / (in Übereinstimmung mit ISO/IEC 17050-1) /
 (Conformément à la norme ISO/IEC 17050-1)

Description : **SPARK XB6 - BUGGY 4WD - 1/8 -RTR**
 Item Number: **C-00285**

This declaration is issued under the sole responsibility of the manufacturer.
 Die alleinige Verantwortung für die Ausstellung dieser Erklärung trägt der Hersteller.
 La présente déclaration est établie sous la seule responsabilité du fabricant.

Product(s)/Produkt(e)/ Produit(s) : **SPARK XB6 - BUGGY 4WD - 1/8 -RTR**

The object of declaration described above is in conformity with the relevant Union harmonization Legislation, specifically the requirements of the specifications listed below, following the provisions of the European RED Directive 2014/53/EU:
 Der Gegenstand dieser Erklärung ist konform mit den Harmonisierungsrechtsvorschriften der Europäischen Union, insbesondere mit den unten aufgeführten Bestimmungen, und folgt der europäischen RED Direktive 2014/53/EU:
 L'objet de la déclaration décrit ci-dessus est conforme à la législation pertinente en matière d'harmonisation de l'Union européenne, en particulier les exigences des spécifications énumérées ci-dessous, conformément aux dispositions des directives européennes RED 2014/53/EU:

EN 300 440 V2.1.1:2017	EN 301 489-3 V1.6.1:2013
EN 301 489-1 V2.1.1:2017	EN 60950-1:2006+A11:2009+A1:2010+A12:2011+A2:2013
EN 62479:2010	EN 55024:2010+A1:2015
EN 55032:2015	EN 61000-3-3:2013
EN 61000-3-2:2014	

JSP GROUP INTL • Geelseweg, 80 • 2250 Olen • Belgium

Signed for and on behalf of/ Unterzeichnet für und im Namen von/ Signé pour et au nom de :

Place/Ort/Lieu and Date/Datum/Data : **Olen, Belgium, 09 June 2023**

Name/Nom: **Stefan Engelen**
 Title/Titel/Titre : **Ceo**

Signature/Unterschrift :



EQUIPMENT AUTHORIZATION is hereby issued to the named GRANTEE JSP GROUP INTL BVBA / CORALLY, and is VALID ONLY for the equipment identified hereon for use under the Commission's Rules and Regulations listed below.

FCC IDENTIFIER : 2ASFS-C59060
 Name of Grantee : JSP GROUP INTL BVBA / CORALLY
 Equipment Class : Part 15 Low Power Communication Device Transmitter
 Notes : Corally CT2R - C-59060
 FCC Rules : 15C
 Frequency Range (MHZ) : 2410.0 - 2480.0

FACTORY PRO TOOL



Factory Pro Tool - Hardened Tip - Alu Grip - Hex

TEAM CORALLY - SHOCK PLIERS

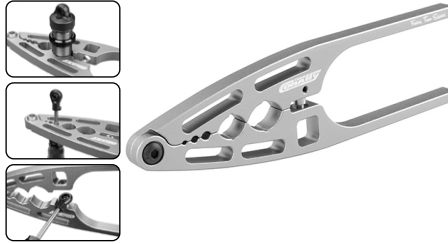

Team Corally - Shock Pliers

PINION CADDY M1.0



Team Corally - Pinion Caddy M1.0 - 9 Pinions - ø5mm

TEAM CORALLY - GREASE



Lithium Grease - Blue Grease - Ball Diff Grease - Copper Grease

TEAM CORALLY - SILICONE OILS



Shock Oils 60ml - 150ml - CST or WT - 100 >1000 CPS
Diff Oils 60ml - 2000 >2 000 000 CPS

TEAM PIT GEAR



A range of quality equipment for the transport and protection of your equipment.

TEAM CORALLY - PINIONS



Discover our range of Precision CNC-Cut MOD-1.0 Pinions for motors with a ø 5.0mm motor shaft

SPORT RACING - LIPO



Team Corally - Sport Racing 50C - 4S or 6S - XT-90 - Hard Case

ELECTRONIC



A range of high quality electronic equipment for the best performance.



Discover all these products and more on the website www.corally.com

Découvrez tous ces produits et bien plus encore sur le site web www.corally.com

Entdecken Sie all diese Produkte und mehr auf der Website www.corally.com

Ontdek al deze producten en meer op de website www.corally.com

This manual is an edition of Corally, a division of JSP GROUP INTL nv, Geelseweg 80, B-2250 Olen, Belgium. This manual is protected by a copyright and nothing from this edition may be reproduced or used without any prior written authorisation. Whilst every effort has been made to ensure the accuracy of the information in this manual, errors creep in and Corally can accept no responsibility for failures, wrong specifications, accuracy of colours, losses or damages caused. Corally denies any responsibility claims or damages caused by use of our products. Corally is not responsible for product / parts / specifications / Colour changes or availability of these products.

WWW.CORALLY.COM

TEAM
CORALLY

WORLD CHAMPIONS



WWW.CORALLY.COM

Team Corally is a registered trademark licensed to
JSP Group Intl bvba • Geelseweg 80 • B-2250 OLEN • Belgium
Tel: +32 14 25 92 94 • Info@corally.com