



06051-0379

LEVEL 3

1 2 3 4 5



TIE FIGHTER™

Beiliegenden Sicherheitstext beachten / Please note the enclosed safety advice

- DE Beiliegenden Sicherheitstext beachten und nachschlagbereit halten.
- GB Please note the enclosed safety advice and keep safe for later reference.
- FR Respecter les consignes de sécurité ci-jointes et les conserver à portée de main.
- NL Houdt u aan de bijgaande veiligheidsinstructies en hou deze steeds bij de hand.
- IT Seguire le avvertenze di sicurezza allegate e tenerle a portata di mano.
- ES Observar y siempre tener a disposición este texto de seguridad adjunto.
- PT Ter em atenção o texto de segurança anexo e guardá-lo para consulta.

- NO Overhold vedlagte sikkerhedsanvisninger og hav dem liggende i nærheden.
- NO Ha alltid vedlagt sikkerhetstext klar til bruk.
- SE Beakta bifogad säkerhetstext och håll den i beredskap.
- FI Huomioi ja säilytä oheiset varoitukset.
- RU Соблюдать технику безопасности, сохранить инструкцию для дальнейших обращений.
- PL Przestrzegać załączonego tekstu dotyczącego bezpieczeństwa i mieć go zawsze pod ręką.
- CZ Dodržujte tento příložený bezpečnostní text a mějte ho po ruce.
- HU A mellékelt biztonsági szöveget vegye figyelembe és tartsa fellepozásra készen.

- SK Rešpektujte priložený bezpečnostný text a uchovajte ho pre budúce použitie.
- RO Respectați textul de siguranță atașat și păstrați-l la îndemână.
- BG Спазвайте приложения текст за безопасност и го дръжте под ръка за справки.
- SL Priloga varnostna navodila izvajajte in jih hranite na vsem dostopnem mestu.
- GR Λάβετε υπόψη σας το συννημένο κείμενο ασφαλείας και φυλάξτε το ώστε να ανατρέχετε σε αυτό όποτε χρειάζεται.
- TR Ektekiğüvenlik talimatlarını dikkate alıp, bakabileceğiniz bir şekilde muafaza ediniz.

© 2017 Revell GmbH, Henschelstr. 20-30, D-32257 Bünde. A subsidiary of Hobbico, Inc. © & ™ Lucasfilm Ltd.

REVELL IS THE REGISTERED TRADEMARK OF REVELL GMBH, GERMANY. www.revell.de

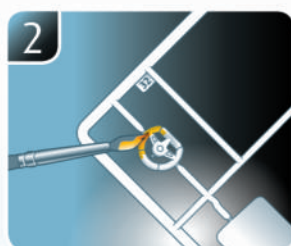

☞ Weitere Tipps und Tricks.
 ☞ Additional tips and tricks.
 ☞ Conseils et astuces supplémentaires.
 ☞ Andere tips en trucs.
 ☞ Ulteriori consigli e suggerimenti.
 ☞ Consejos y sugerencias adicionales.
 ☞ Mais dicas e truques.

☞ Flere tips og tricks.
 ☞ Flere tips og tricks.
 ☞ Ytterligare tips och tricks.
 ☞ Lisää vinkkejä ja niksejä.
 ☞ Другие советы и хитрости.
 ☞ Dalsze wskazówki i sugestie.
 ☞ Další tipy a rady.
 ☞ További ötletek és fogások.
 ☞ Dalsie tipy a triky.
 ☞ Alte sfaturi și trucuri.

☞ Други полезни съвети и трикове.
 ☞ Nadaljnji nasveti in zvižaje.
 ☞ Πρόσθετες συμβουλές και κόλπα.
 ☞ Diğer öneriler ve ipuçları.

www.revell.de



- DE Kleben
- FR Glue
- FR Coller
- NL Lijmen
- IT Incollare
- ES Pegamento
- PT Colar
- DK Lim
- NO Lime
- SE Limma
- FI Liimaa
- RU Клеить
- PL Przykleić
- CZ Slepění
- HU Ragasztás rá
- SK Lepiť
- NO Lipiti
- BG Залепете
- SI Prilepite
- GR ΚΟΛΛΗΣΤΕ
- TR Yapıştırma



- DE Nicht kleben
- FR Don't glue
- FR Ne pas coller
- NL Niet lijmen
- IT Non incollare
- ES No pegamento
- PT Não colar
- DK Lim ikke
- NO Ikke lime
- SE Limma inte
- FI Älä liimaa
- RU Не клеить
- PL Nie przyklejać
- CZ Nelepit
- HU Ne ragasztás rá
- SK Nelepiť
- NO Nu lipiti
- BG Не лепете
- SI Ne lepите
- GR Μην κολλήσετε
- TR Yapıştırmayın



- DE Bemalen
- FR Paint
- FR Peindre
- NL Beschilderen
- IT Colorare
- ES Pintar
- PT Pintar
- DK Mal
- NO Male
- SE Måla
- FI Maalaa
- RU Раскрасить
- PL Pomalować
- CZ Pomalovat
- HU Fesse be
- SK Natrief
- NO Vopsiti
- BG Боядисайте
- SI Robarvajte
- GR Βάψτε
- TR Boyama



- DE Zusammenbau Reihenfolge.
- FR Sequence of assembly.
- FR Ordre d'assemblage.
- NL Volgorde van montage.
- IT Sequenza di assemblaggio.
- ES Secuencia de montaje.
- PT Sequência de montagem.
- DK Samlerækkefølge.
- NO Monteringsrekkefølge.
- SE Montering ordningsföljd.
- FI Kokoamisjärjestys.
- RU Последовательность сборки.
- PL Kolejność montażu.
- CZ Pořadí složení.
- HU Összerakási sorrend.
- SK Poradie zostavenia.
- NO Ordinea asamblării.
- BG Последователност на сглобяване.
- SI Vrstni red sestavljanja.
- GR Σειρά τοποθέτησης.
- TR Parçaları birleştirme sırası.



- DE Klarsichtteile
- FR Clear parts
- FR Pièces transparentes
- NL Transparente onderdelen
- IT Parti trasparenti
- ES Piezas transparentes
- PT Peças transparentes
- DK Klare dele
- NO Klare deler
- SE Genomskinliga detaljer
- FI Läpinäkyvät osat
- RU Прозрачные детали
- PL Przejroczyste części
- CZ Průhledné díly
- HU Átlátszó alkatrészek
- SK Číre diely
- NO Piese transparente
- BG Прозрачни части
- SI Prozorni deli
- GR Διαφανή μέρη
- TR Şeffaf parçalar



- DE Bauteile trocknen lassen.
- FR Allow the parts to dry.
- FR Laisser sécher les pièces.
- NL Ouderdelen laten drogen.
- IT Lasciare asciugare i componenti.
- ES Dejar secar las piezas.
- PT Deixar as peças secar.
- DK Lad delene tørre.
- NO Tørk komponenter.
- SE Låt komponenterna torka.
- FI Anna rakenneosien kuivua.
- RU Дайте деталям высохнуть.
- PL Pozostawić elementy konstrukcji do wyschnięcia.
- CZ Nechte díly uschnout.
- HU Hagyja megszáradni az alkatrészeket.
- SK Konštrukčné diely nechajte vyschnúť.
- NO Lásati componentele să se usuce.
- BG Оставете сглобените части да изсъхнат.
- SI Osušite sestavne dele.
- GR Αφήστε τα μέρη να στεγνώσουν.
- TR Yapı parçalarını kurumaya bırakın.



- DE Bauanleitung sorgfältig lesen.
- FR Read the assembly instructions carefully.
- FR Lisez attentivement les instructions de montage.
- NL Bouwinstructies zorgvuldig doorlezen.
- IT Leggere attentamente le istruzioni per il montaggio.
- ES Lea cuidadosamente las instrucciones de montaje.
- PT Ler atentamente as instruções de montagem.
- DK Læs byggevejledningen omhyggeligt.
- NO Les byggeanvisningen nøye.
- SE Monteringsinstruktionerna skall läsas noggrant.
- FI Lue kokoamisohje huolellisesti.
- RU Внимательно прочитайте инструкцию по сборке.
- PL Dokładnie przeczytać instrukcję montażu.
- CZ Přečtě si pečlivě návod k obsluze.
- HU Figyelmesen olvassa el a szerelési útmutatót.
- SK Návod na montáž starostlivo prečítajte.
- NO Cititi cu atenție instrucțiunile de montare.
- BG Прочетете внимателно упътването за монтаж.
- SI Skrbno preberite navodila za sestavo.
- GR Διαβάστε προσεκτικά τις οδηγίες κατασκευής.
- TR Yapı kılavuzunu dikkatle okuyun.



- DE Abziehbild in Wasser einweichen und anbringen.
- FR Soak and apply decals.
- FR Mouiller et appliquer les décalcomanies.
- NL Transfer in water even laten weken en aanbrengen.
- IT Immergere la decalcomania nell'acqua e applicarla.
- ES Mojar y aplicar calcomanías.
- PT Amolecer o decalque em água e aplicar.
- DK Gør overførsbilledet vådt og sæt det på.
- NO Myk opp avtrekkingsbildet i vann og sett på.
- SE Blötlägg dekalen i vatten och sätt på den.
- FI Pehmitä siirtokuva vedessä ja siirrä paikalleen.
- RU Опустите переводную картинку в воду и нанесите её.
- PL Namoczyć kalkomanie w wodzie i przykleić.
- CZ Nechte obtisk odmočit ve vodě a přilepte.
- HU Merítse vízbe és helyezze fel a matricát.
- SK Obtlačkový obrázok namočte do vody a priložte na plochu.
- NO Inmuiați abțibildul în apă și aplicați-l.
- BG Потопете ваденката във вода и я поставете.
- SI Preleperico namakajte v vodi. In namestite
- GR Μουσκεψτε σε νερό και τοποθετήστε τις χαλκομανίες.
- TR Çikartmayı suda yumuşatın ve takın.



- DE Zur Anbringung der Abziehbilder empfohlen.
- FR Recommended for affixing the decals.
- FR Recommandé pour l'application des décalcomanies.
- NL Aanbevolen voor het aanbrengen van de transfers.
- IT Raccomandato per l'applicazione delle decalcomanie.
- ES Recomendado para fijar bien las calcomanías.
- PT Recomendado para a fixação dos autocolantes.
- DK Anbefales til anbringelse af overførsbillederne.
- NO Anbefales til å feste avtrekksbilder.
- SE Rekommenderad för montering av klisterdekalerna.
- FI Suositellaan siirtokuvien siirtämiseen.
- RU Рекомендуется для нанесения переводных картинок.
- PL Zalecane do przyklejenia kalkomanii.
- CZ Doporučujeme k umístění obtiskovacích obrázků.
- HU A matrica felhelyezéséhez ajánlható.
- SK Odporúčame sa pre umiestnenie obtlačkových obrázkov.
- NO Recomandat pentru aplicarea abțibildurilor.
- BG Препоръчва се за поставяне на ваденки.
- SI Pri nameščanju nalepnic priporočamo.
- GR Συνιστάται για την τοποθέτηση των διάφανων μερών.
- TR Çikartmaların takılması için önerilir.



- DE Zur Anbringung der Klarteile empfohlen.
- FR Recommended to fix clear parts.
- FR Recommandé pour fixer les pièces transparentes.
- NL Aanbevolen voor het aanbrengen van transparante delen.
- IT Raccomandato per l'applicazione delle parti trasparenti.
- ES Recomendado para fijar las piezas transparentes.
- PT Recomendado para a aplicação das peças transparentes.
- DK Anbefales til anbringelse af de klare dele.
- NO Anbefales til å feste klare deler.
- SE Rekommenderad för montering av de genomskinliga detaljerna.
- FI Suositellaan läpinäkyvien osien siirtämiseen.
- RU Рекомендуется для крепления прозрачных деталей.
- PL Zalecane do przyklejenia przezroczystych części.
- CZ Doporučujeme k umístění průhledných dílů.
- HU Az átlátszó darabok felhelyezéséhez ajánlható.
- SK Odporúčame sa pre umiestnenie čírych dielov.
- NO Recomandat pentru aplicarea pieselor transparente.
- BG Препоръчва се за поставяне на прозрачни части.
- SI Pri nameščanju prozornih delov priporočamo.
- GR Συνιστάται για την τοποθέτηση των διάφανων μερών.
- TR Şeffaf parçaların takılması için önerilir.



- DE Nicht enthalten
- FR Not included
- FR Non fourni
- NL Behoort niet tot de levering
- IT Non incluso
- ES No incluido
- PT Não incluído
- DK Medfølger ikke
- NO Ikke inkludert
- SE Ingår ej
- FI Ei sisällä
- RU Не содержится
- PL Nie wchodzi w zakres dostawy
- CZ Není obsaženo
- HU Nem tartalmazza
- SK Neobsahuje
- NO Nu este inclus
- BG Не се включва в комплекта
- SI Ni priloženo
- GR Δεν περιλαμβάνεται
- TR İçermiyor

Benötigte Farben / Required colours

FR Peintures nécessaires
NL Benodigde kleuren
IT Colori necessari
ES Colores necesarios
PT Cores necessárias
DK Nødvendige farver
NO Nødvendige farger
SE Erforderliga färger
FI Tarvittavat värit
RU Необходимые краски
PL Potrzebne kolory
CZ Potřebné barvy
HU Szükséges színek
SK Požadované farby
RO Culori necesare
BG Необходими цветове
SI Potrebne barve
GR Απαιτούμενα χρώματα
TR Gerekli renkler

90% 49 **A** 56 10%

DE Hellblau matt
GB Light blue matt
FR Bleu ciel mat
NL Helblauw mat
IT Blu chiaro opaco
ES Azul claro mate
PT Azul claro mate
DK Lyseblå mat
NO Lyseblå matt
SE Ljusblå matt
FI Vaaleansininen matta
RU Голубой матовый
PL Jasnyniebieski matowy
CZ Světlá modrá matný
HU Világoskék, fénytelen
SK Svetlo modrá matný
RO Albastru-deschis mat
BG Светлосиньо матово
SI Svetlo-modra mat
GR Γαλάζιο ανοιχτό ματ
TR Açık mavi mat

DE Blau matt
GB Blue matt
FR Bleu mat
NL Blauw mat
IT Blu opaco
ES Azul mate
PT Azul mate
DK Blå mat
NO Blå matt
SE Blå matt
FI Sininen matta
RU Синий матовый
PL Niebieski matowy
CZ Modrá matný
HU Kék, fénytelen
SK Modrá matný
RO Albastru mat
BG Синьо матово
SI Modra mat
GR Μπλε ματ
TR Mavi mat

302 **B**

DE Schwarz seidenmatt
GB Black silk matt
FR Noir satiné mat
NL Zwart zijdemat
IT Nero opaco satinato
ES Negro mate satinado
PT Preto mate sedoso
DK Sort silkematt
NO Sort silkematt
SE Svart sidenmatt
FI Musta silkimatta
RU Чёрный шелковисто-матовый
PL Czarny jedwabiscie matowy
CZ Černá jemně matný
HU Fekete, fakóselymes
SK Čierna hodvábne matný
RO Negru satinat
BG Черно коприненоматово
SI Črna svilenlo-mat
GR Μαύρο σατινέ
TR Siyah ipeksi mat

99 **C**

DE Aluminium metallic
GB Aluminium metallic
FR Aluminium métallique
NL Aluminium metallic
IT Alluminio metallico
ES Aluminio metálico
PT Aluminio metálico
DK Aluminium metallisk
NO Aluminium metallic
SE Aluminium metallic
FI Alumiini metallinen
RU Алюминий металлик
PL Aluminium metaliczny
CZ Hliníková metalizový
HU Alumínium metál
SK Hliníková metalíza
RO Aluminiiu metalic
BG Алюминий металлик
SI Aluminijasta kovinska
GR Αλουμίνιο μεταλλικό
TR Alüminyum grisi metalik

06 **D**

DE Teerschwarz matt
GB Tar black matt
FR Noir goudron mat
NL Teerzwart mat
IT Nero catrame opaco
ES Negro breia mate
PT Preto alcitrão mate
DK Tjæresort mat
NO Tjæresort matt
SE Tjärsvart matt
FI Tervanmusta matta
RU Битумно-чёрный матовый
PL Czarna smoła matowy
CZ Dehtová černá matný
HU Kátrányfekete, fénytelen
SK Čierna térová matný
RO Negru-închis mat
BG Катранено черно матово
SI Katransko-črna mat
GR Μαύρο βαθύ ματ
TR Katran siyahı mat

77 **E**

DE Staubgrau matt
GB Dusty grey matt
FR Gris poussièrè mat
NL Stofgrijs mat
IT Grigio polvere opaco
ES Gris polvo mate
PT Cinza pó mate
DK Støvet grå mat
NO Støvgrå matt
SE Dammgrå matt
FI Tomunharmaa matta
RU Серая пыль матовый
PL Szary stalowy matowy
CZ Prachová šed matný
HU Porszürke, fénytelen
SK Prachovo sivá matný
RO Gri prafulit mat
BG Прашносиво матово
SI Prašno-siva mat
GR Σταχτί ματ
TR Duman grisi mat

07 **F**

DE Schwarz glänzend
GB Black gloss
FR Noir brillant
NL Zwart glanzend
IT Nero lucido
ES Negro brillante
PT Preto brilhante
DK Sort blank
NO Sort glansende
SE Svart blank
FI Musta kiiltävä
RU Чёрный глянцевый
PL Czarny błyszczący
CZ Černá lesklý
HU Fekete, fényes
SK Čierna lesklý
RO Negru-strălucitor
BG Черно гланцово
SI Črna sijoča
GR Μαύρο γυαλιστερό
TR Siyah parlak

50% 302 **G** 378 50%

DE Schwarz seidenmatt
GB Black silk matt
FR Noir satiné mat
NL Zwart zijdemat
IT Nero opaco satinato
ES Negro mate satinado
PT Preto mate sedoso
DK Sort silkematt
NO Sort silkematt
SE Svart sidenmatt
FI Musta silkimatta
RU Чёрный шелковисто-матовый
PL Czarny jedwabiscie matowy
CZ Černá jemně matný
HU Fekete, fakóselymes
SK Čierna hodvábne matný
RO Negru satinat
BG Черно коприненоматово
SI Črna svilenlo-mat
GR Μαύρο σατινέ
TR Siyah ipeksi mat

DE Dunkelgrau seidenmatt
GB Dark grey silk matt
FR Gris foncé satiné mat
NL Donkergrijs zijdemat
IT Grigio scuro opaco satinato
ES Gris oscuro mate satinado
PT Cinza escuro mate sedoso
DK Mørkegrå silkematt
NO Mørk grå silkematt
SE Mörkgrå sidenmatt
FI Tummanharmaa silkimatta
RU Тёмно-серый шелковисто-матовый
PL Ciemnoszary jedwabiscie matowy
CZ Tmavá šedá jemně matný
HU Sötétszürke, fakóselymes
SK Tmavo sivá hodvábne matný
RO Gri-închis satinat
BG Тъмносиво коприненоматово
SI Temno-siva svilenlo-mat
GR Γκρι σκούρο σατινέ
TR Koyu gri ipeksi mat

332 **H**

DE Leuchtröt seidenmatt
GB Luminous red silk matt
FR Rouge voyant satiné mat
NL Neonrood zijdemat
IT Rosso luminoso opaco satinato
ES Rojo luminoso mate satinado
PT Vermelho fluorescente mate sedoso
DK Lysende rød silkematt
NO Selvlýsende rød silkematt
SE Lysande röd sidenmatt
FI Hohtava punainen silkimatta
RU Ярко-красный шелковисто-матовый
PL Świetlisty czerwony jedwabiscie matowy
CZ Červená svítící jemně matný
HU Világító piros, fakóselymes
SK Svetielkujúca červená hodvábne matný
RO Roșu luminos satinat
BG Светещо червено коприненоматово
SI Svetlo-rdeča svilenlo-mat
GR Κόκκινο φωτεινό σατινέ
TR Palak kırmızı ipeksi mat

378 **I**

DE Dunkelgrau seidenmatt
GB Dark grey silk matt
FR Gris foncé satiné mat
NL Donkergrijs zijdemat
IT Grigio scuro opaco satinato
ES Gris oscuro mate satinado
PT Cinza escuro mate sedoso
DK Mørkegrå silkematt
NO Mørk grå silkematt
SE Mörkgrå sidenmatt
FI Tummanharmaa silkimatta
RU Тёмно-серый шелковисто-матовый
PL Ciemnoszary jedwabiscie matowy
CZ Tmavá šedá jemně matný
HU Sötétszürke, fakóselymes
SK Tmavo sivá hodvábne matný
RO Gri-închis satinat
BG Тъмносиво коприненоматово
SI Temno-siva svilenlo-mat
GR Γκρι σκούρο σατινέ
TR Koyu gri ipeksi mat



DE Beispiel: mischen
GB Example: mixing
FR Exemple: mélanger
NL Voorbeeld: mengen
IT Esempio: mescolare
ES Ejemplo: mezclar
PT Exemplo: misturar
DK Eksempel: blanding
NO Eksempel: blanding
SE Exempel: blanda
FI Esimerkki: sekoittaminen

RU Пример: смешивание
PL Przykład: mieszac
CZ Příklad: míchání
HU Példa: keverés
SK Příklad: miešanie
RO Exemplu: amestecare
BG Пример: смесване
SI Primer: mešanje
GR Παράδειγμα: ανάμειξη
TR Örnek: karıştırma

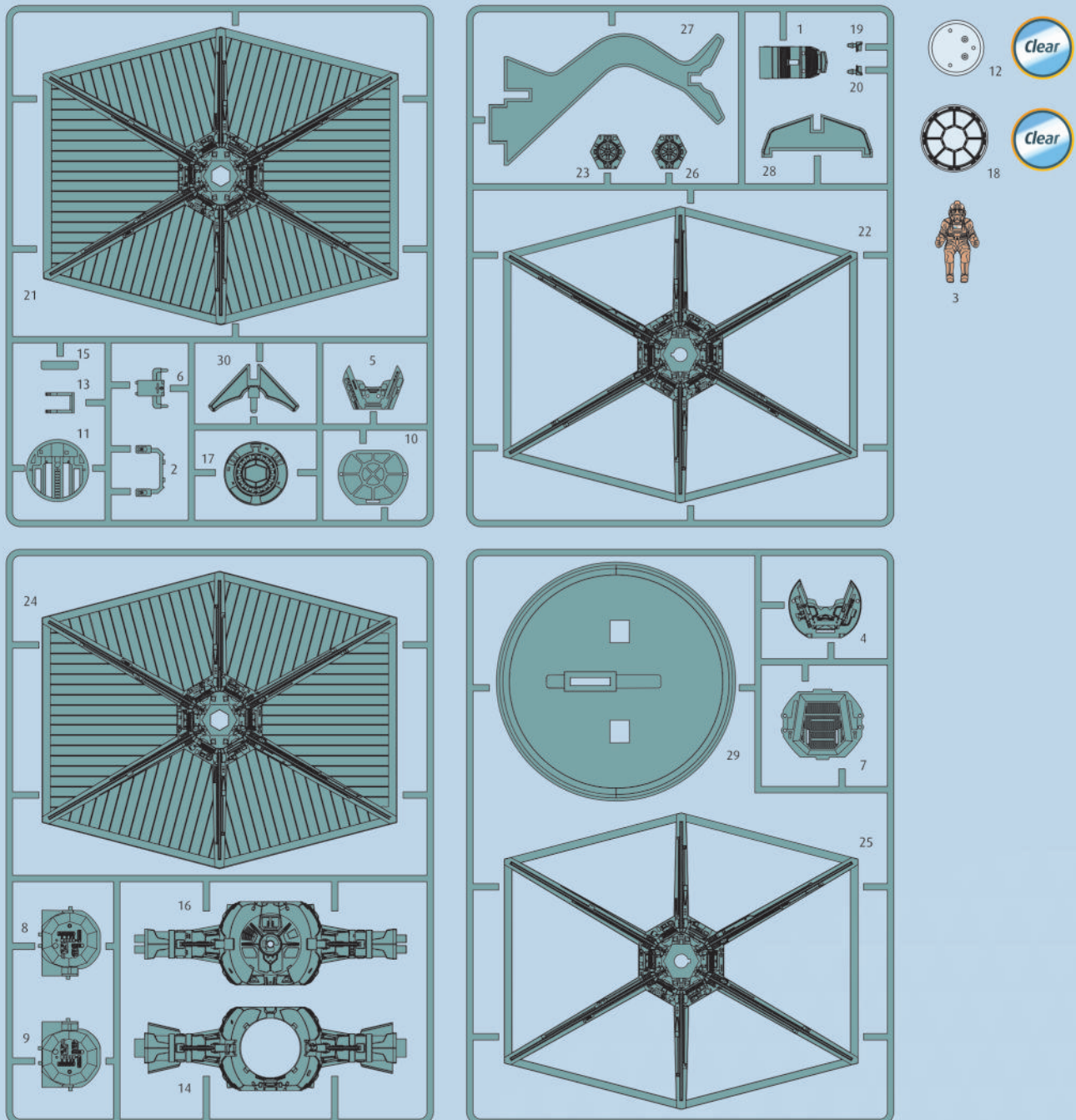

Ersatzteile benötigt?

Kein Problem. Einfach den Revell-Service mit Angabe von Artikel- und Teilenummer kontaktieren. Entweder unter service@revell.de oder Revell GmbH, Abteilung X, Henschelstr. 20-30, 32257 Bünde.*

*Wir bitten um Verständnis, dass eine Gewährleistung nur bei aktuellen Artikeln, die im Zeitraum der letzten 24 Monate erworben wurden, übernommen werden kann. Mit der Ersatzteil-Bestellung können Kosten z.B. für Verpackung und Versand entstehen. Ob diese Kosten anfallen wird im Vorfeld schriftlich durch unseren Service mitgeteilt. Das Angebot kann dann angenommen oder abgelehnt werden. Unfrei eingesandte Ersatzteil-Bestellungen werden von uns nicht angenommen! Dieser Direktservice gilt für die Länder Deutschland, Benelux, Österreich, Frankreich, Großbritannien. Ersatzteil-Bestellungen aus den übrigen Ländern werden über die jeweiligen Distributeure abgewickelt. Bitte kontaktieren Sie Ihren Händler.

Besoin de pièces de rechange ?

Il vous suffit de contacter le service Revell et d'indiquer la référence de l'article et de la pièce. Soit en écrivant par mail à service@revell.de (uniquement pour la France) ou par courrier à Revell GmbH, Département X, Henschelstr. 20-30, D-32257 Bünde.*

*La garantie s'applique pour les articles présents au catalogue et achetés au cours des 24 derniers mois. Merci de votre compréhension. La commande de pièces de rechange peut donner lieu à des frais supplémentaires, par ex. pour l'emballage et le port. Notre service client vous en informera au préalable par écrit. Vous pourrez accepter ou refuser le devis. Nous n'acceptons pas les commandes de pièces de rechange envoyées sans affranchissement ! Ce service direct est valable pour les pays suivants : Allemagne, Benelux, Autriche, France, Grande-Bretagne. Les commandes de pièces en provenance d'autres pays sont traitées par les distributeurs correspondants. Veuillez contacter votre revendeur.

Need spare parts?

No problem. Contact Revell Service with the item number and part numbers you need: service@revell.de or Revell GmbH, Unit 10, Old Airfield Industrial Estate, Cheddington Lane, Tring, Herts, HP23 4QR, Great Britain.*

*We request your understanding that a warranty can only be accepted for current articles which have been purchased in the last 24 months. Orders for spare parts may also be subject to costs for packaging and shipping. You will be notified in advance by our Service department if such costs are incurred. The offer can then be accepted or rejected. We will not be able to process any postal requests unless correct postage has been applied to mailing! This direct service applies to the countries: Germany, Benelux, Austria, France, and the United Kingdom. Spare part orders from other countries are processed by the local distributors. Please contact your dealer.

Hebt u reserveonderdelen nodig?

Geen probleem! Neem eenvoudig contact op met de klantenservice van Revell en geef ons het artikel- en onderdeelnummer door. U kunt ons bereiken op service@revell.de of per post: Revell GmbH, Afdeling X, Henschelstr. 20-30, 32257 Bünde.*

*Wij vragen uw begrip voor de omstandigheid, dat er alleen garantie kan worden geboden voor actuele artikelen, die in de afgelopen 24 maanden zijn gekocht. Met het bestellen van reserveonderdelen kunnen kosten gemoeid zijn, bijv. voor verpakking en verzending. U wordt vooraf schriftelijk door onze klantenservice op de hoogte gesteld als er kosten zouden ontstaan. Het aanbod kan dan worden aangenomen of afgewezen. Wij nemen geen ongefrankeerde bestellingen van reserveonderdelen aan! Deze rechtstreekse service wordt verleend in de landen Duitsland, de Benelux, Oostenrijk, Frankrijk en Groot-Brittannië. Bestellingen van reserveonderdelen in de overige landen worden afgewikkeld via de betreffende distributeurs. Neem hiervoor contact op met uw verkoper.

1

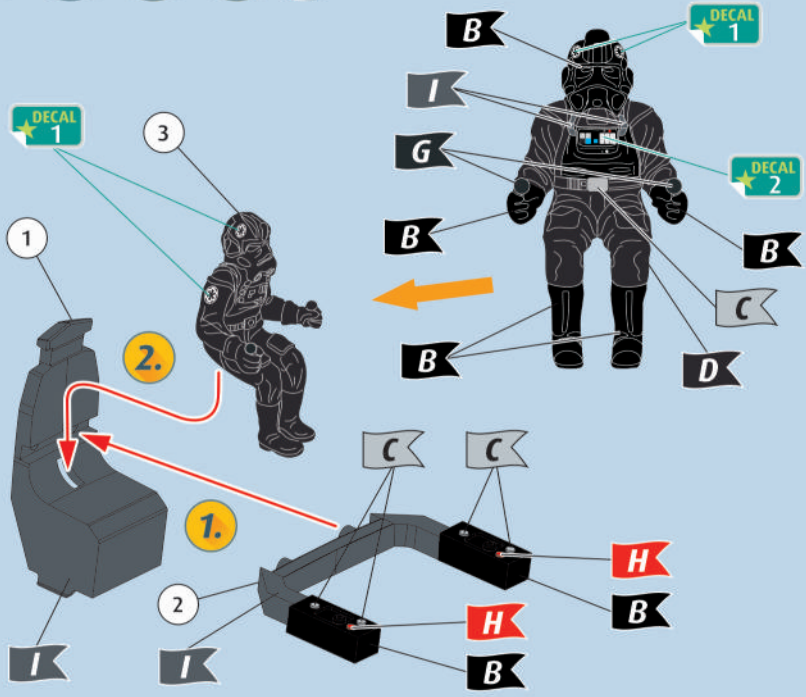

2

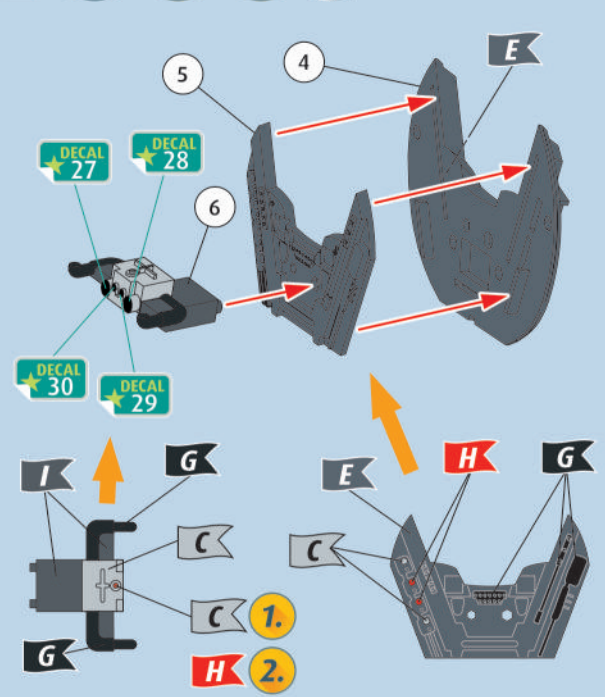

3

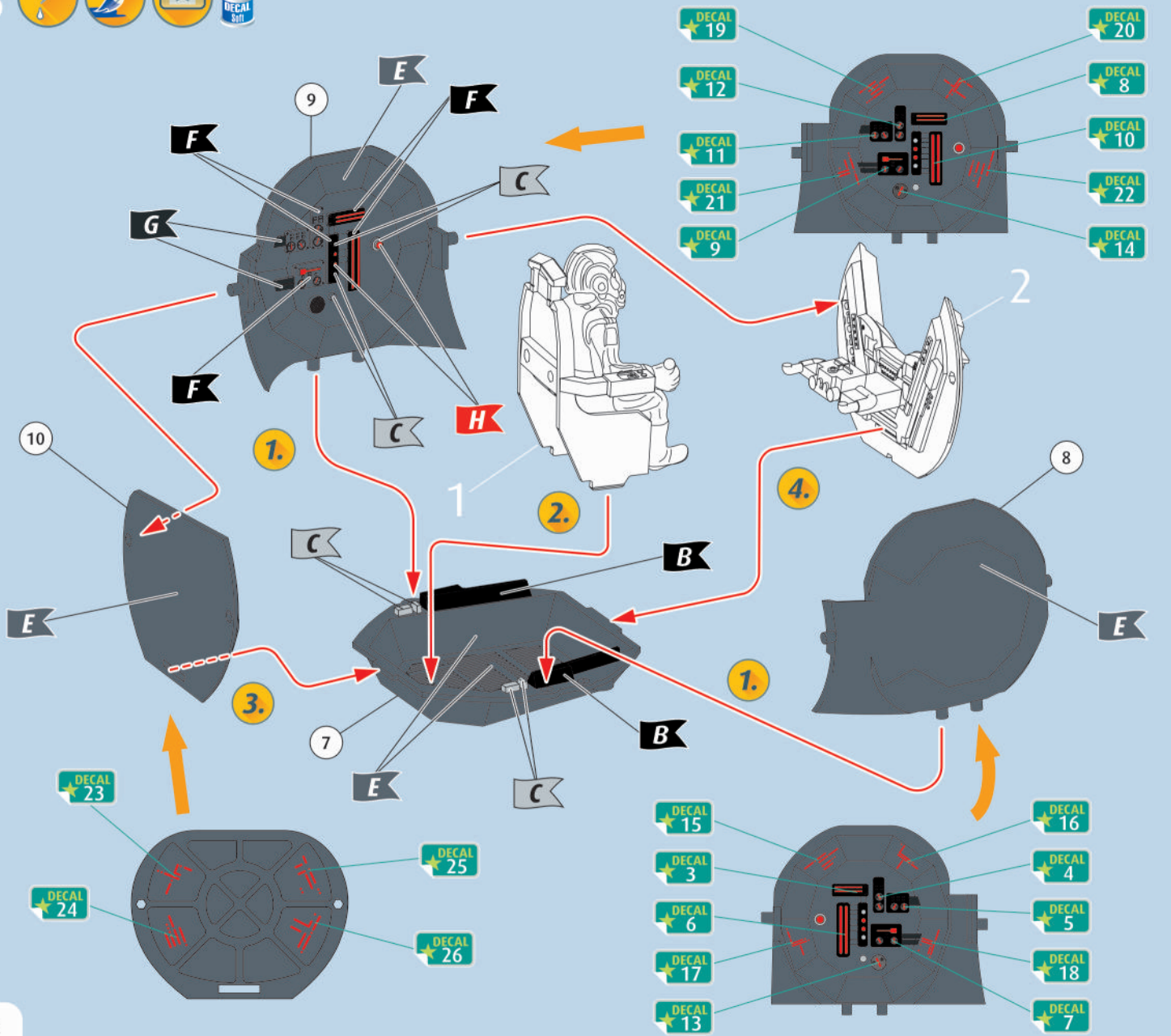

4

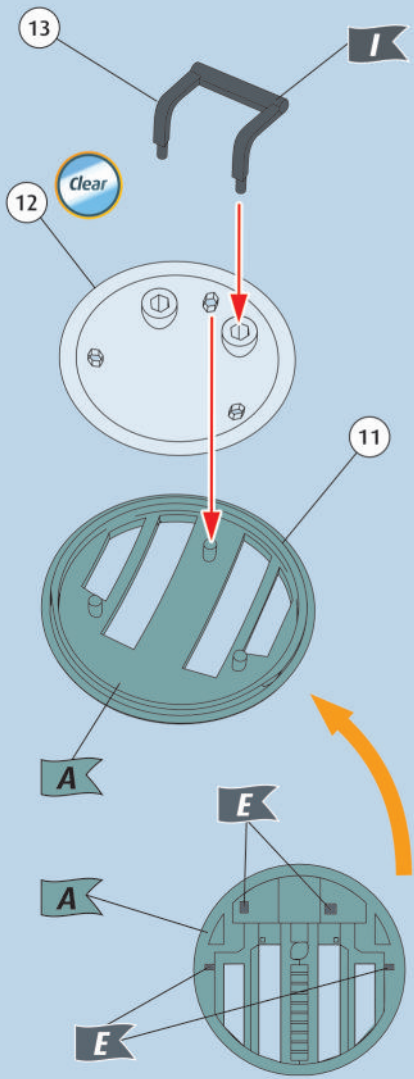

5

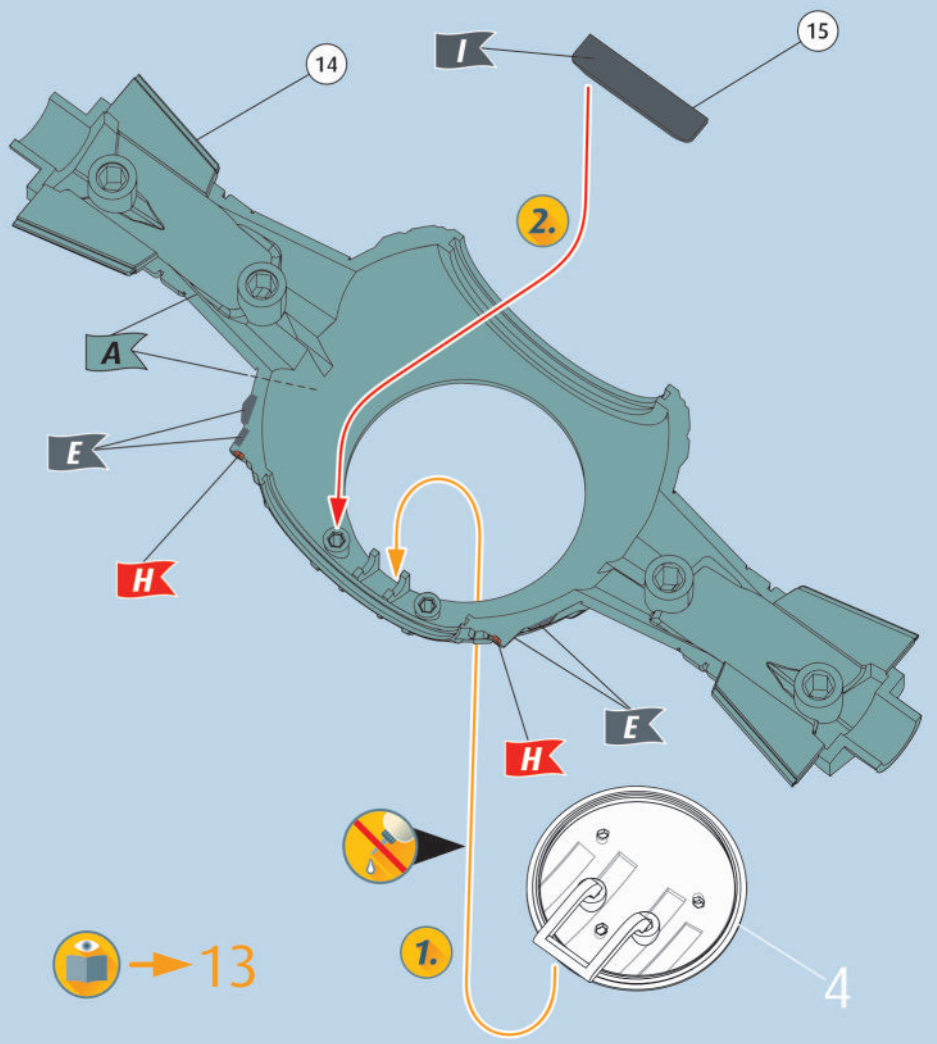

6

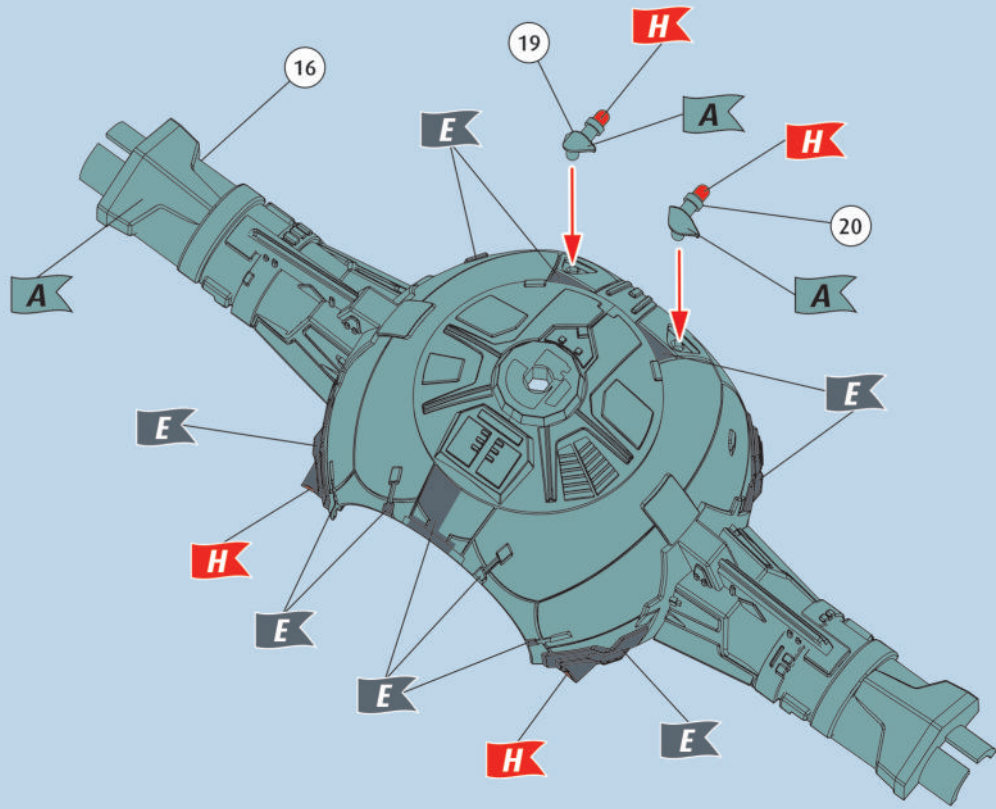

7

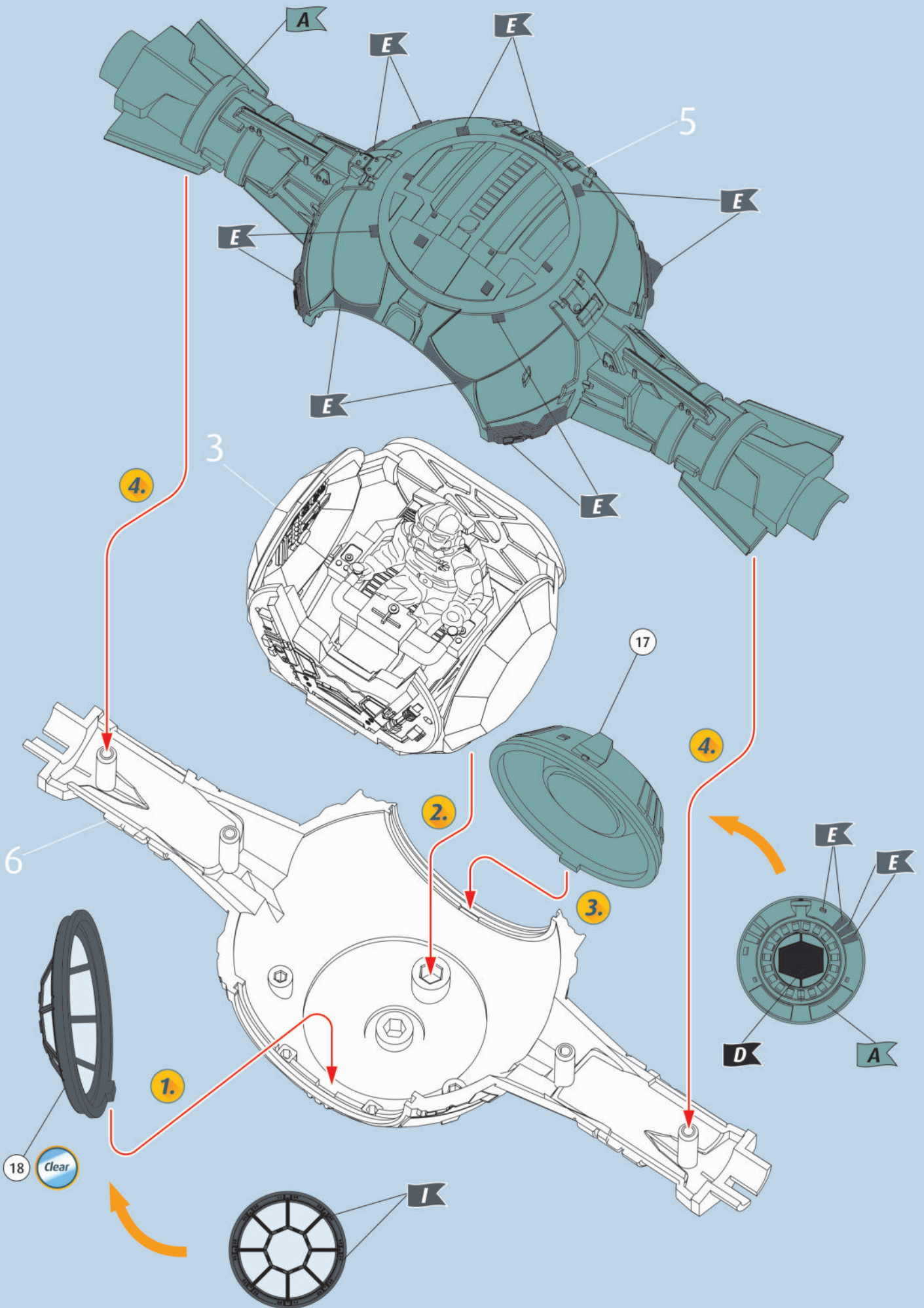

8  

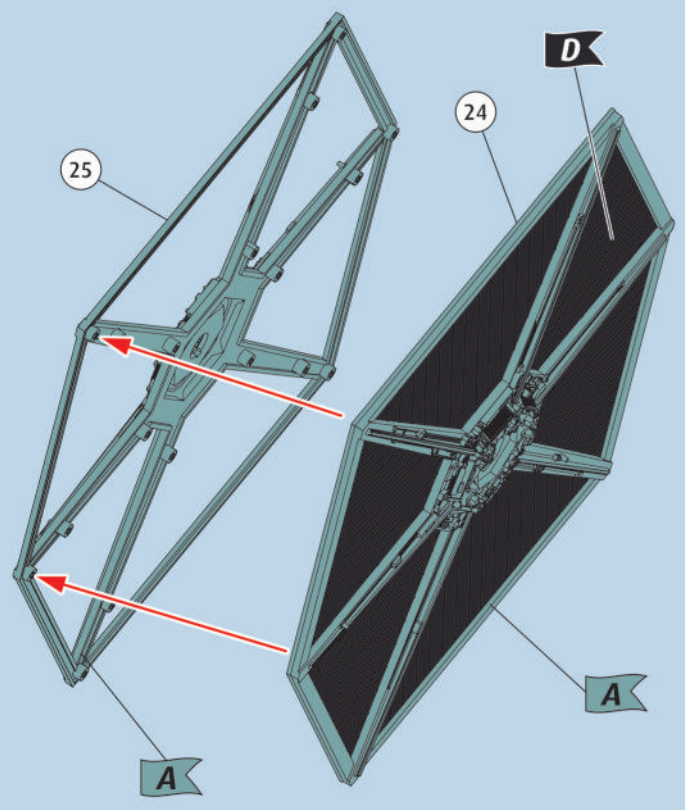

9  

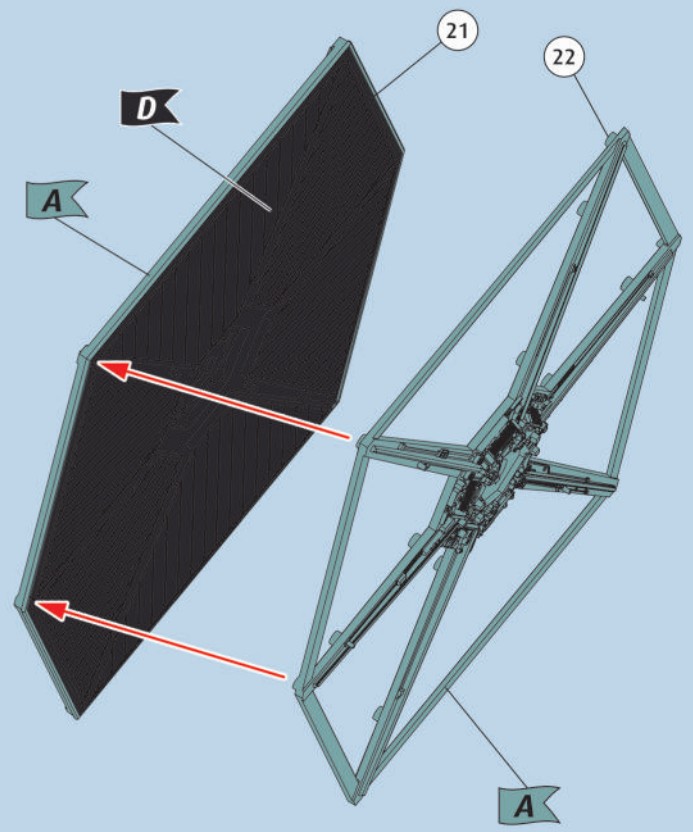

10  

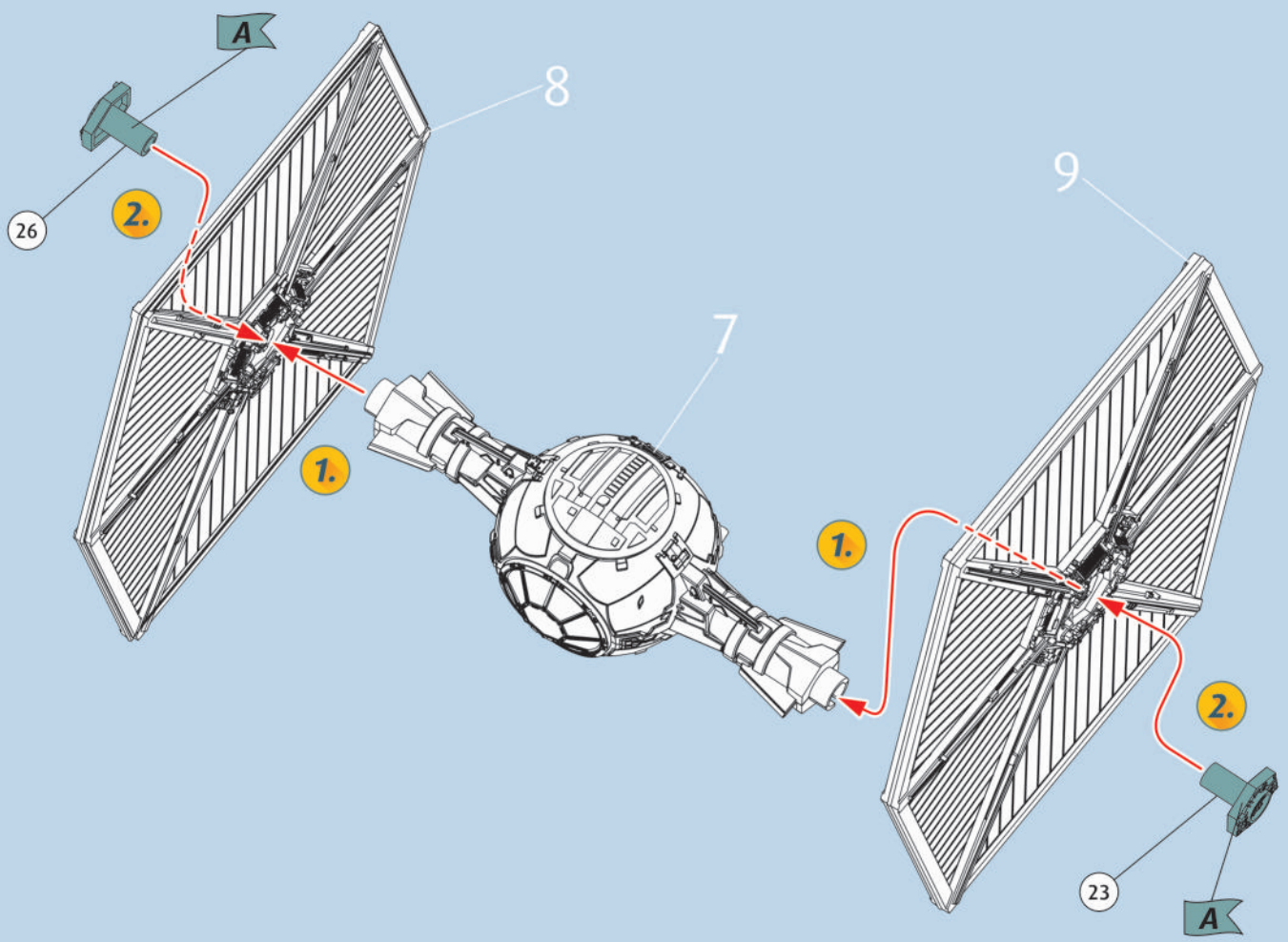

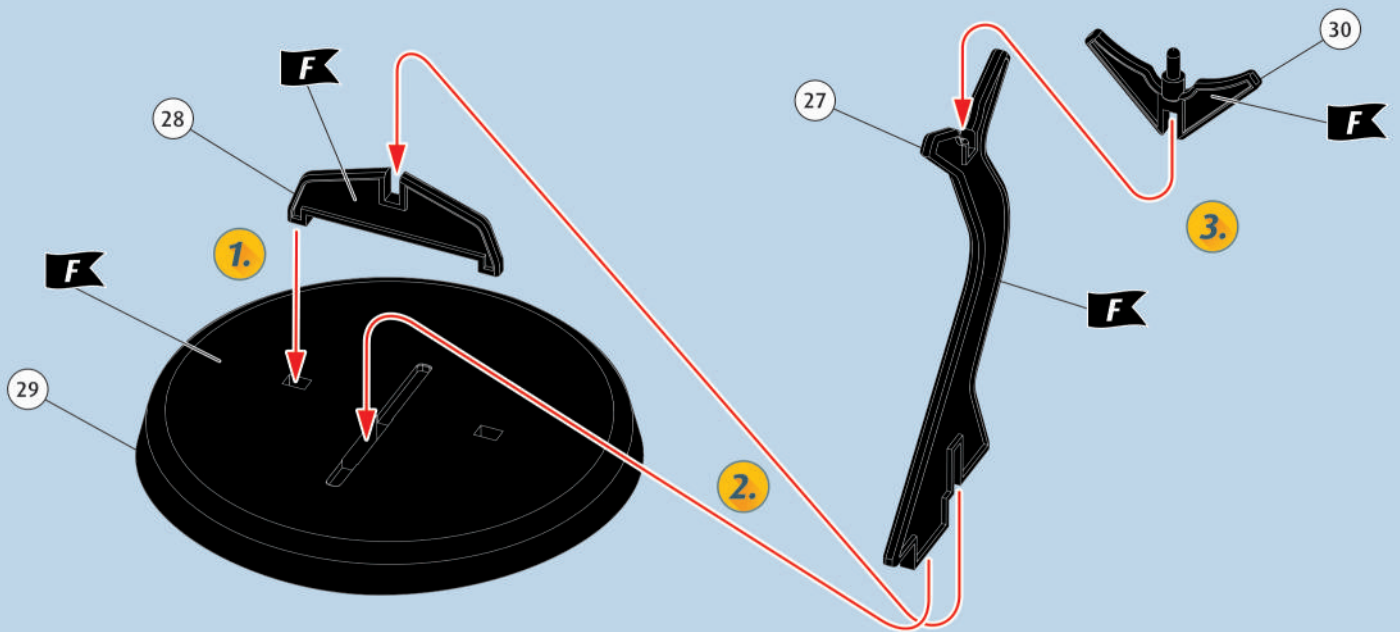
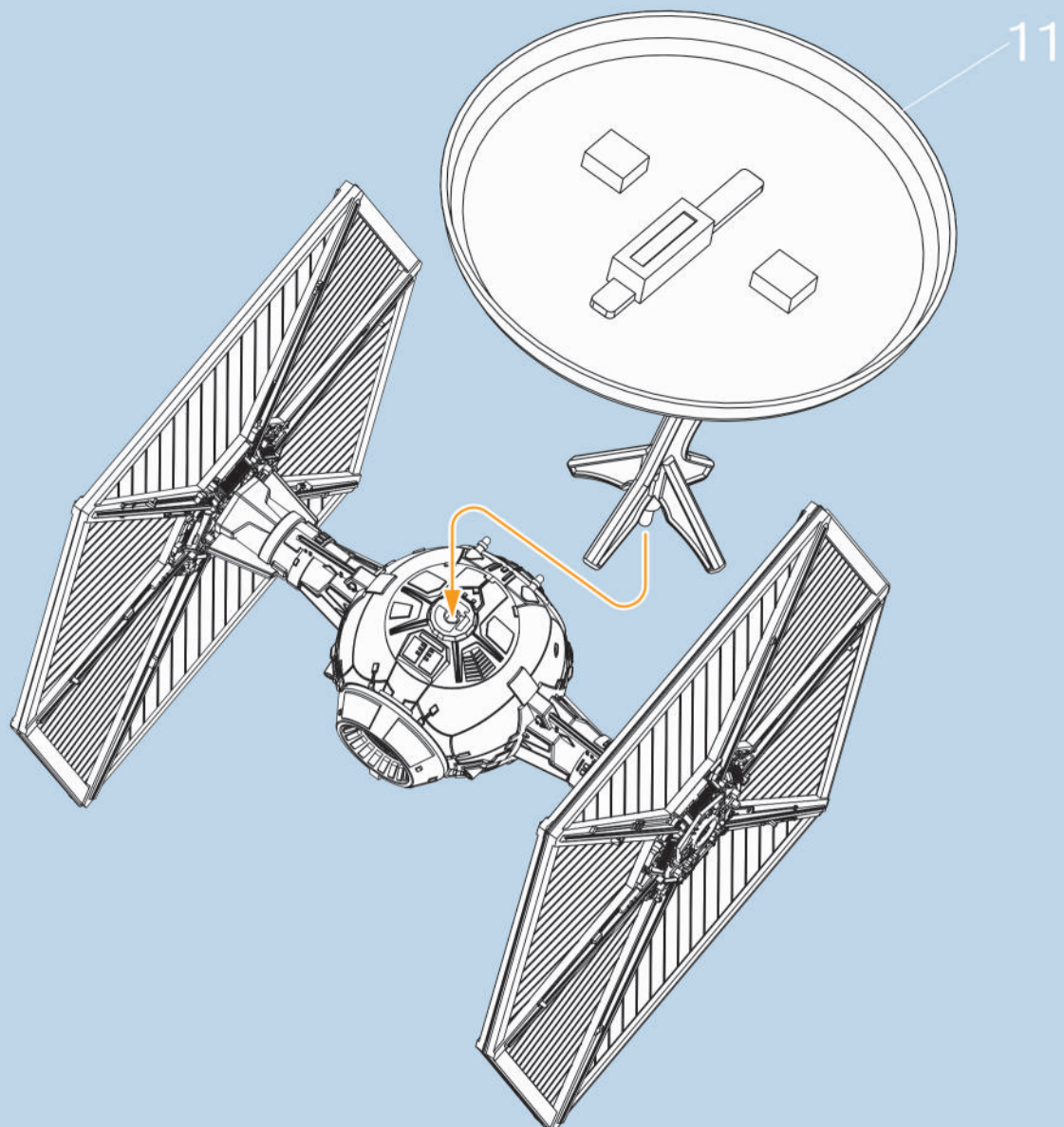
11  12 

A

D

E

F

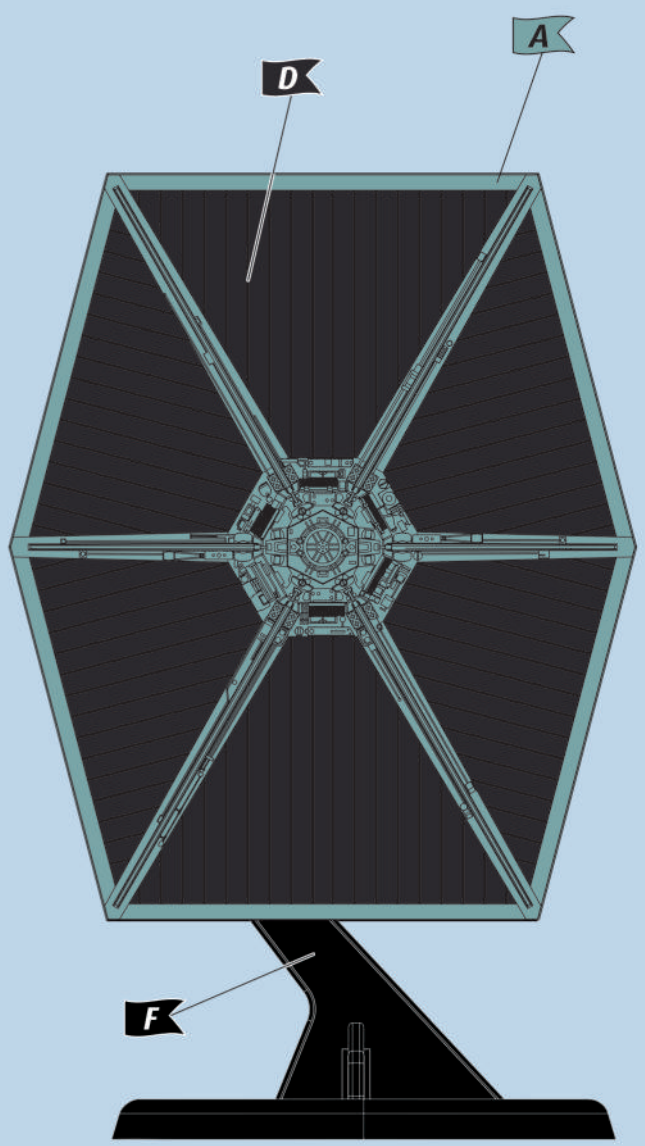
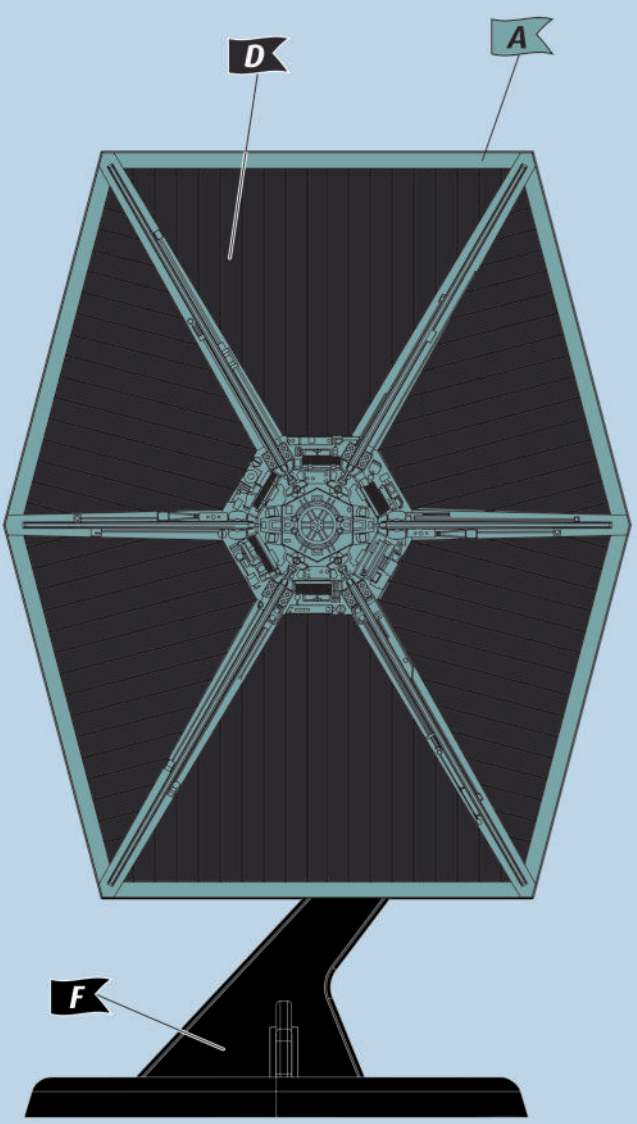
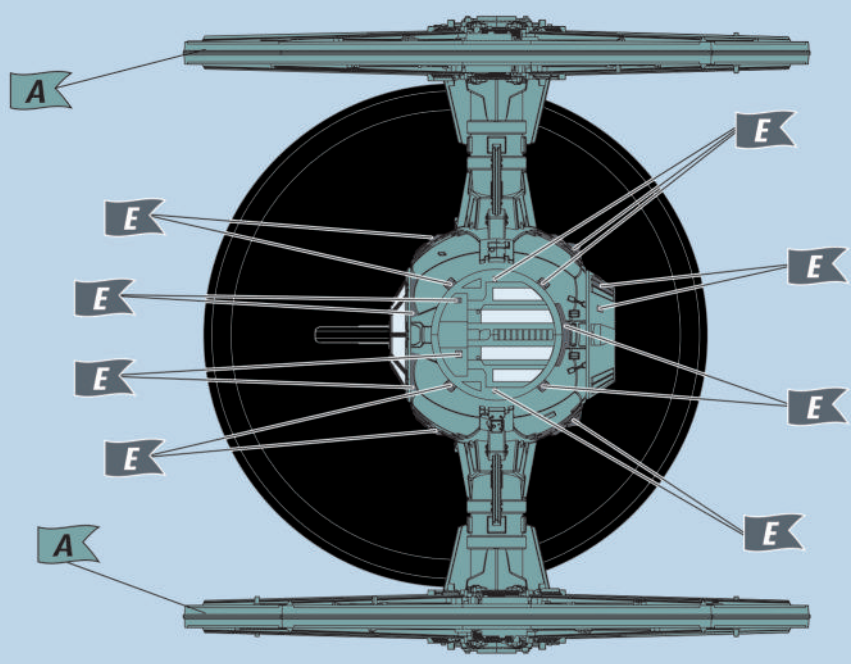

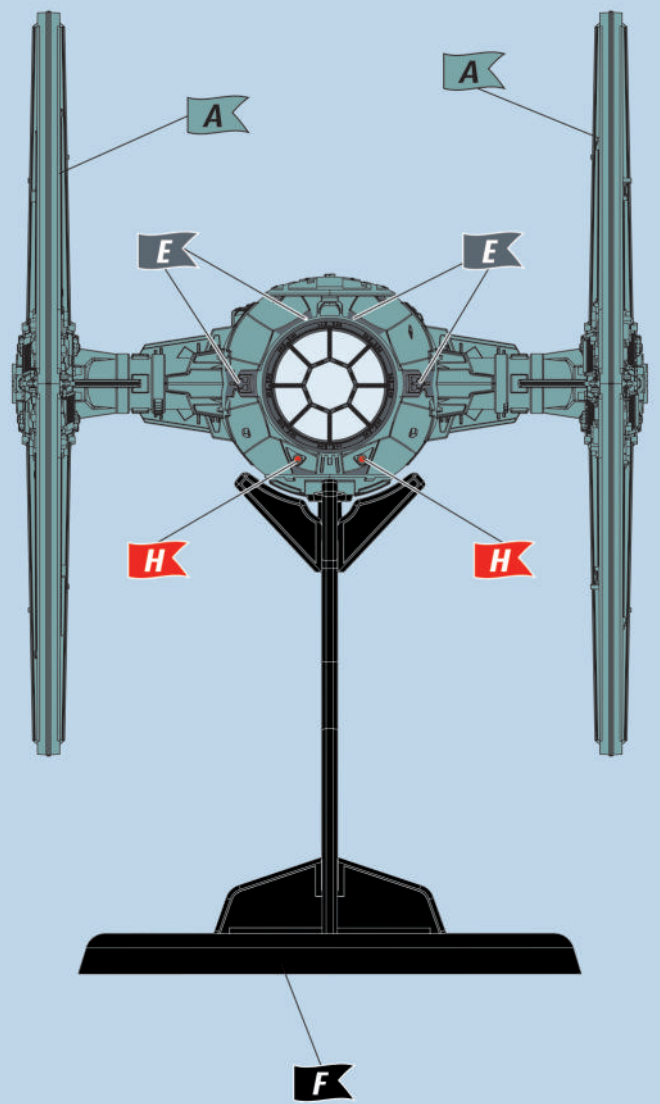
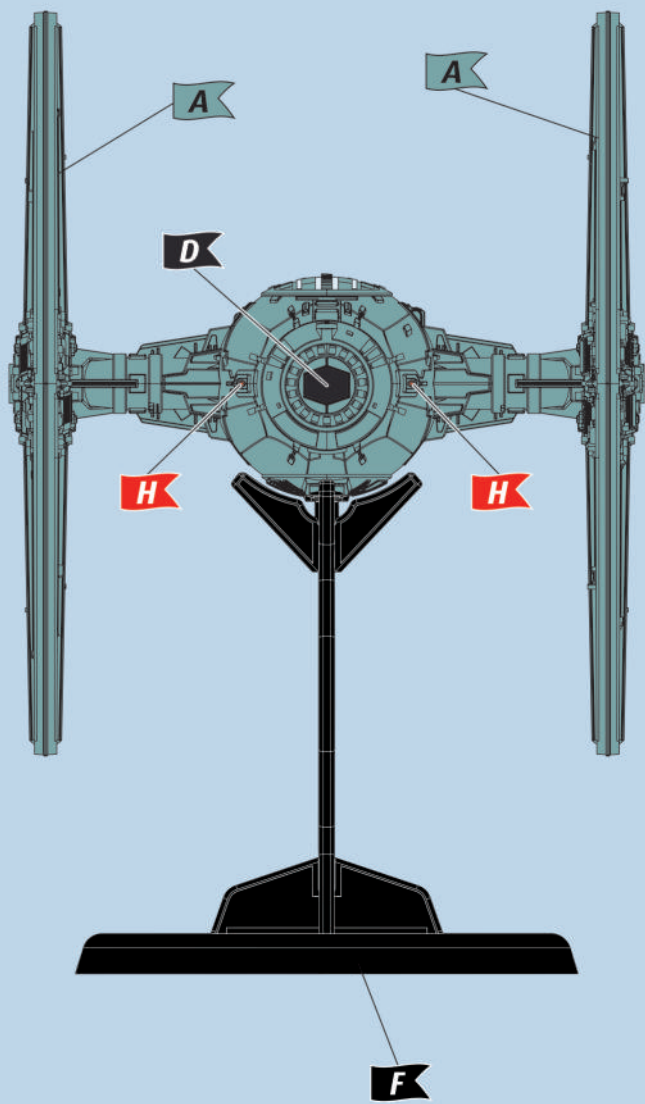

A

D

E

F

H