

ACHTUNG! Dieses Produkt enthält kleine sowie scharfkantige Metallteile. Arbeiten Sie sorgfältig in gut gelüfteten und hell beleuchteten Räumen.

Schutzbrillen werden empfohlen.

Behandlungshinweise: 1. Die Teile auf einem harten Untergrund mit einem scharfen Bastelmesser (evtl. Nagelschere) vom Rahmen abtrennen. 2. Die Schnittstellen mit einer feinen Feile säubern. 3. Teile vor der Verarbeitung in einer milden Seifenlauge spülen. 4. Wenn notwendig die Teile gemäß Anleitung mit einer kleinen Flachzange biegen. 5. Die Teile mit einer feinen Spritzpistole oder einem feinen Pinsel lackieren. 6. Der Sekundenkleber sollte in ganz geringen Mengen mit einem Zahnstocher aufgebracht werden.

Am besten Revell CONTACTA QUICK Sekunden-Kleber verwenden. Wir empfehlen Revell-Farben der Serie EMAIL COLOR und AQUA COLOR.

WARNING! This product contains small and sharp parts. Work carefully in a ventilated and well-lit room. Safety glasses are recommended.

Instructions: 1. Separate the parts from the frame with a sharp craft knife (or nail scissors) on a hard surface. 2. Trim the cut edges with a fine file. 3. Rinse the parts in mild soapy water before working with them. 4. If necessary bend the parts with a small pair of flat nosed pliers as shown in the drawings. 5. Paint the parts with a fine spray gun or a fine brush. 6. The quick-drying glue should be applied in minute quantities with a toothpick.

Please use Revell CONTACTA QUICK quick-drying glue. We recommend Revell paints from the EMAIL COLOR and AQUA COLOR series.

ATTENTION! Cet article contient des pièces petites ou coupantes. Travaillez avec soin, dans une pièce bien aérée et bien éclairée. Les lunettes protectrices sont recommandées.

Instructions: 1. Pour séparer les pièces de la grappe, les appuyer sur un support résistant et les sectionner avec une lame tranchante (ou éventuellement une pince à ongles). 2. Soigner les points de coupe avec une lime douce. 3. Avant de les mettre en place, laver les pièces avec une savonnée diluée. 4. Si les instructions l'indiquent, plier les pièces avec précaution avec une petite pince plate. 5. Peindre les pièces avec un aérographe ou un pinceau fin. 6. Appliquer la colle instantanée en petite quantité à l'aide d'un cure-dents en bois.

Utiliser de référence la colle à séchage rapide CONTACTA QUICK. Nous recommandons l'utilisation des peintures des séries EMAIL COLOR et AQUA COLOR.

¡ADVERTENCIA! Este producto contiene piezas pequeñas y puntiagudas. Trabaje con cuidado en una habitación ventilada y bien iluminada. Se recomienda el uso de gafas de seguridad.

Modo de empleo: 1. Para separar las piezas, apoyarlas en un soporte resistente, y cortar con una cuchilla afilada (o con alicates). 2. Pulir las cortas con una lima dulce. 3. Antes del montaje, limpiar las piezas con agua de jabón. 4. Cuando falta, plegar con pinzas planas siguiendo las instrucciones. 5. Pintar con un aerógrafo o con un pincel fino. 6. Aplicar cantidades mínimas de cola instantánea con un mondadientes de madera.

Utilice pegamento de secado rápido Revell CONTACTA QUICK. Recomendamos pinturas Revell de las gamas EMAIL COLOR Y AQUA COLOR.

PE01

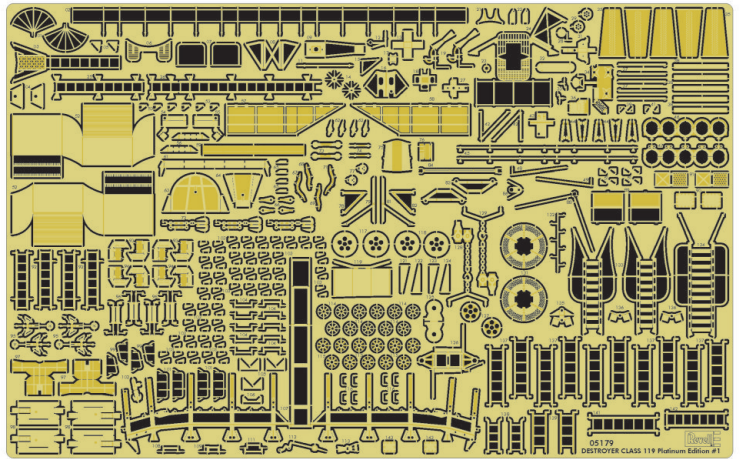

PE02

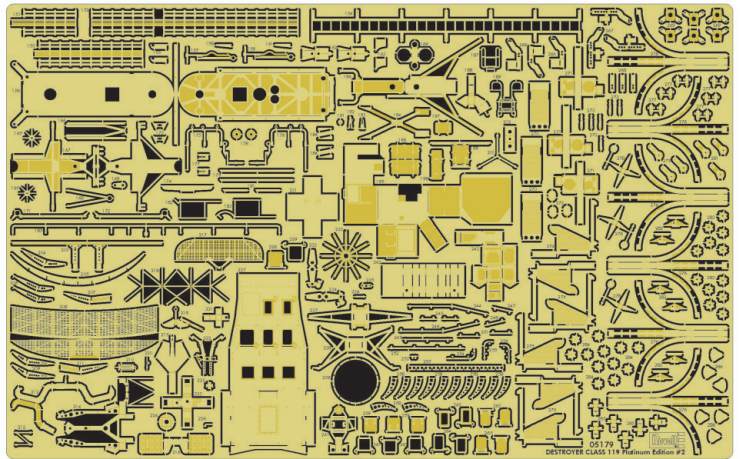

PE03

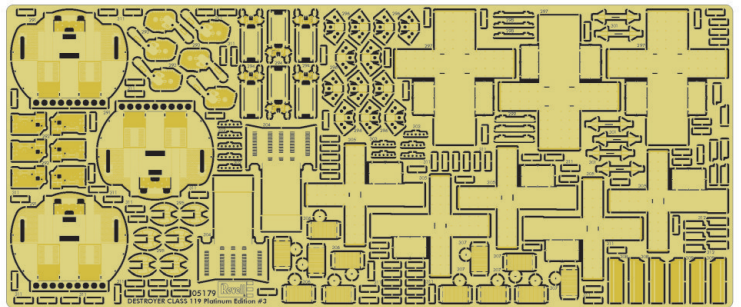

PE04

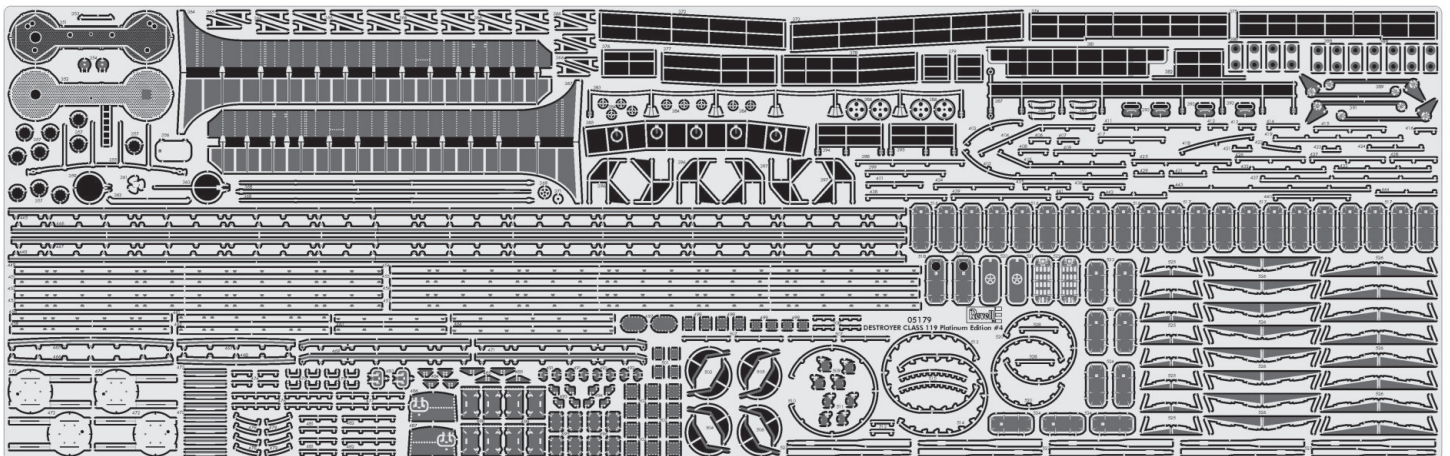

Chain

- BR01 5inch Barrel : 4X
- BR02 3inch Barrel : 6X
- BR03 Mast Base : 1X
- BR04 Yard : 1X
- BR05 Top Mast A+B : 1X
- BR06 Top Mast C : 2X
- BR07 Mast : 1X
- BR08 Mast Sturt A : 2X
- BR09 Mast Sturt B : 2X
- BR10 Yard Arm : 2X
- BR11 Signal Beacon : 2X
- BR12 UPX-5 Antenna : 1X
- BR13 AN/SPS-6 Radar Axis : 1X
- BR14 AN/SPS-10 A+B : 1X
- BR15 MK.37 Gun Director A : 1X
- BR16 MK.37 Gun Director B : 1X
- BR17 MK.37 Gun Director C : 1X
- BR18 MK.37 Gun Director D : 1X
- BR19 Reel : 2X
- BR20 Jack Staff 1 : 1X
- BR21 Ensign Staff A : 1X
- BR22 Ensign Staff B : 1X
- BR23 Decoy Reel A : 1X
- BR24 Decoy Reel B : 1X
- BR25 Rail A : 2X
- BR26 Rail B : 2X
- BR27 Capstan : 1X
- BR28 Loop Antenna Axis : 1X
- BR29 MK56 Director A+B+C : 1X
- BR30 Torpedo Director A+B+C : 1X
- BR31 Siren A+Brake Wheel Axis B +Light CX2+Light DX5 : 1X
- BR32 Whistle : 1X
- BR33 AS-570/SLR Antenna : 1X
- BR34 AS-571 Antenna : 1X
- BR35 Whip Antenna Base : 3X
- BR36 AS-390 Antenna : 1X
- BR37 10inch Bitt : 22X
- BR38 Depth Charge A : 11X
- BR39 Depth Charge B : 7X

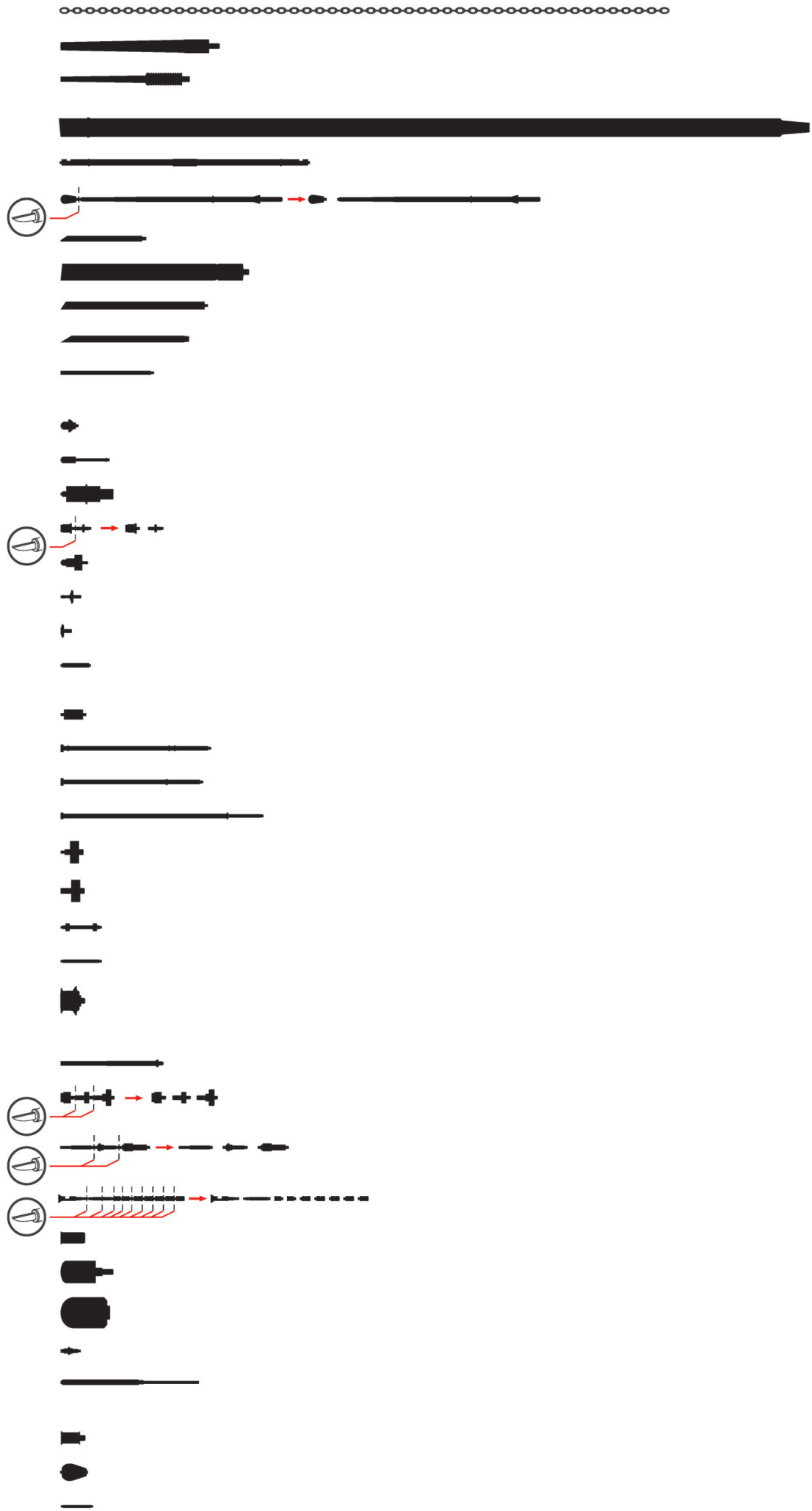

01

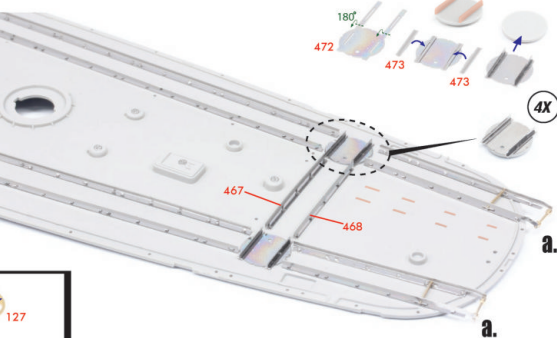
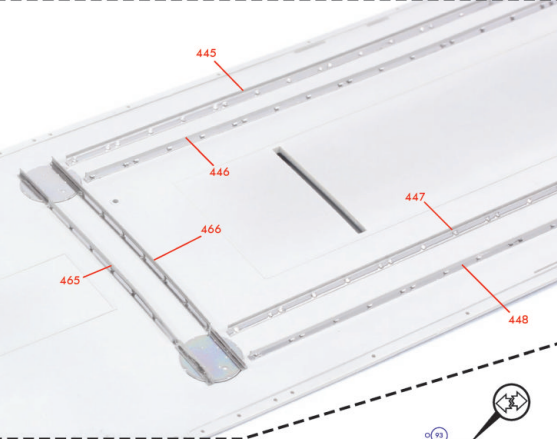
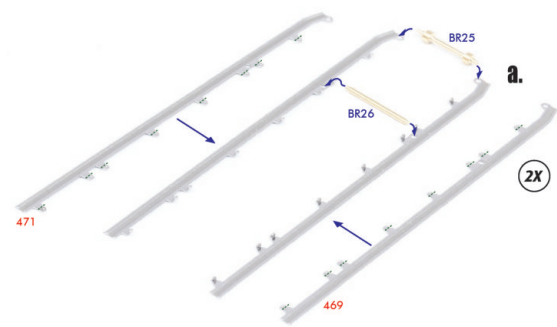
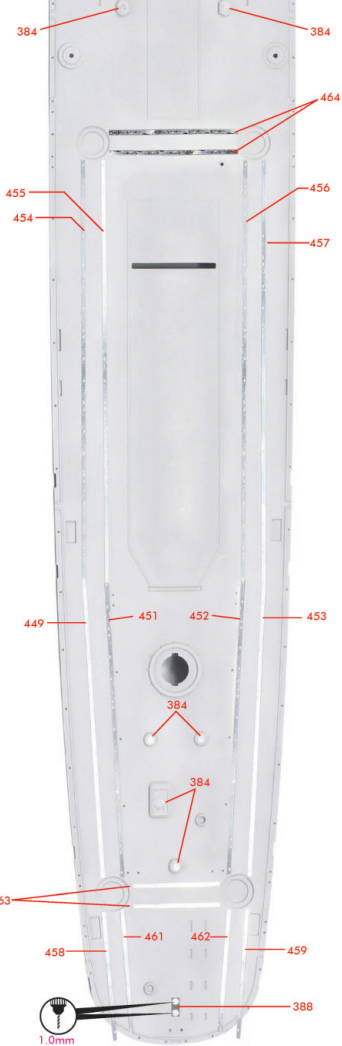
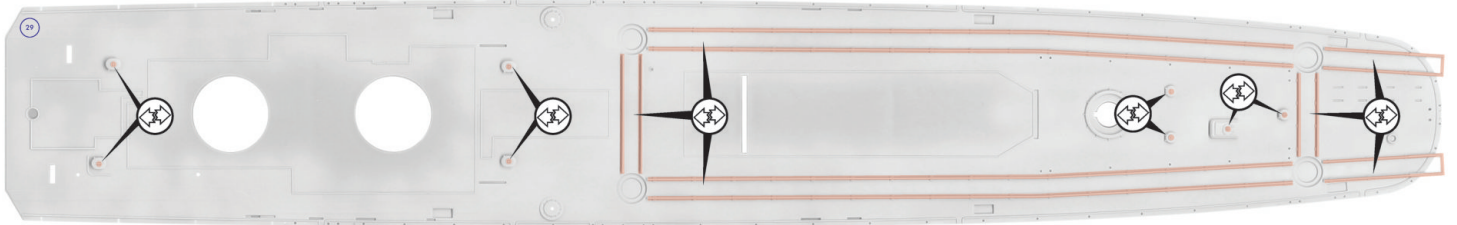

04

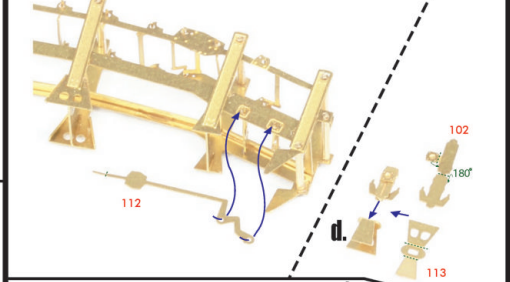
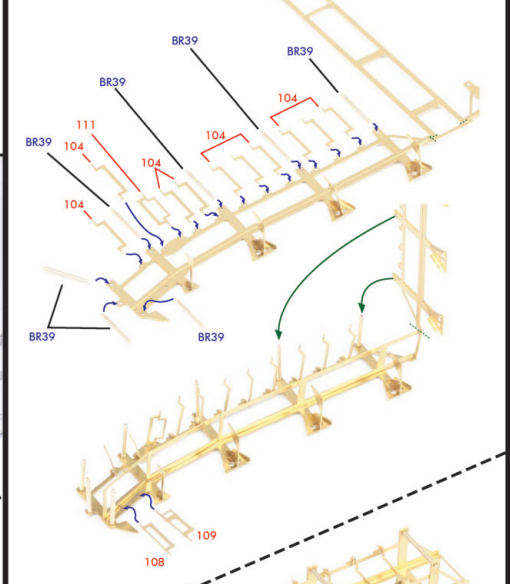
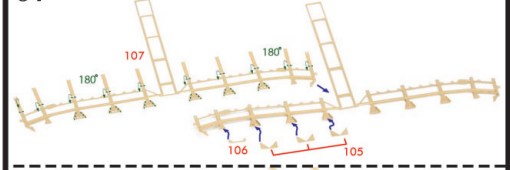

02

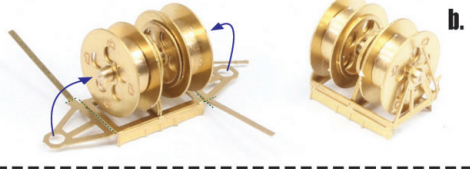
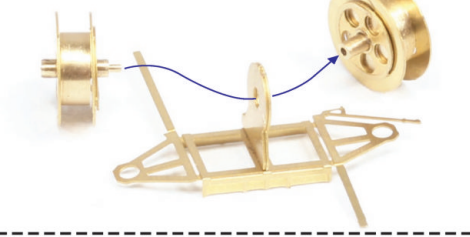
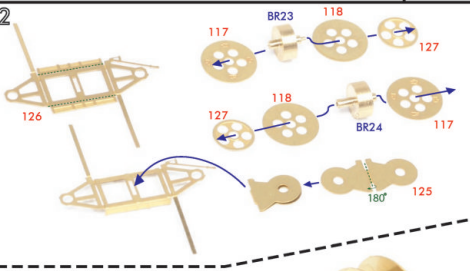

03

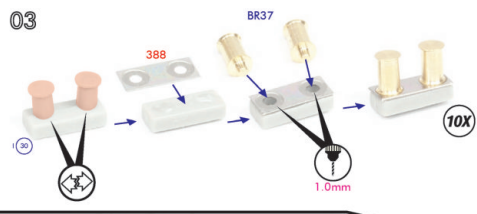

05

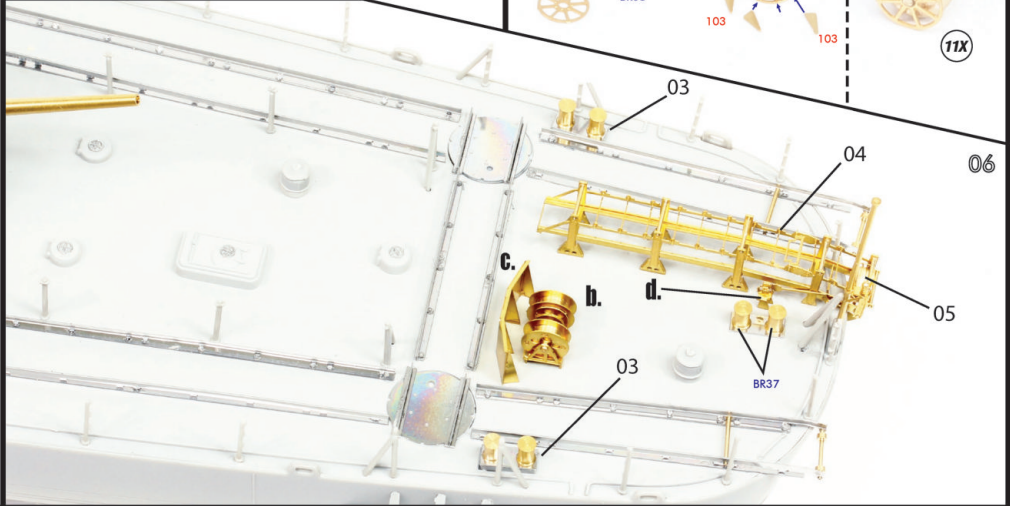
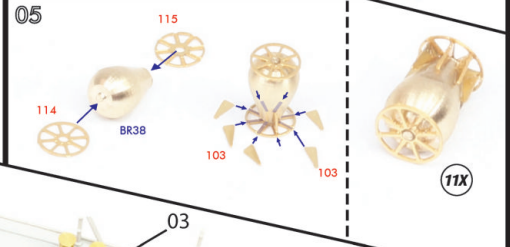

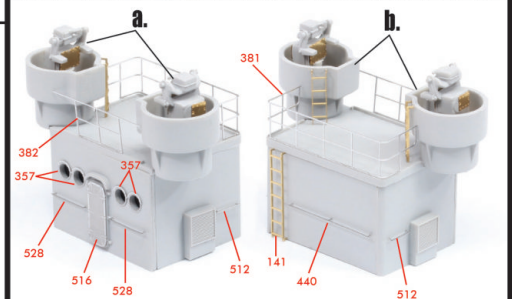
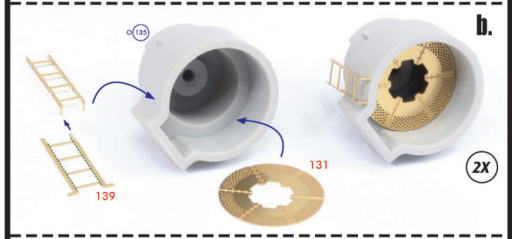
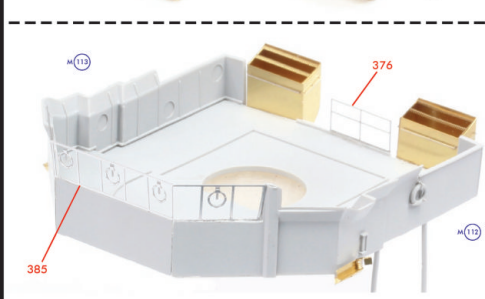
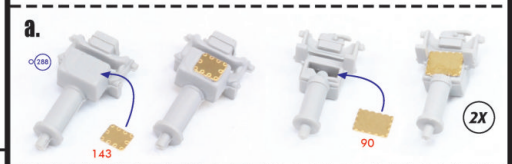
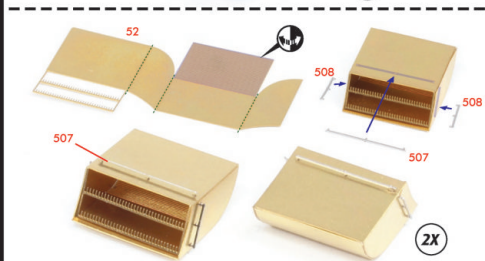
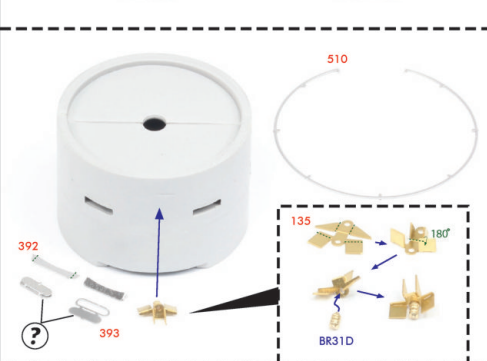
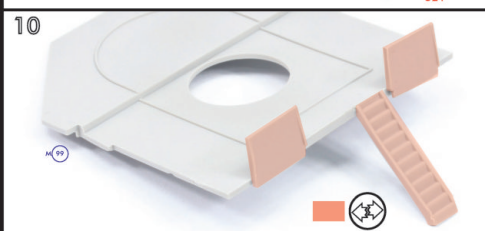
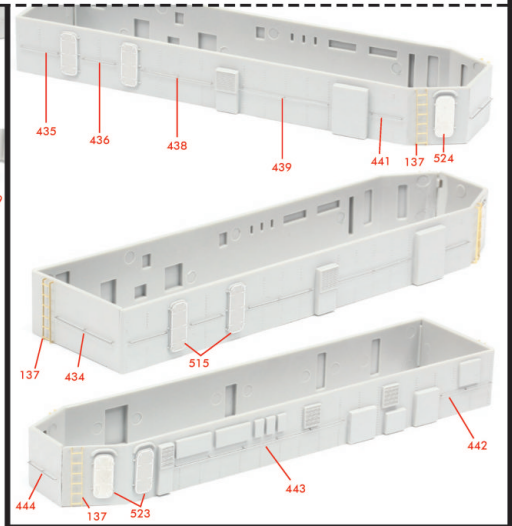
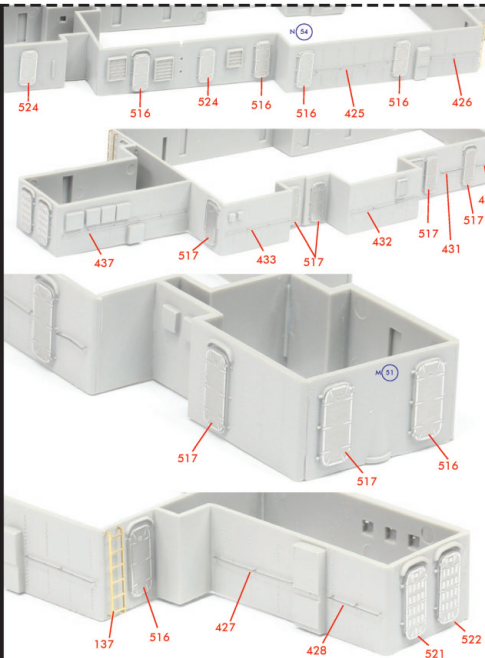
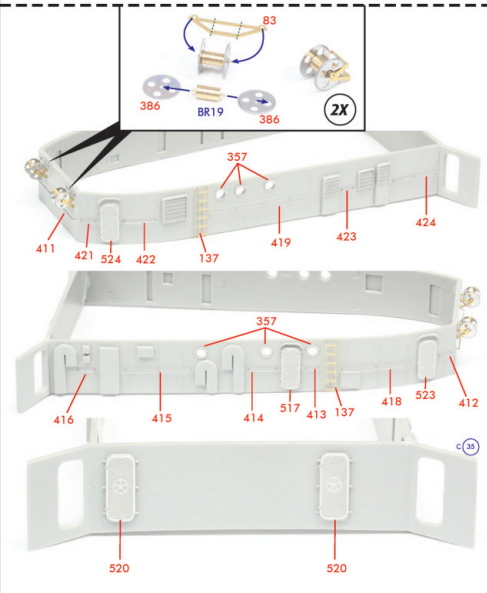
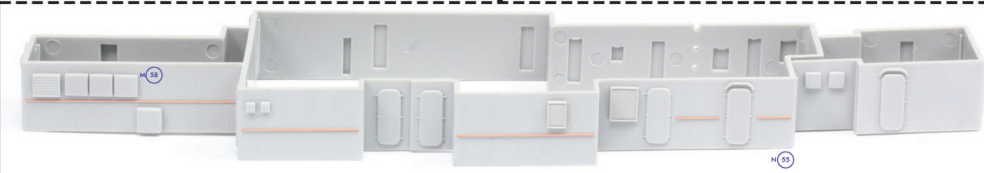
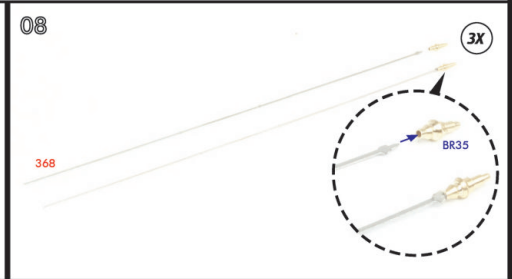
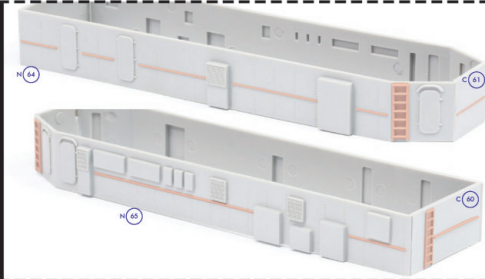
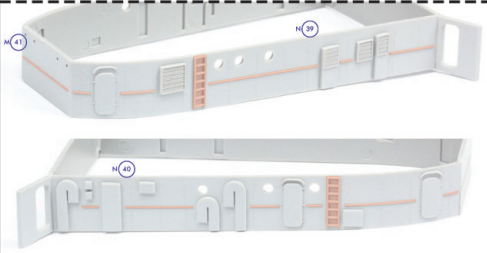
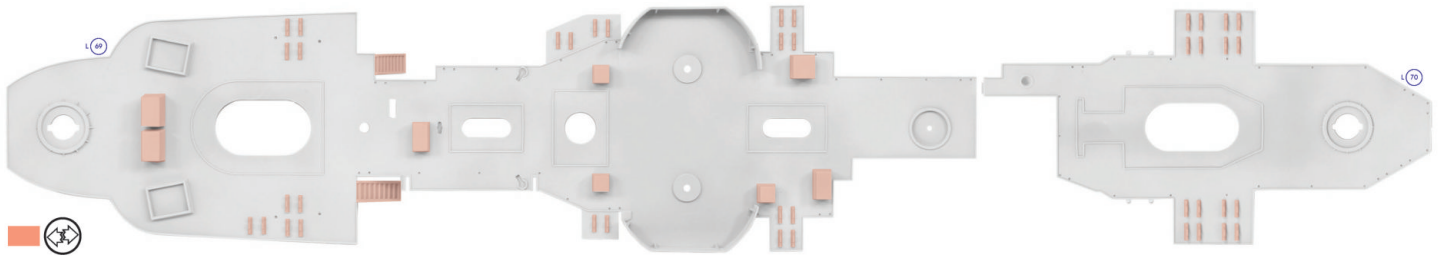

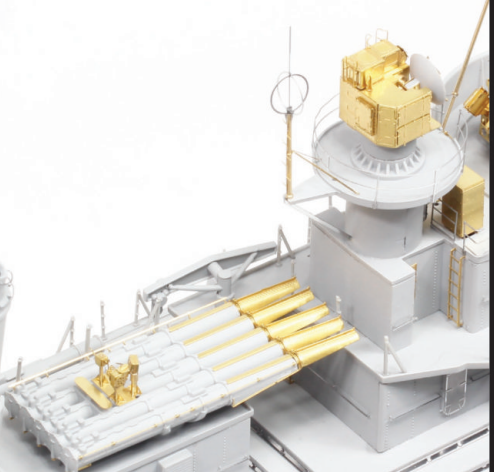
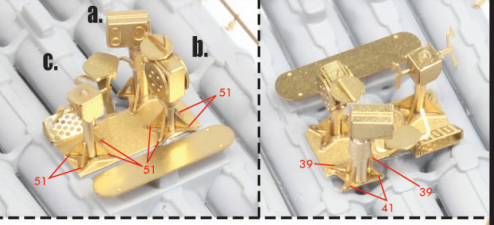
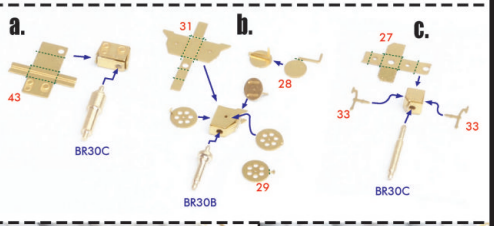
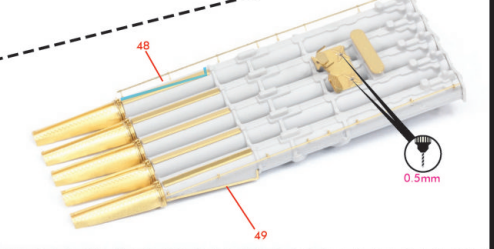
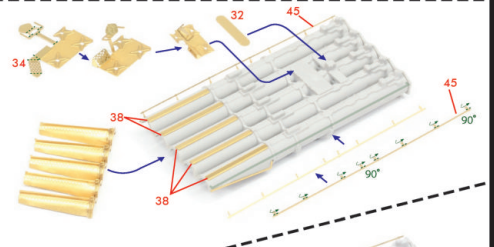
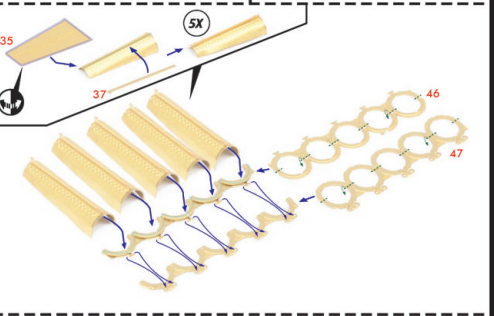
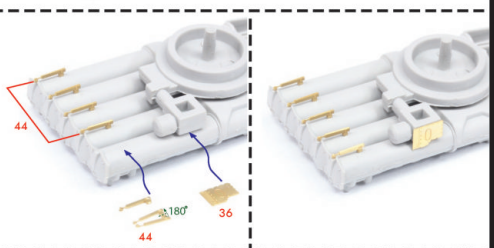
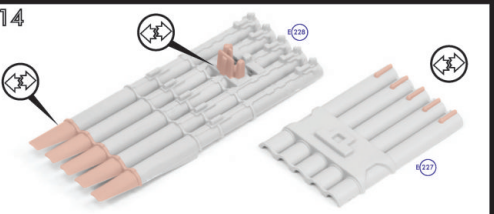
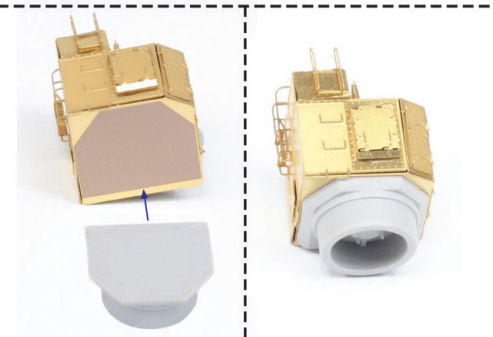
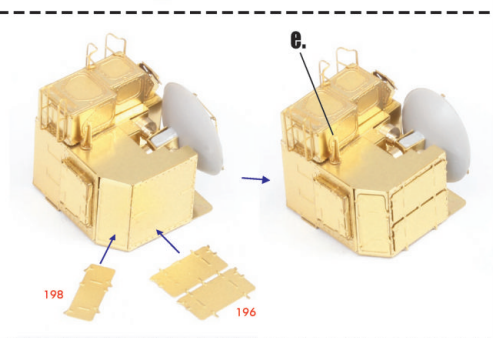
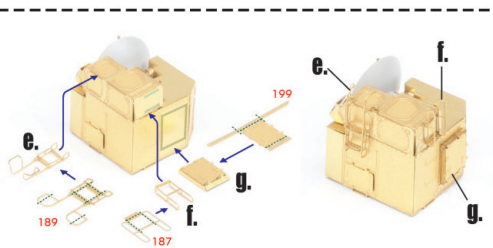
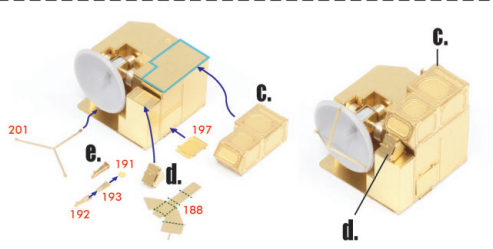
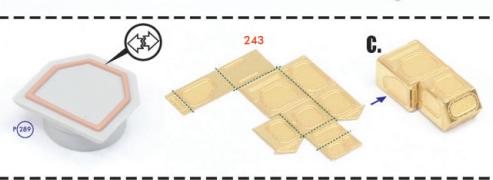
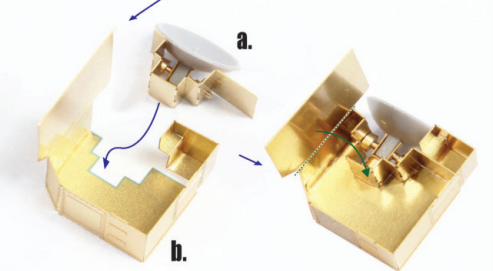
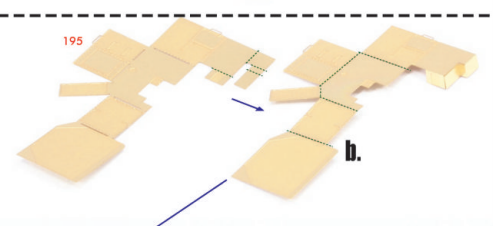
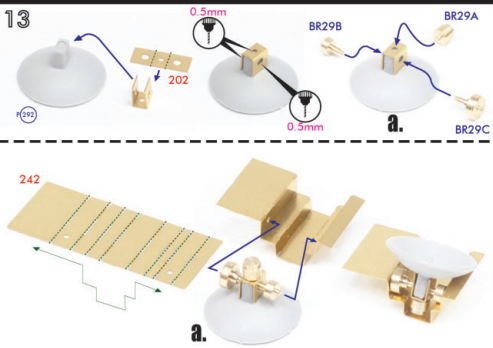
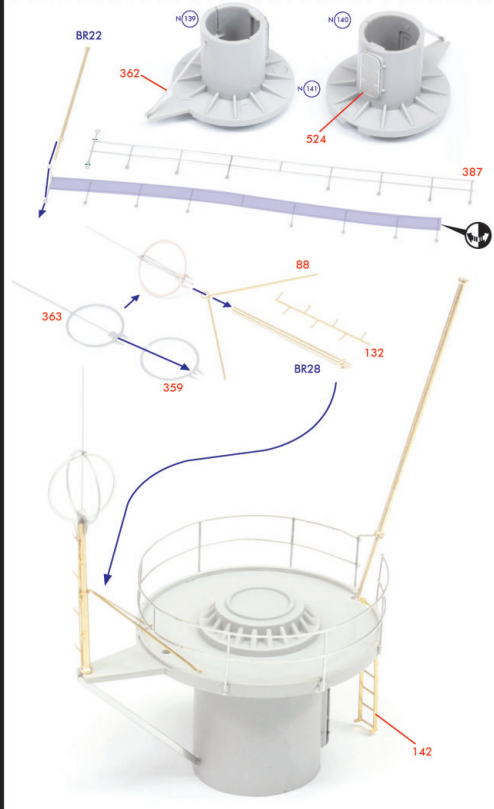
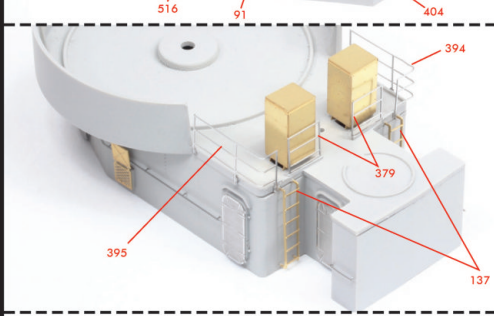
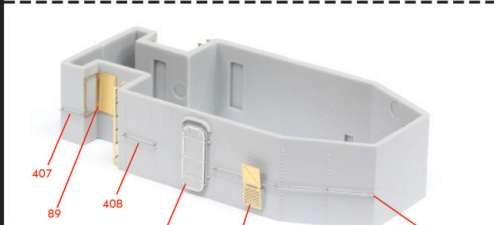
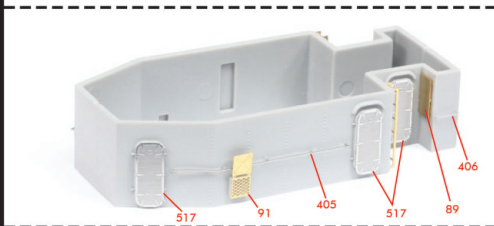
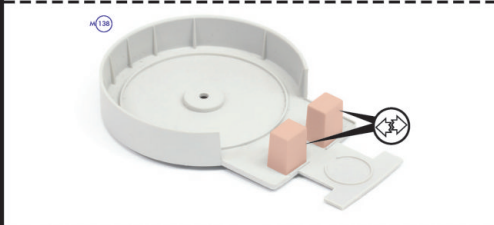
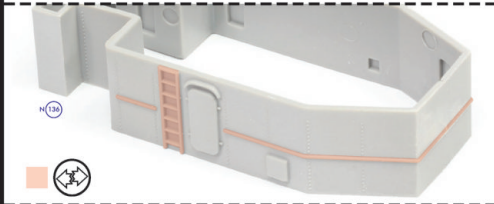

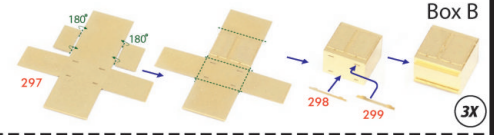
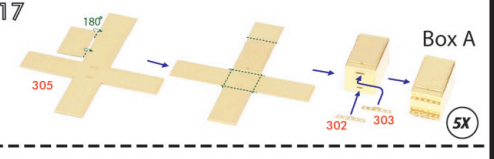
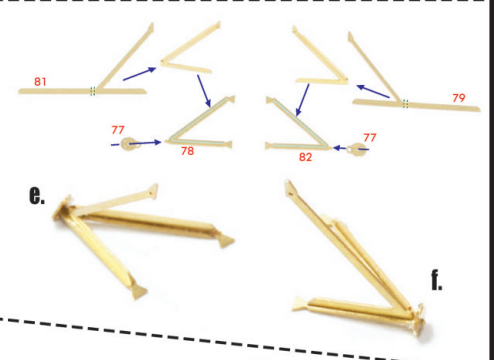
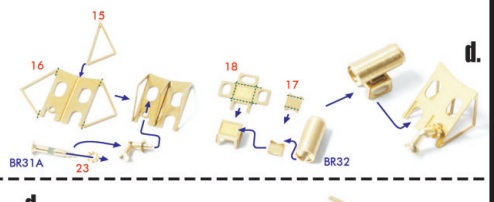
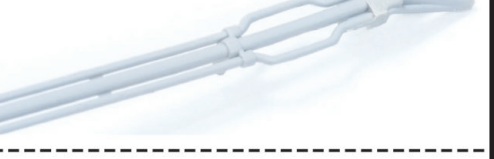
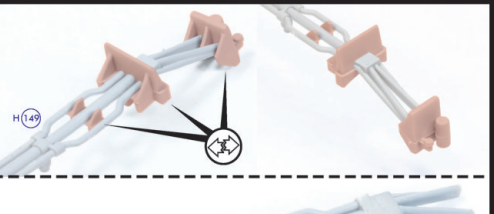
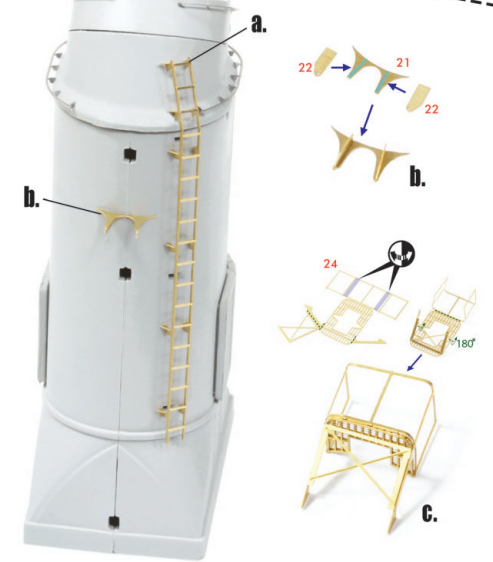
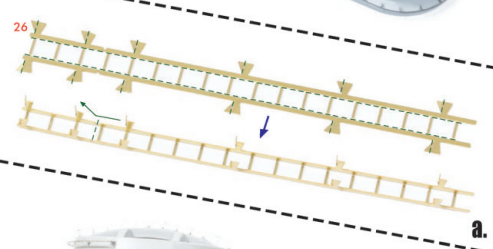
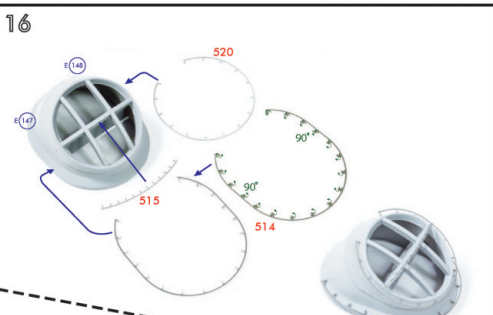
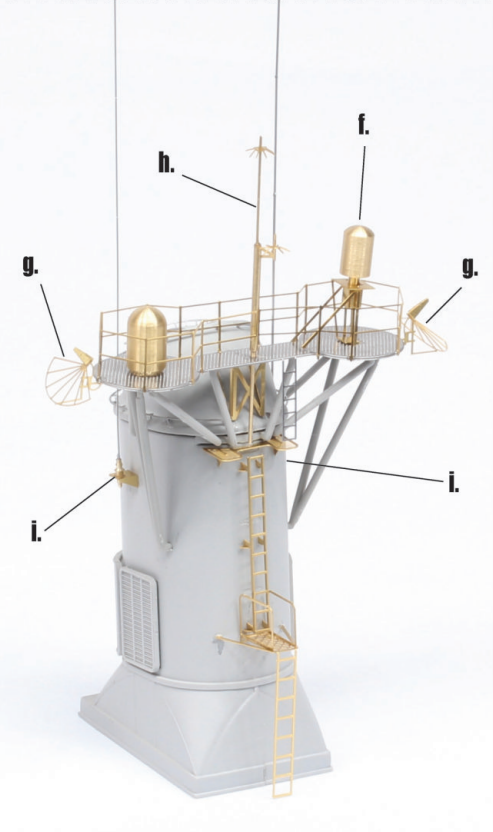
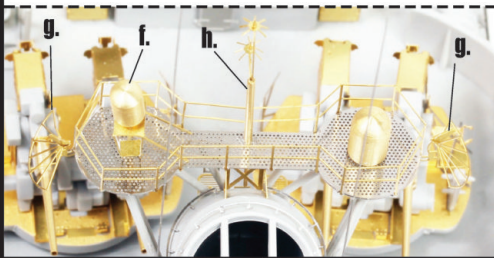
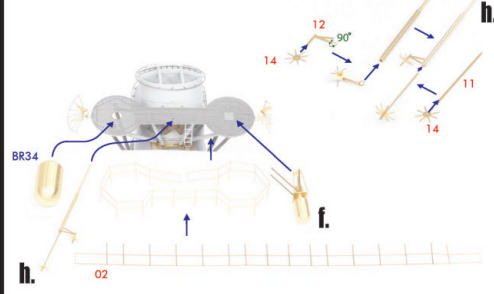
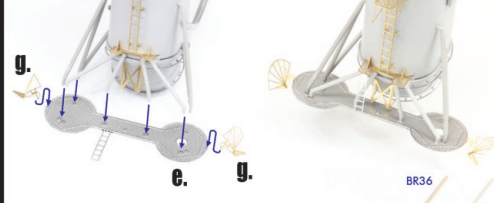
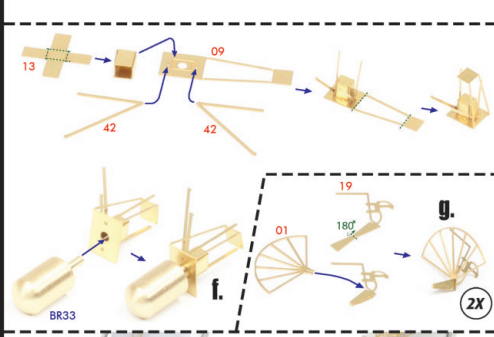
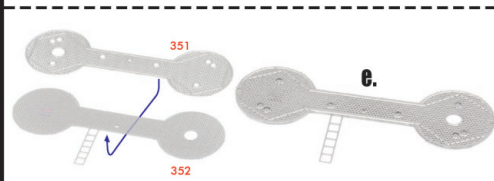
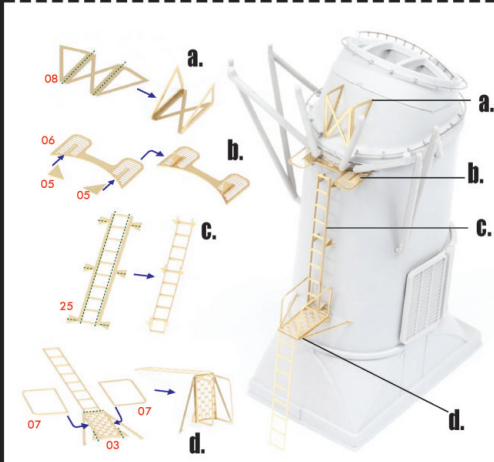
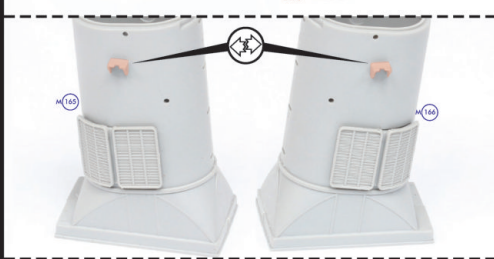
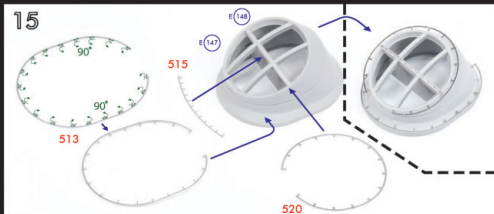

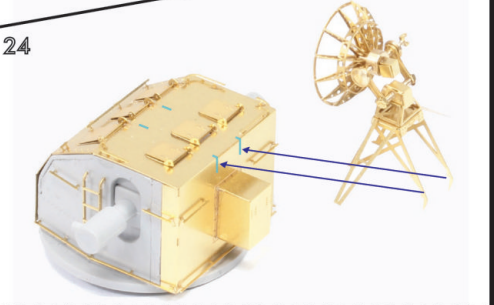
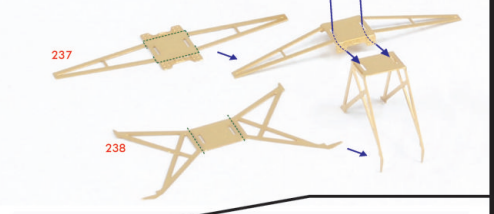
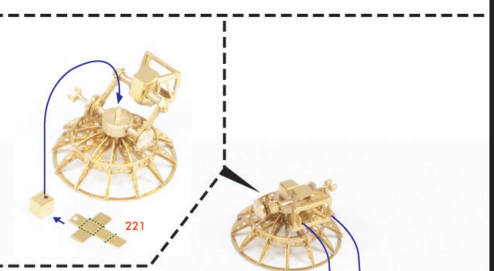
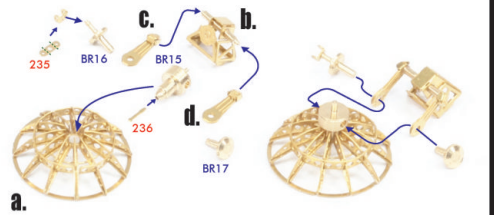
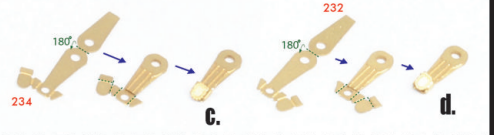
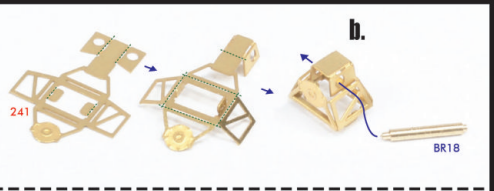
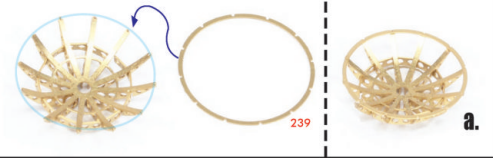
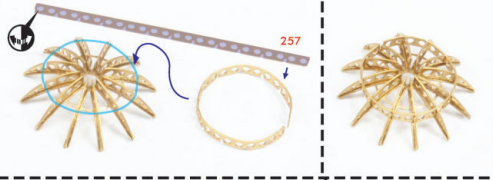
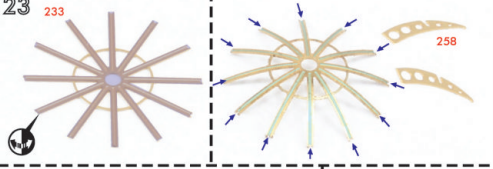
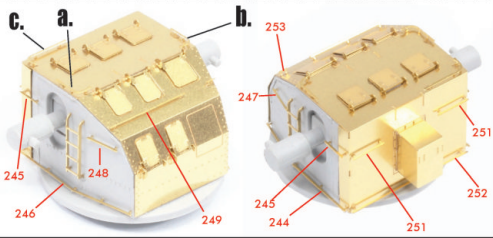
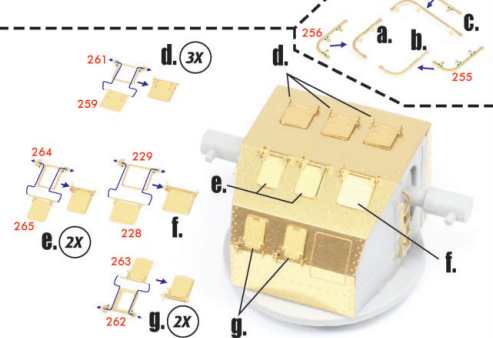
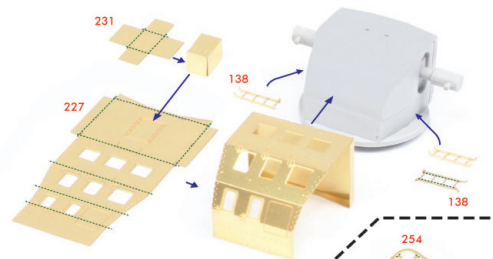
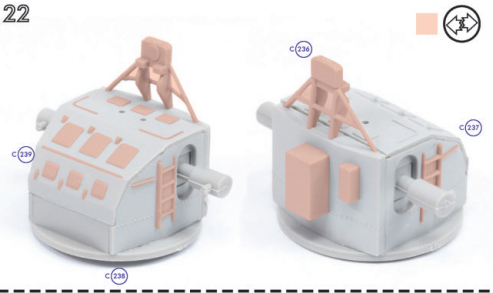
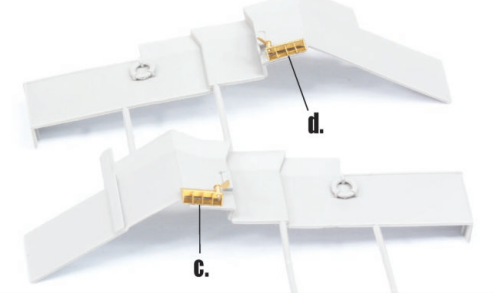
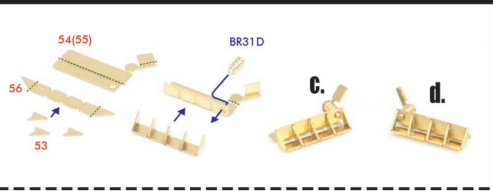
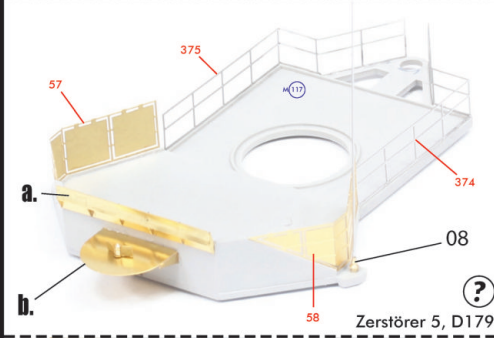
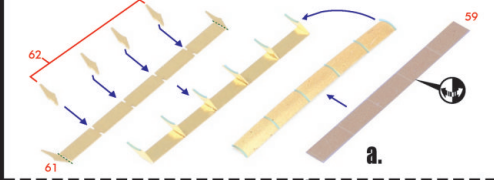

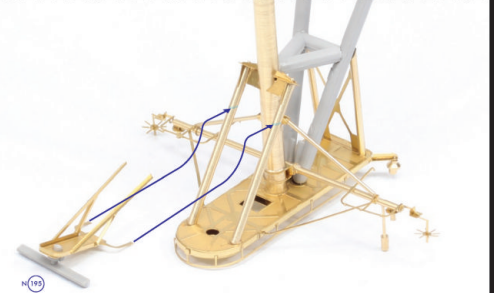
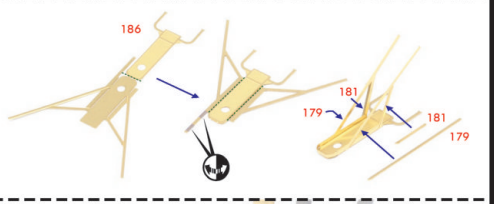
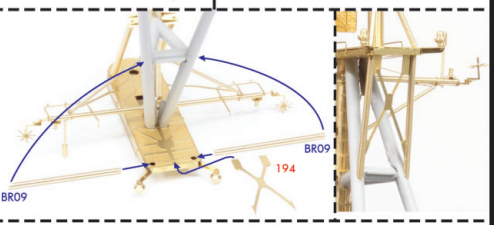
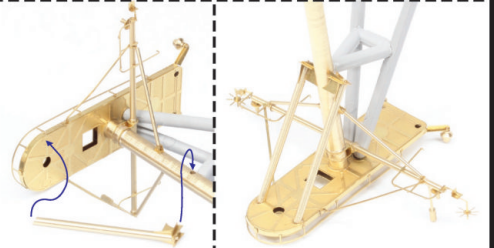
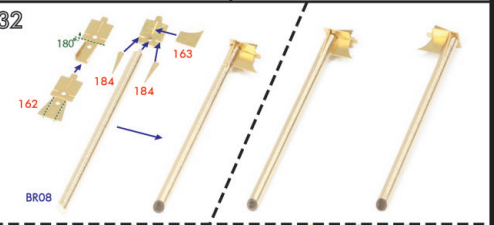
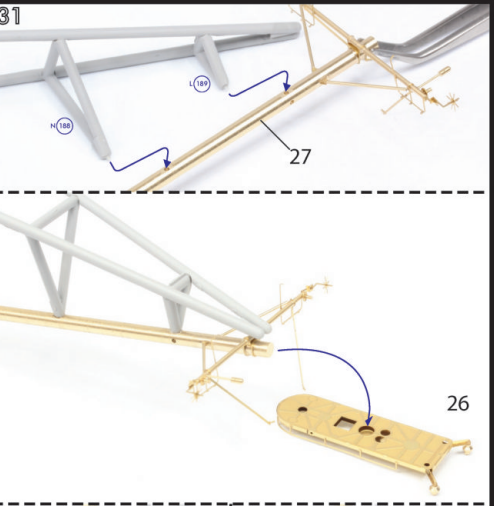
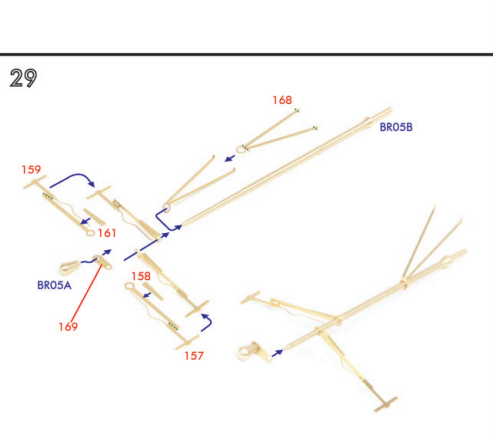
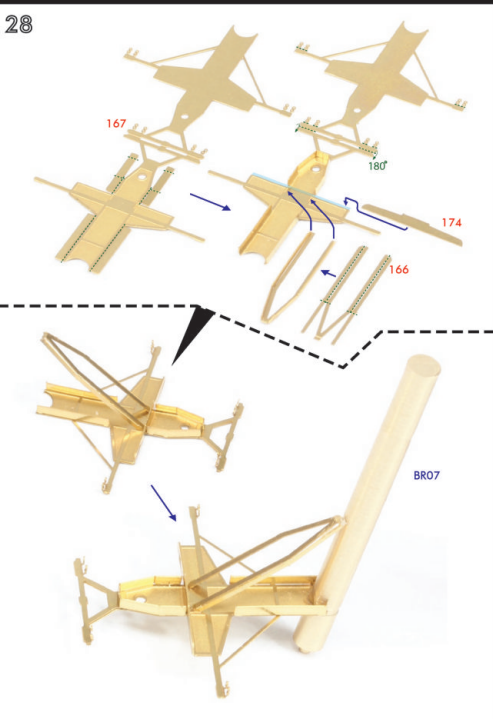
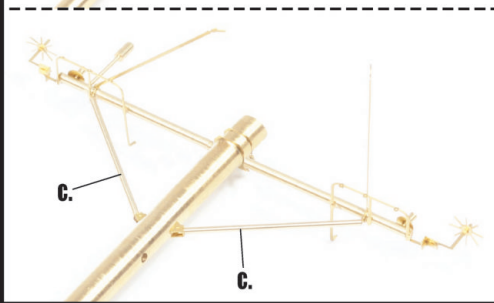
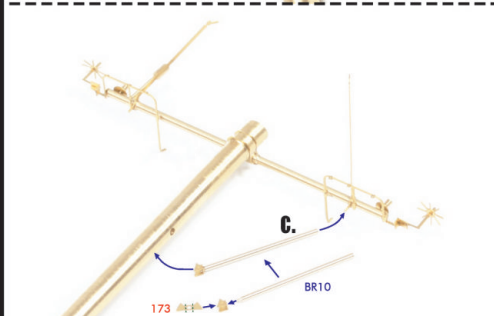
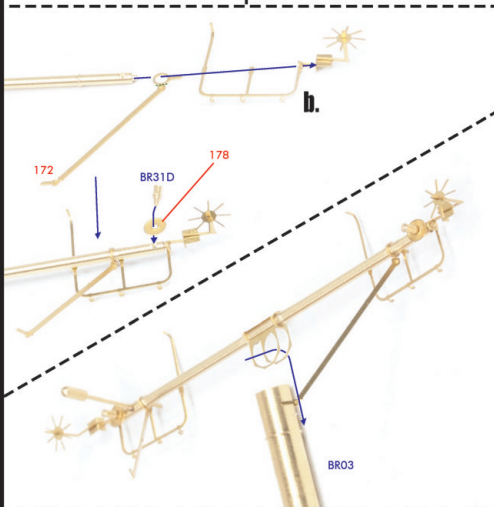
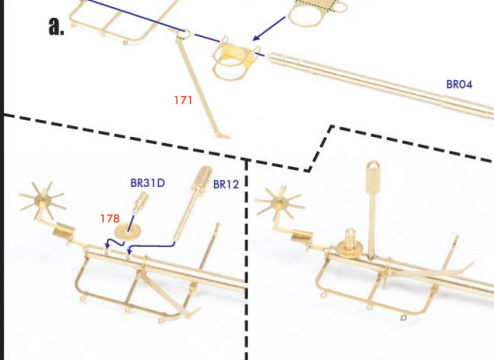
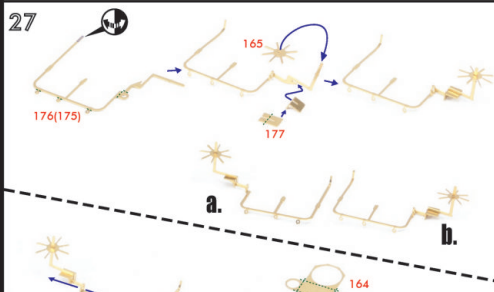
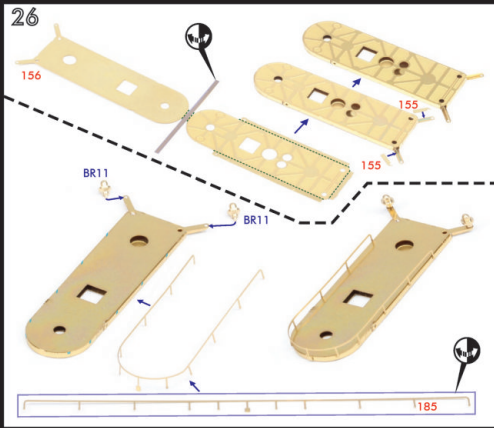

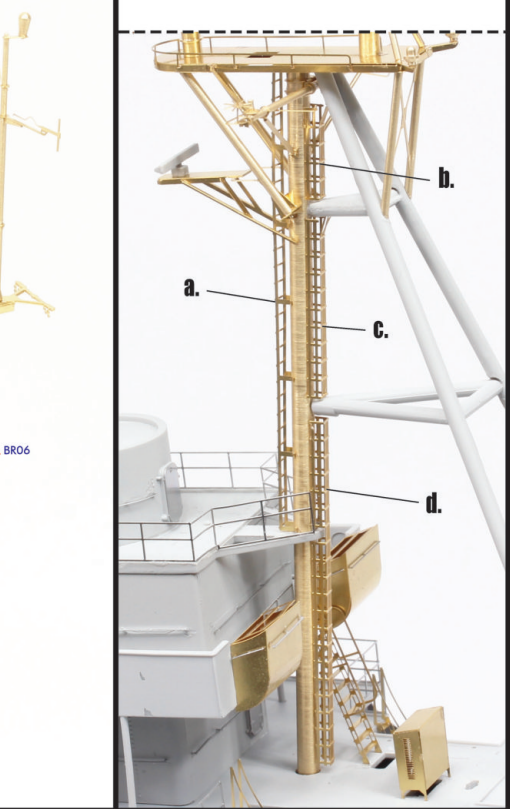
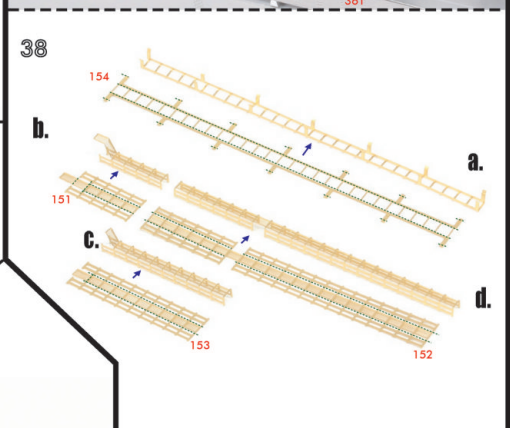
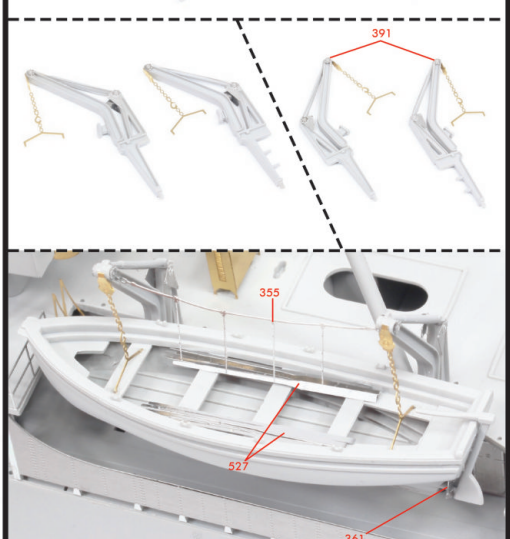
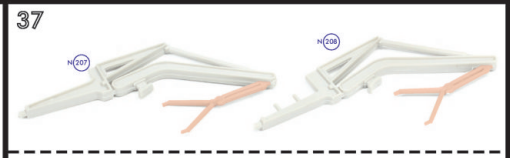
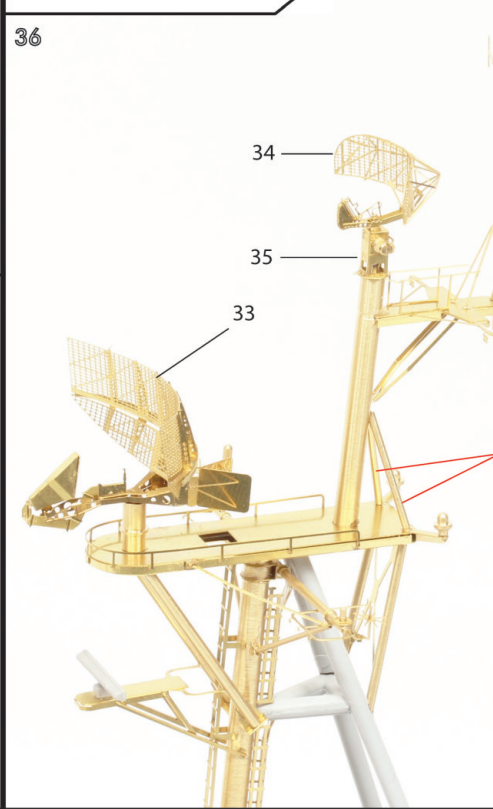
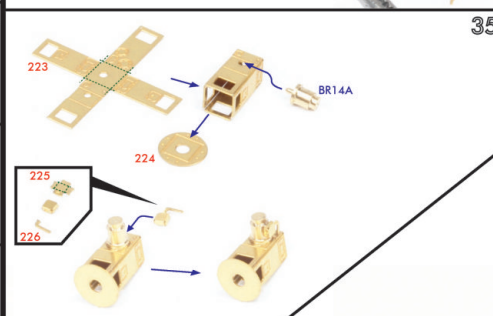
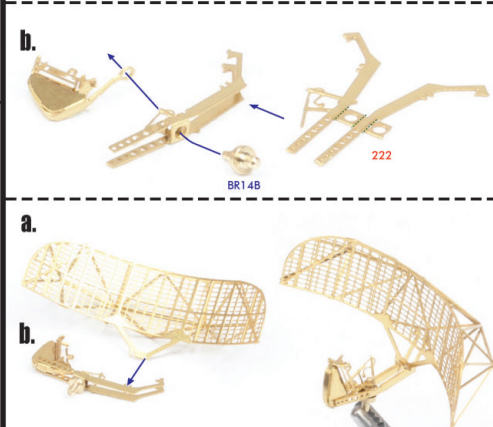
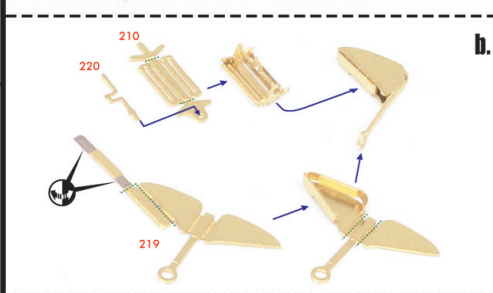
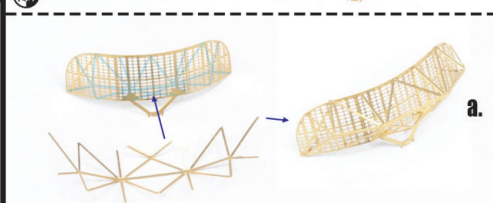
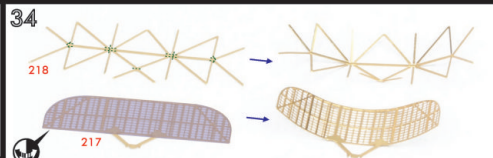
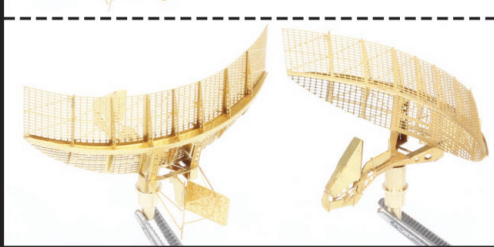
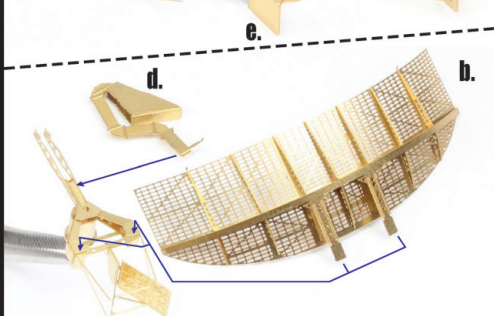
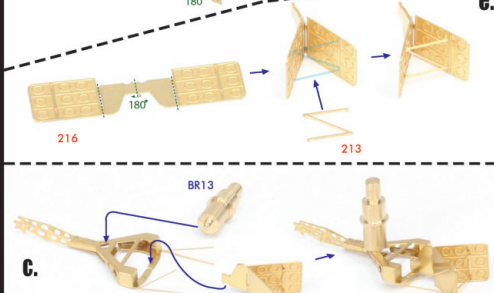
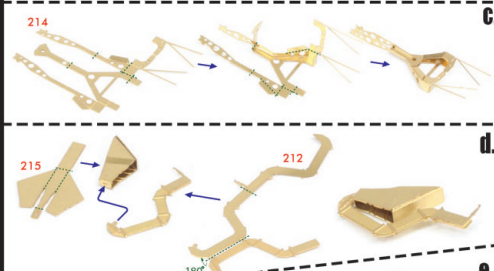
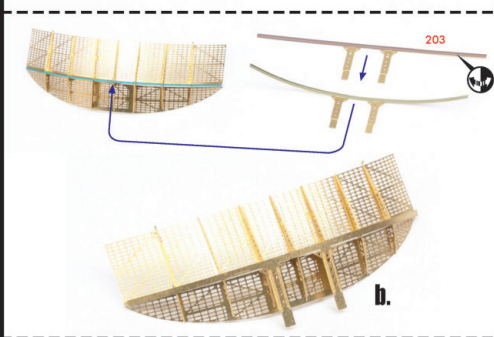
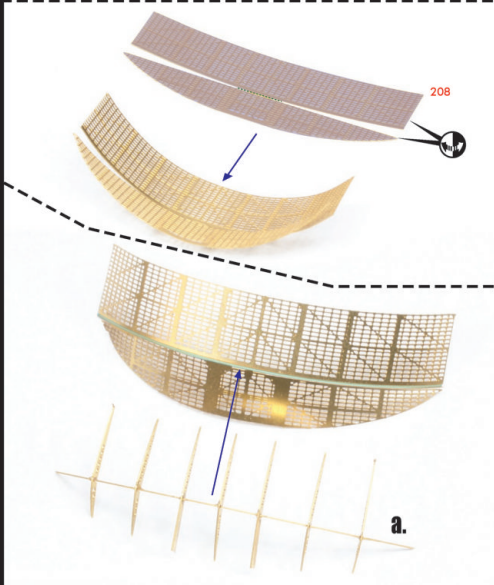
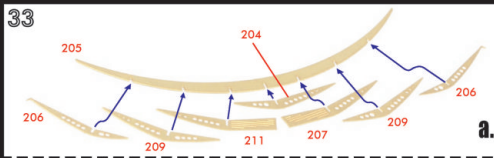

39

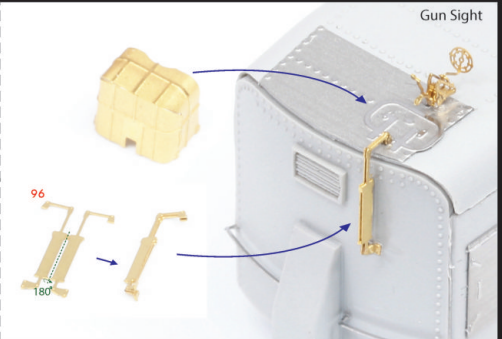
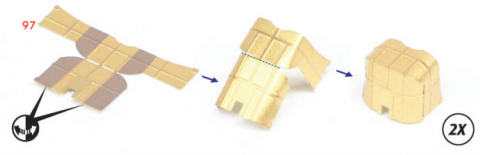
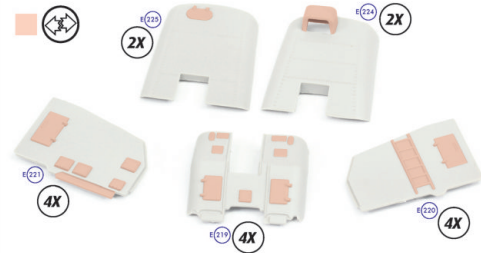

40

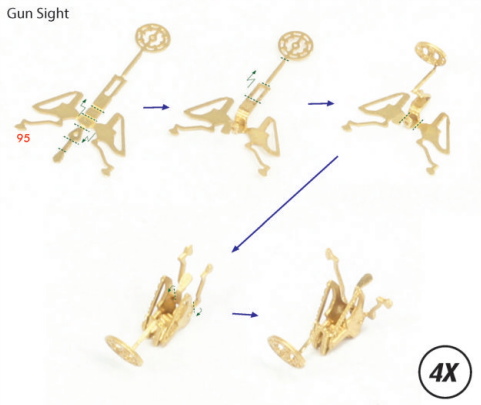
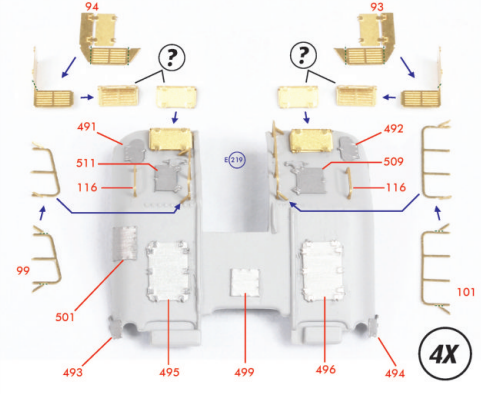
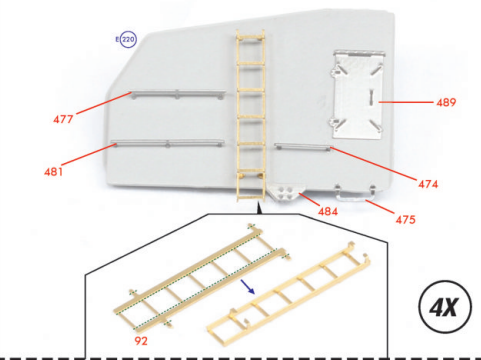
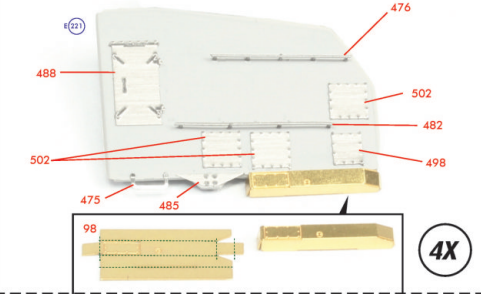
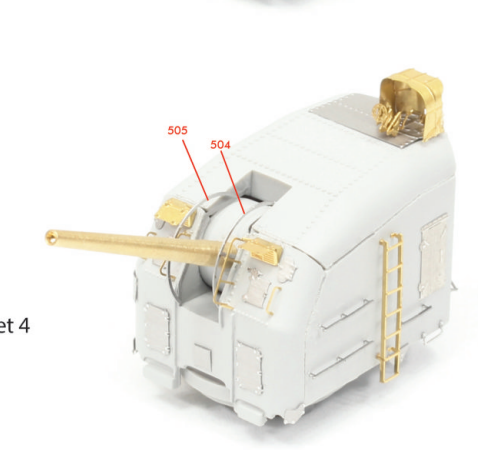
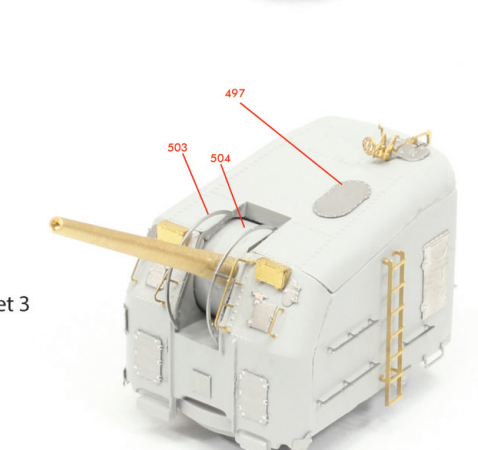
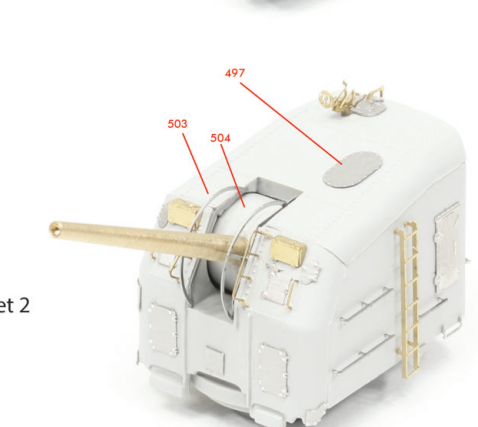
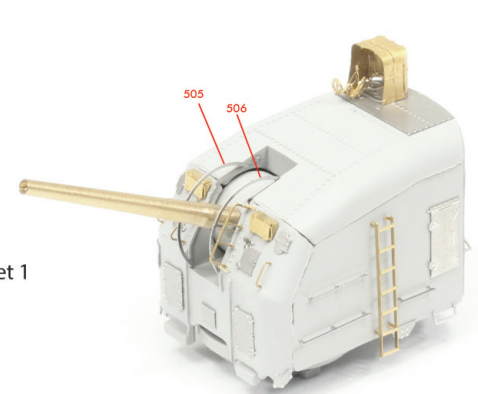

Turret 1

Turret 2

Turret 3

Turret 4

Gun Sight

Gun Sight

