



WORLD OF TANKS

LEVEL 4

1 2 3 4 5



SU-100



Beiliegenden Sicherheitstext beachten / Please note the enclosed safety advice

- Ⓢ Beiliegenden Sicherheitstext beachten und nachschlagbereit halten.
- Ⓢ Please note the enclosed safety advice and keep safe for later reference.
- Ⓢ Respecter les consignes de sécurité ci-jointes et les conserver à portée de main.
- Ⓢ Houdt u aan de bijgaande veiligheidsinstructies en hou deze steeds bij de hand.
- Ⓢ Seguire le avvertenze di sicurezza allegate e tenerle a portata di mano.
- Ⓢ Observar y siempre tener a disposición este texto de seguridad adjunto.
- Ⓢ Ter em atenção o texto de segurança anexo e guardá-lo para consulta.

- Ⓢ Overhold vedlagte sikkerhedsanvisninger og hav dem liggende i nærheden.
- Ⓢ Ha alltid vedlagt sikkerhetstekst klar til bruk.
- Ⓢ Beakta bifogad säkerhetstext och håll den i beredskap.
- Ⓢ Huomioi ja säilytä oheiset varoitukset.
- Ⓢ Соблюдать технику безопасности, сохранить инструкцию для дальнейших обращений.
- Ⓢ Przestrzegać załączonego tekstu dotyczącego bezpieczeństwa i mieć go zawsze pod ręką.
- Ⓢ Dodržujte tento příložený bezpečnostní text a mějte ho po ruce.
- Ⓢ A mellékelt biztonsági szöveget vegye figyelembe és tartsa fellepozásra készen.

- Ⓢ Rešpektujte priložený bezpečnostný text a uchovajte ho pre budúce použitie.
- Ⓢ Respectați textul de siguranță atașat și păstrați-l la îndemână.
- Ⓢ Спазвайте приложението за безопасност и го дръжте под ръка за справки.
- Ⓢ Prilolena varnostna navodila izvajajte in jih hranite na vsem dostopnem mestu.
- Ⓢ Λάβετε υπόψη σας το συννημένο κείμενο ασφαλείας και φυλάξτε το ώστε να ανατρέχετε σε αυτό όποτε χρειάζεται.
- Ⓢ Ektekgüvenlik talimatlarımı dikkate alıp, bakabileceğiniz bir şekilde muafaza ediniz.

YOUR SPECIAL BONUS AND STARTER PACK CODES!



DE BONUS-CODE (PC VERSION) FÜR ALLE SPIELER

Dieser Code schaltet die folgenden Goodies frei:

- ▶ **2x +50% Erfahrung für 2 Stunden**
- ▶ **2x +50% Credits für 2 Stunden und**
- ▶ **2x +200% Crew-Erfahrung für 2 Stunden**

Löse den Bonus-Code, spiele und beende die Mission im Spiel und sichere dir deine Belohnung!

Befolge diese Schritte, um den Code einzulösen: 1. Gehe auf <http://worldoftanks.eu/>
2. Logge dich mit deinem Konto ein. • 3. Klicke auf den Spielernamen oben rechts
4. Klicke auf „Wargaming-Code eingeben“ und gib den Code im Feld ein.

Deine individuellen Codes findest du auf dem beiliegenden Flyer. **Viel Spaß!**

GB BONUS CODE (PC VERSION) FOR ALL PLAYERS

This code unlocks the following in-game goods:

- ▶ **2x +50% Experience for 2 hours**
- ▶ **2x +50% Credits for 2 hours and**
- ▶ **2x +200% Crew experience for 2 hours**

Redeem your bonus code, play and complete the in-game mission, and enjoy your rewards!

To use the code please follow the steps below: 1. Go to http://worldoftanks.eu
2. Login to your account. • 3. Click on the user name in the top right corner.
4. Click "Activate Wargaming code" and enter the code into the field.

See the enclosed leaflet for your individual codes. **Enjoy!**

FR CODE BONUS (VERSION PC) POUR TOUS LES JOUEURS

Ce code permet de débloquer les bonus suivants :

- ▶ **2x +50% d'expérience pendant 2 heures**
- ▶ **2x +50% de crédits pour 2 heures et**
- ▶ **2x +200% Crew experience for 2 hours**

Suivez les étapes suivantes pour valider le code : 1. Allez sur <http://worldoftanks.eu/>
2. Connectez-vous à votre compte. • 3. Cliquez sur le nom du joueur dans le coin en haut à droite. • 4. Cliquez sur « Entrer le code wargaming » et entrez le code dans la case.

Vous trouverez vos codes individuels sur le flyer ci-joint. **C'est parti !**

NL BONUSCODE (PC-VERSIE) VOOR ALLE SPELERS

Deze code schakelt de volgende goodies vrij:

- ▶ **2x +50% ervaring voor 2 uur**
- ▶ **2x +50% credits voor 2 uur en**
- ▶ **2x +200% crew-ervaring voor 2 uur**

Wissel de bonuscode in, speel en voltooi de missie in het spel en verzeker je van je beloning!

Volg deze stappen om de code in te wisselen: 1. Ga naar <http://worldoftanks.eu/>
2. Log in met je account. • 3. Klik op de spelersnaam bovenaan rechts
4. Klik op "Wargaming-code invoeren" en geef de code in het veld in.

Je individuele code vind je op de bijgevoegde flyer. **Veel plezier!**

ES CÓDIGO DE BONIFICACIÓN (VERSIÓN PC)

PARA TODOS LOS JUGADORES

Este código desbloquea los siguientes beneficios:

- ▶ **2x +50 % experiencia durante 2 horas**
- ▶ **2x +50 % créditos durante 2 horas y**
- ▶ **2x +200 % experiencia de tripulación durante 2 horas**

¡Canjéa el código de bonificación, juega y termina la misión y hazte con tu recompensa!

Sigue estos pasos para canjear el código: 1. Ve a <http://worldoftanks.eu/>
2. Inicia sesión con tu cuenta. • 3. Haz clic en el nombre del jugador en la parte superior derecha. • 4. Haz clic en „Introducir código wargaming“ e introduce el código en el campo.

Encontrarás tus códigos individuales en el folleto adjunto. **¡Que te diviertas!**

IT CODICE BONUS (VERSIONE PER PC) PER TUTTI I GIOCATORI

Questo codice sblocca i seguenti bonus:

- ▶ **2x +50% esperienza per di 2 ore**
- ▶ **2x +50% crediti per 2 ore**
- ▶ **2x +200% esperienza di gruppo per di 2 ore**

Ricevi il codice bonus, gioca, termina la missione e aggiudicati la ricompensa!

Segui questi passi per ricevere il bonus: 1. Vai su <http://worldoftanks.eu/>
2. Accedi al tuo account. • 3. Clicca sul nome del giocatore in alto a destra
4. Clicca su "inserire codice wargaming" e digita il codice nella casella.

I tuoi codici personalizzati li trovi sul volantino in allegato. **Buon divertimento!**

DE EINLADUNGS-CODE (PC VERSION)

Dieser Code (ausschließlich für Neuspieler) schaltet die folgenden Goodies frei:

- ▶ **T2 Light Tank**
- ▶ **Garagenplatz**
- ▶ **7 Tage World of Tanks Premium Plus-Spielzeit**
- ▶ **1000 Gold**

Befolge diese Schritte um den Code einzulösen: 1. Gehe auf worldoftanks.com/revell
2. Gib den Code in das Feld ein und klicke auf Einlösen • 3. Erstelle euren neuen Account und ladet das Spiel herunter

Deine individuellen Codes findest du auf dem beiliegenden Flyer. **Viel Spaß!**

GB INVITE CODE (PC VERSION)

This code (for new players only) unlocks the following in-game goods:

- ▶ **T2 Light Tank**
- ▶ **Garage slot**
- ▶ **7 World of Tanks Premium plus days**
- ▶ **1000 Gold**

To use the code please follow the steps below: 1. Go to worldoftanks.com/revell
2. Enter the code into the field and click on Activate.
3. Register your new account and download the game.

See the enclosed leaflet for your individual codes. **Enjoy!**

FR CODE D'INVITATION (VERSION PC)

Ce code (réservé aux nouveaux joueurs) permet de débloquer les bonus suivants :

- ▶ **Tank léger T2**
- ▶ **Place de garage**
- ▶ **7 jours de temps de jeu World of Tanks Premium Plus**
- ▶ **1000 d'or**

Suivez les étapes suivantes pour valider le code : 1. Allez sur worldoftanks.com/revell
2. Entrez le code dans la case et cliquez sur « valider ».
3. Créez votre nouveau compte et téléchargez le jeu.

Vous trouverez vos codes individuels sur le flyer ci-joint. **C'est parti !**

NL UITNODIGINGSCODE (PC-VERSIE)

Deze code (uitsluitend voor nieuwe spelers) schakelt de volgende goodies vrij:

- ▶ **T2 light tank**
- ▶ **Garageplaats**
- ▶ **7 dagen World of Tanks Premium Plus-speeltijd**
- ▶ **1000 gold**

1. Ga naar worldoftanks.com/revell
2. Voer de code in het veld in en klik op inwisselen
3. Maak je nieuwe account en download het spel

Je individuele code vind je op de bijgevoegde flyer. **Veel plezier!**

ES CÓDIGO DE INVITACIÓN (VERSIÓN PC)

Este código (exclusivo para nuevos jugadores) desbloquea los siguientes beneficios:

- ▶ **T2 Light Tank**
- ▶ **Plaza de garaje**
- ▶ **7 días de World of Tanks Premium tiempo de juego plus**
- ▶ **1000 oro**

Sigue estos pasos para canjear el código:

1. Ve a worldoftanks.com/revell
2. Introduce el código en el campo y haz clic en „Canjear“
3. Crea tu nueva cuenta y descarga el juego

Encontrarás tus códigos individuales en el folleto adjunto. **¡Que te diviertas!**

IT CODICE INVITO (VERSIONE PER PC)

Questo codice (solo per nuovi giocatori) sblocca i seguenti bonus:

- ▶ **T2 Light Tank**
- ▶ **Garage**
- ▶ **7 giorni per giocare a World of Tanks Premium Plus**
- ▶ **1000 di oro**

Segui questi passi per ricevere il bonus:

1. Vai su worldoftanks.com/revell
2. Inserisci il codice nella casella e clicca su "ricevi"
3. Crea il tuo nuovo account e scarica il gioco

I tuoi codici personalizzati li trovi sul volantino in allegato. **Buon divertimento!**

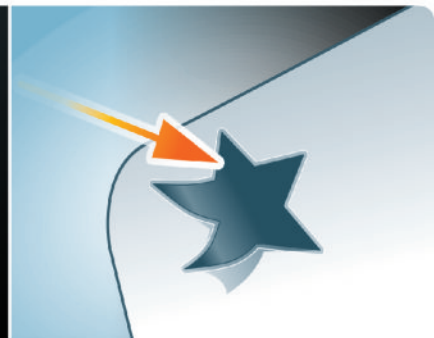
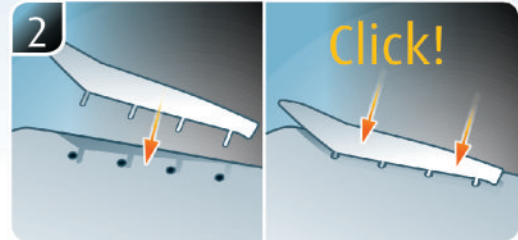
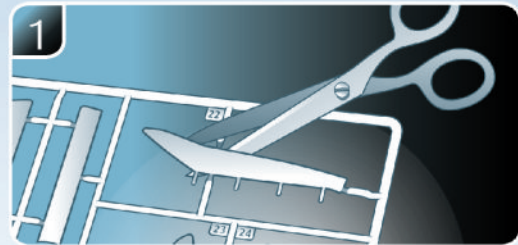
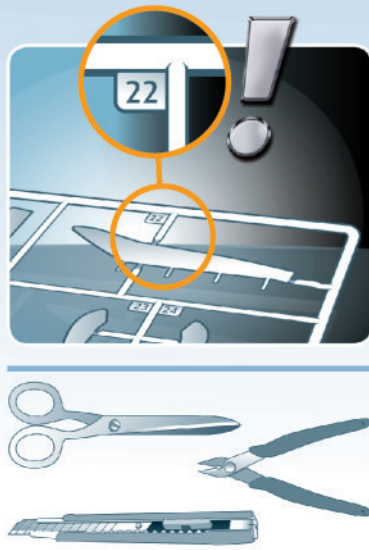

Painting



Decals

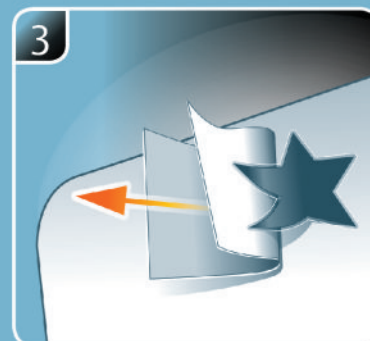
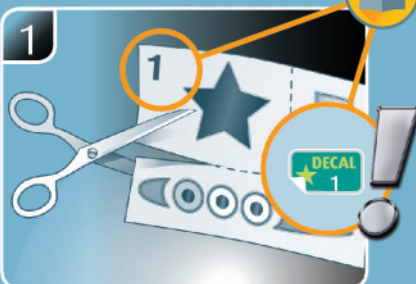

(D) Weitere Tipps und Tricks.
 (A) Additional tips and tricks.
 (F) Conseils et astuces supplémentaires.
 (N) Andere tips en trucs.
 (T) Ulteriori consigli e suggerimenti.
 (E) Consejos y sugerencias adicionales.
 (P) Mais dicas e truques.
 (X) Flere tips og tricks.
 (O) Flere tips og tricks.
 (Y) Ytterligare tips och tricks.
 (L) Lisää vinkkejä ja niksejä.
 (R) Другие советы и хитрости.

(P) Dalsze wskazówki i sugestie.
 (C) Další tipy a rady.
 (H) További ötletek és fogások.
 (S) Dalsie tipy a triky.
 (O) Alte sfaturi și trucuri.
 (B) Други полезни съвети и трикове.
 (S) Nadaljnji nasveti in zvižaje.
 (G) Πρόσθετες συμβουλές και κόλπα.
 (B) Diğer öneriler ve ipuçları.

www.revell.de

* (P) Opcional
 (X) Valgfritt
 (N) Valgfritt
 (S) Övrigt
 (F) Valinnainen
 (H) Дополнительно
 (L) Opcja
 (Z) Volitelný krok

(H) Opcióként
 (X) Voliteľné
 (N) Opcional
 (S) Опция
 (F) Dodatno
 (H) Προαιρετικά
 (B) Orsioyonel



- DE Kleben
- FR Glue
- FR Coller
- NL Lijmen
- IT Incollare
- ES Pegamento
- PT Colar
- DE Lim
- NO Lime
- SE Limma
- FI Liimaa
- RU Клеить
- PL Przykleić
- CZ Slepiti
- HU Ragassza rá
- SK Lepiť
- NO Lipiti
- DE Zulegenete
- FR Prilepíte
- GR ΚΑΛΗΘΕΤΕ
- TR Yapıştırma



- DE Nicht kleben
- FR Don't glue
- FR Ne pas coller
- NL Niet lijmen
- IT Non incollare
- ES No pegamento
- PT Não colar
- DE Lim ikke
- NO Ikke lime
- SE Limma inte
- FI Älä liimaa
- RU Не клеить
- PL Nie przyklejać
- CZ Nelepiti
- HU Ne ragassza rá
- SK Nelepiti
- NO Nu lipiti
- DE Не лепете
- FR Ne lepíte
- GR Μην καλήθετε
- TR Yapıştırmayın



- DE Bemalen
- FR Paint
- FR Peindre
- NL Beschilderen
- IT Colorare
- ES Pintar
- PT Pintar
- DE Mal
- NO Male
- SE Måla
- FI Maalaa
- RU Раскрасить
- PL Pomalować
- CZ Pomalovat
- HU Fesse be
- SK Natrieť
- NO Vopstij
- DE Боядисайте
- FR Robarvajte
- GR Βαψτε
- TR Boyama



- DE Anzahl der Arbeitsgänge.
- FR Number of working steps.
- FR Nombre d'étapes de travail.
- NL Het aantal bouwstappen.
- IT Numero di fasi di lavoro.
- ES Número de pasos de trabajo.
- PT Número de passos de trabalho.
- DE Antal arbejdsgange.
- NO Antall arbeidstrinn.
- SE Antal operationer.
- FI Työvaiheiden määrä.
- RU Количество операций.
- PL Liczba cykli roboczych.
- CZ Počet pracovních kroků.
- HU A munkamenetek száma.
- SK Počet pracovných operácií.
- NO Numáru etapelor de lucru.
- DE Брой работни стъпки.
- FR Stevilo delovnih postopkov.
- GR Αριθμός βημάτων εργασίας.
- TR Çalışma adımı sayısı.



- DE Zusammenbau Reihenfolge.
- FR Sequence of assembly.
- FR Ordre d'assemblage.
- NL Volgorde van montage.
- IT Sequenza di assemblaggio.
- ES Secuencia de montaje.
- PT Sequência de montagem.
- DE Samlerækkefølge.
- NO Monteringsrekkefølge.
- SE Montering ordningsföljd.
- FI Kokoamisjärjestys.
- RU Последовательность сборки.
- PL Kolejność montażu.
- CZ Pořadí složení.
- HU Összerakási sorrend.
- SK Poradie zostavenia.
- NO Ordinea asamblării.
- DE Последовательность на сглобяване.
- FR Vrstni red sestavljanja.
- GR Σειρά τοποθέτησης.
- TR Parçaları birleştirme sırası.



- DE Wahlweise
- FR Optional
- FR Facultatif
- NL Naar keuze
- IT Facoltativamente
- ES Opcional
- PT Opcional
- DE Valgfri
- NO Valgfritt
- SE Valfri
- FI Valinnaisesti
- RU На выбор
- PL Opcjonalnie
- CZ Volitelně
- HU Választás szerint
- SK Alternatívne
- NO Optional
- DE По избор
- FR Izbirno
- GR Προαιρετικά
- TR Opsiyonel



- DE Achtung
- FR Attention
- FR Attention
- NL Obgelet
- IT Attenzione
- ES Atención
- PT Atenção
- DE Obs!
- NO OBS
- SE OBS
- FI Huomio
- RU Внимание
- PL Uwaga
- CZ Pozor
- HU Figyelem!
- SK Pozor
- NO Atensjje
- FR Внимание
- GR Ποζορ
- TR Dikkat



- DE Bauanleitung sorgfältig lesen.
- FR Read the assembly instructions carefully.
- FR Lisez attentivement les instructions de montage.
- NL Bouwinstructies zorgvuldig doorlezen.
- IT Leggere attentamente le istruzioni per il montaggio.
- ES Lea cuidadosamente las instrucciones de montaje.
- PT Ler atentamente as instruções de montagem.
- DE Læs byggevejledningerne omhyggeligt.
- NO Les byggeanvisningene nøye.
- SE Monteringsinstruktionerna skall läsas noggrant.
- FI Lue kokoamisohje huolellisesti.
- RU Внимательно прочитайте инструкцию по сборке.
- PL Dokładnie przeczytać instrukcję montażu.
- CZ Přečtete si pečlivě návod k obsluze.
- HU Figyelmesen olvassa el a szerelési útmutatót.
- SK Návod na montáž starostlivo prečítajte.
- NO Citijti cu atenție instrucțiunile de montare.
- FR Прочетете внимателно урътането за монтаж.
- GR Σkrbno preberite navodila za sestavo.
- DE Διαβάστε προσεκτικά τις οδηγίες κατασκευής.
- TR Yapı kılavuzunu dikkatle okuyun.



- DE Loch bohren.
- FR Make a hole.
- FR Faire un trou.
- NL Maak een gat.
- IT Praticare un foro.
- ES Hacer un agujero.
- PT Fazer um furo.
- DE Lav et hull.
- NO Bor et hull.
- SE Borra hål.
- FI Poraa reikä.
- RU Просверлить отверстие.
- PL Wywiercić otwór.
- CZ Vyvrtejte otvor.
- HU Fúrjon lyukat.
- SK Vyvrťajte otvor.
- NO Faceți o gaură.
- FR Пробийте дупка.
- GR Izvrtaјte izvrtino.
- DE Ανοίξτε τη δούλα.
- TR Delik açın.



- DE Abbildung zusammengesetzter Teile.
- FR Illustration of assembled parts.
- FR Figure représentant les pièces assemblées.
- NL Afbeelding van samengevoegde onderdelen.
- IT Foto delle parti assemblate.
- ES Figura de las piezas montadas.
- PT Ilustração das peças montadas.
- DE Illustration af samlede dele.
- FR Figur av sammensatte deler.
- SE Bild på sammansatta detaljer.
- FI Kootujen osien kuva.
- RU Изображение смонтированных деталей.
- PL Rysunek połączonych części.
- CZ Zobrazení spojených dílů.
- HU Összerakott alkatrészek ábrája.
- SK Obrázok dielov, ktoré sa majú zmontovať.
- NO Figura reprezentând piesele asamblate.
- DE Изображение на сглобените части.
- FR Slika sestavljenih delov.
- GR Απεικόνιση των τοποθετημένων μερών.
- TR Birleştirilmiş parçaları resmi.



- DE Bauteile trocknen lassen.
- FR Allow the parts to dry.
- FR Laisser sécher les pièces.
- NL Onderdelen laten drogen.
- IT Lasciare asciugare i componenti.
- ES Dejar secar las piezas.
- PT Deixar as peças secar.
- DE Lad delene tørre.
- NO Tørk komponenter.
- SE Låt komponenterna torka.
- FI Anna rakenneosien kuivua.
- RU Дайте деталям высохнуть.
- PL Pozostawić elementy konstrukcji do wyschnięcia.
- CZ Nechte díly uschnout.
- HU Hagyja megszáradni az alkatrészeket.
- SK Konštrukčné diely nechajte vyschnúť.
- NO Lásati componentele să se usuce.
- DE Оставете сглобените части да изсъхнат.
- FR Osušite sestavne dele.
- GR Αφήστε τα μέρη να στεγνώσουν.
- TR Yapı parçalarını kurumaya bırakın.



- DE Mit einem Messer abtrennen.
- FR Detach with knife.
- FR Détacher au couteau.
- NL Met een mesje afsnijden.
- IT Separare con un coltello.
- ES Separar con cuchillo.
- PT Separar com uma faca.
- DE Skær af med en kniv.
- NO Separer med kniv.
- SE Skall skiljas av med en kniv.
- FI Erotta veitsellä.
- RU Отделить ножом.
- PL Oddzielić za pomocą noża.
- CZ Oddělte nožem.
- HU Válassza le késsel.
- SK Oddelte nožom.
- NO Desprindeți cu un cuțit.
- FR Откъснете с нож.
- GR Οδρεζίτε z ustreznim rezilom.
- DE Αραιρέστε με ένα μαχαίρι.
- TR Bir bıçak ile kesin.



- DE Abziehbild in Wasser einweichen und anbringen.
- FR Soak and apply decals.
- FR Mouiller et appliquer les décalcomanies.
- NL Transfer in water even laten weken en aanbrengen.
- IT Immergere la decalcomania nell'acqua e applicarla.
- ES Mojar y aplicar calcomanías.
- PT Amolecer o decalque em água e aplicar.
- DE Gør overføringsbilledet vådt og sæt det på.
- NO Myk opp avtrekkingsbildet i vann og sett på.
- SE Blötlägg dekalen i vatten och sätt på den.
- FI Pehmitä siirtokuvua vedessä ja siirtä raikalleen.
- RU Опустите переводную картинку в воду и нанесите её.
- PL Namoczyć kalkomanie w wodzie i przykleić.
- CZ Nechte obtisk odmočit ve vodě a přilepte.
- HU Merítse vízbe és helyezze fel a matricát.
- SK Otblačkovy obrázok namočte do vody a priložte na plochu.
- NO Inmjuati abtjibildul in apă și aplicați-l.
- DE Потопете ваденката във вода и я поставяте.
- FR Prelepnicio patakajte v vodi. In namestite.
- GR Μουσκεψτε σε νερό και τοποθετήστε τις χαλκομανίες.
- TR Çıkartmayı suda yumuşatın ve takın.



- DE Zur Anbringung der Abziehbilder empfohlen.
- FR Recommended for affixing the decals.
- FR Recommandé pour l'application des décalcomanies.
- NL Aanbevolen voor het aanbrengen van de transfers.
- IT Raccomandato per l'applicazione delle decalcomanie.
- ES Recomendado para fijar bien las calcomanías.
- PT Recomendado para a fixação dos autocolantes.
- DE Anbefales til anbringelse af overføringsbillederne.
- NO Anbefales til å feste avtrekkingsbilder.
- SE Rekommenderad för montering av klisterdekalerna.
- FI Suositellaan siirtokuvien siirtämiseen.
- RU Рекомендуется для нанесения переводных картинок.
- PL Zalecane do przyklejenia kalkomanii.
- CZ Doporučujeme k umístění obtiskovacích obrázků.
- HU A matrica felhelyezéséhez ajánlatos.
- SK Odporúča sa pre umiestnenie obtlačkového obrázku.
- NO Recomandat pentru aplicarea abtjibidurilor.
- DE Препоръчва се за поставяне на ваденки.
- FR Pri nameštanju nalepnic priporočamo.
- GR Συνιστάται για την τοποθέτηση των χαλκομανιών.
- TR Çıkartmaların takılması için önerilir.



- DE Nicht enthalten
- FR Not included
- FR Non fourni
- NL Behoort niet tot de levering
- IT Non incluso
- ES No incluido
- PT Não incluído
- DE Medfølger ikke
- NO Ikke inkludert
- SE Ingår ej
- FI Ei sisällä
- RU Не содержится
- PL Nie wchodzi w zakres dostawy
- CZ Není obsaženo
- HU Nem tartalmazza
- SK Neobsahuje
- NO Nu este inclus
- FR Не се включва в комплекта
- GR Ni priloženo
- DE Δεν περιλαμβάνεται
- TR İçermiyor

Benötigte Farben / Required colours

- FR Peintures nécessaires
- NL Benodigde kleuren
- IT Colori necessari
- ES Colores necesarios
- PT Cores necessárias
- DK Nødvendige farver
- NO Nødvendige farger
- SE Erforderliga färger
- FI Tarvittavat värit
- RU Необходимые краски
- PL Potrzebne kolory
- CZ Potřebné barvy
- HU Szükséges színek
- SK Pozadované farby
- RO Culori necesare
- BG Необходими цветове
- SI Potrebne barve
- GR Απαιτούμενα χρώματα
- TR Gerekl renkler

91

A

- DE Eisen metallic
- GB Iron metallic
- FR Fer métallique
- NL Ijzer metallic
- IT Ferro metallico
- ES Acero metálico
- PT Aço metálico
- DK Stål metallisk
- NO Jern metallic
- SE Stål metallic
- FI Teräs metallinen
- RU Сталь металлик
- PL Grafit metaliczny
- CZ Ocelová metalizový
- HU Acélmetál
- SK Ocelová metaliza
- RO Fier metallic
- BG Желязо металик
- SI Železna kovinska
- GR Χρώμα σιδήρου μεταλλικό
- TR Metalik metalik

09

B

- DE Anthrazit matt
- GB Anthracite matt
- FR Anthracite mat
- NL Antraciet mat
- IT Antracite opaco
- ES Antracita mate
- PT Antracite mate
- DK Antracitgrå mat
- NO Antrasitt matt
- SE Antracitgrå matt
- FI Antrasiitinharmaa matta
- RU Антрацит матовый
- PL Antracyt matowy
- CZ Antracitová šedá matný
- HU Antracit, fénytelen
- SK Čierna uhlová matný
- RO Antracit mat
- BG Антрацит матово
- SI Antracit mat
- GR Γκρι ανθρακί ματ
- TR Anrazit mat

83

C

- DE Rost matt
- GB Rust matt
- FR Rouille mat
- NL Roest mat
- IT Ruggine opaco
- ES óxido mate
- PT Ferrugem mate
- DK Rust mat
- NO Rust matt
- SE Rost matt
- FI Ruoste matta
- RU Ржавый матовый
- PL Rdzawy matowy
- CZ Rezavá matný
- HU Rozsdszínú, fénytelen
- SK Hrdzavá matný
- RO Ruginiu mat
- BG Ръжда матово
- SI Rjasta mat
- GR Χρώμα σκουριάς ματ
- TR Pas rengi mat

382

D

- DE Holzbraun seidenmatt
- GB Wood brown silk matt
- FR Brun bois satiné mat
- NL Houtbruin zijdemat
- IT Marrone legno opaco satinato
- ES Marrón madera mate satinado
- PT Castanho madeira mate sedoso
- DK Træbrun silkematt
- NO Trebrun silkematt
- SE Tråbrun sidenmatt
- FI Puunruskea silkkimatta
- RU Древесно-коричневый шелковисто-матовый
- PL Brązowy w odcieniu drewna jedwabście matowy
- CZ Dřevěná hnědá jemně matný
- HU Fa barna, fakóselymes
- SK Drevená hnedá hodvábne matný
- RO Maro lemnos satinat
- BG Дървеснокафяво коприненоматово
- SI Lesno-rjava svilenomat
- GR Καφέ ανοιχτό σατινέ
- TR Ahşap rengi ipeksi mat

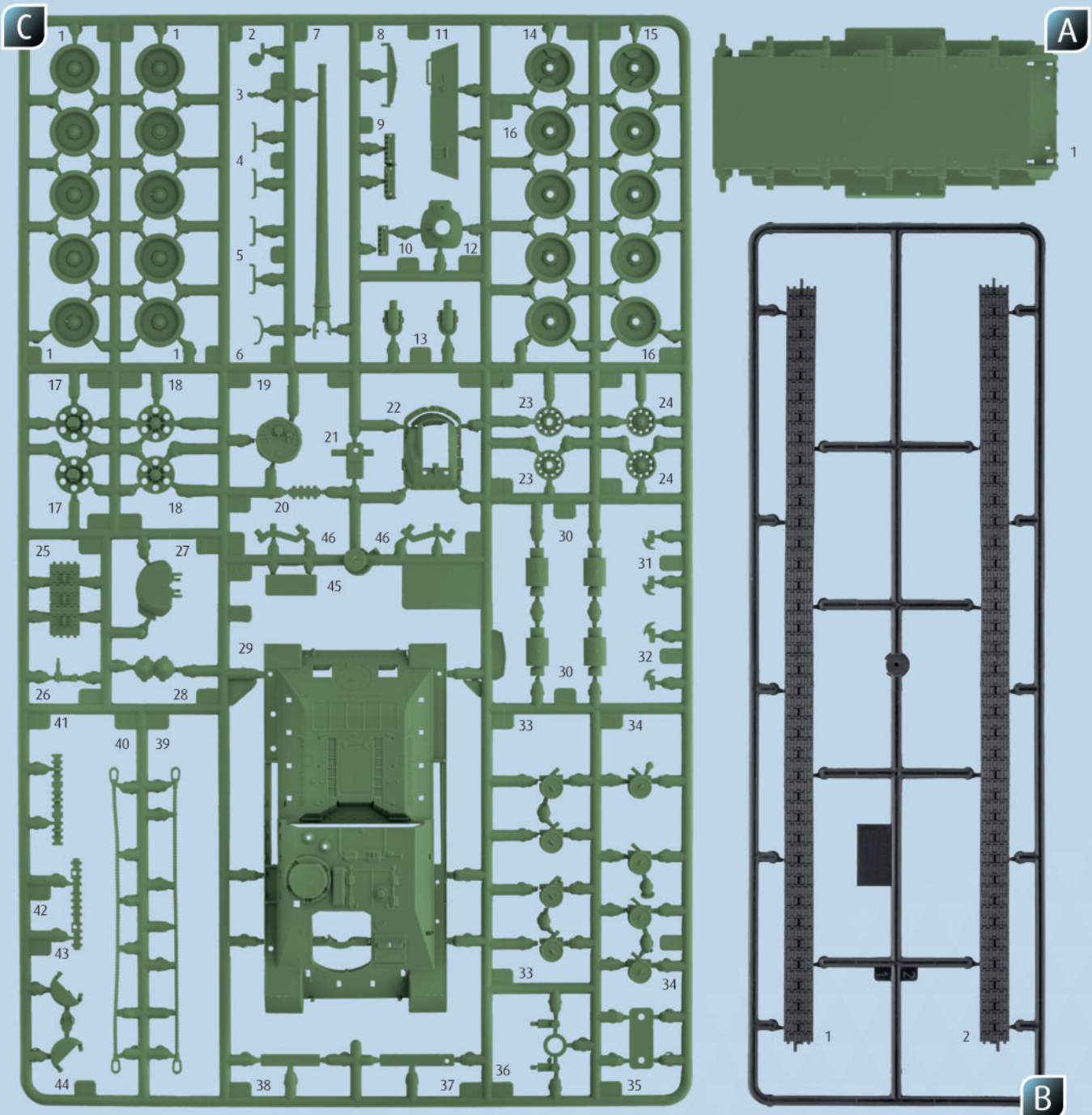

Ersatzteile benötigt?

Kein Problem. Einfach den Revell-Service mit Angabe von Artikel- und Teilenummer kontaktieren. Entweder unter service@revell.de oder Revell GmbH, Abteilung X, Henschelstr. 20-30, 32257 Bünde.*

*Wir bitten um Verständnis, dass eine Gewährleistung nur bei aktuellen Artikeln, die im Zeitraum der letzten 24 Monate erworben wurden, übernommen werden kann. Mit der Ersatzteil-Bestellung können Kosten z.B. für Verpackung und Versand entstehen. Ob diese Kosten anfallen wird im Vorfeld schriftlich durch unseren Service mitgeteilt. Das Angebot kann dann angenommen oder abgelehnt werden. Unfrei eingesandte Ersatzteil-Bestellungen werden von uns nicht angenommen! Dieser Direktservice gilt für die Länder Deutschland, Benelux, Österreich, Frankreich, Großbritannien. Ersatzteil-Bestellungen aus den übrigen Ländern werden über die jeweiligen Distributeure abgewickelt. Bitte kontaktieren Sie Ihren Händler.

Besoin de pièces de rechange ?

Il vous suffit de contacter le service Revell et d'indiquer la référence de l'article et de la pièce. Soit en écrivant par mail à france@revell.de (uniquement pour la France) ou par courrier à Revell GmbH, Département X, Henschelstr. 20-30, D-32257 Bünde.*

*La garantie s'applique pour les articles présents au catalogue et achetés au cours des 24 derniers mois. Merci de votre compréhension. La commande de pièces de rechange peut donner lieu à des frais supplémentaires, par ex. pour l'emballage et le port. Notre service client vous en informera au préalable par écrit. Vous pourrez accepter ou refuser le devis. Nous n'acceptons pas les commandes de pièces de rechange envoyées sans affranchissement ! Ce service direct est valable pour les pays suivants : Allemagne, Benelux, Autriche, France, Grande-Bretagne. Les commandes de pièces en provenance d'autres pays sont traitées par les distributeurs correspondants. Veuillez contacter votre revendeur.

Need spare parts?

No problem. Contact Revell Service with the item number and part numbers you need: service@revell.de or Revell GmbH, Unit 10, Old Airfield Industrial Estate, Cheddington Lane, Tring, Herts, HP23 4QR, Great Britain.*

*We request your understanding that a warranty can only be accepted for current articles which have been purchased in the last 24 months. Orders for spare parts may also be subject to costs for packaging and shipping. You will be notified in advance by our Service department if such costs are incurred. The offer can then be accepted or rejected. We will not be able to process any postal requests unless correct postage has been applied to mailing! This direct service applies to the countries: Germany, Benelux, Austria, France, and the United Kingdom. Spare part orders from other countries are processed by the local distributors. Please contact your dealer.

Hebt u reserveonderdelen nodig?

Geen probleem! Neem eenvoudig contact op met de klantenservice van Revell en geef ons het artikel- en onderdeelnummer door. U kunt ons bereiken op service@revell.de of per post: Revell GmbH, Afdeling X, Henschelstr. 20-30, 32257 Bünde.*

*Wij vragen uw begrip voor de omstandigheid, dat er alleen garantie kan worden geboden voor actuele artikelen, die in de afgelopen 24 maanden zijn gekocht. Met het bestellen van reserveonderdelen kunnen kosten gemoeid zijn, bijv. voor verpakking en verzending. U wordt vooraf schriftelijk door onze klantenservice op de hoogte gesteld als er kosten zouden ontstaan. Het aanbod kan dan worden aangenomen of afgewezen. Wij nemen geen ongefrankeerde bestellingen van reserveonderdelen aan! Deze rechtstreekse service wordt verleend in de landen Duitsland, de Benelux, Oostenrijk, Frankrijk en Groot-Brittannië. Bestellingen van reserveonderdelen in de overige landen worden afgewikkeld via de betreffende distributeurs. Neem hiervoor contact op met uw verkoper.

1

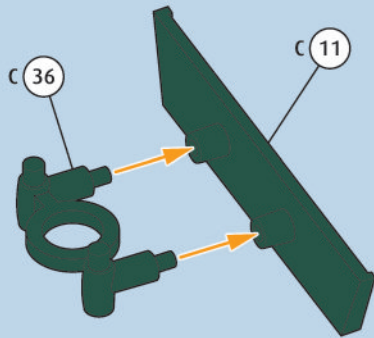

2

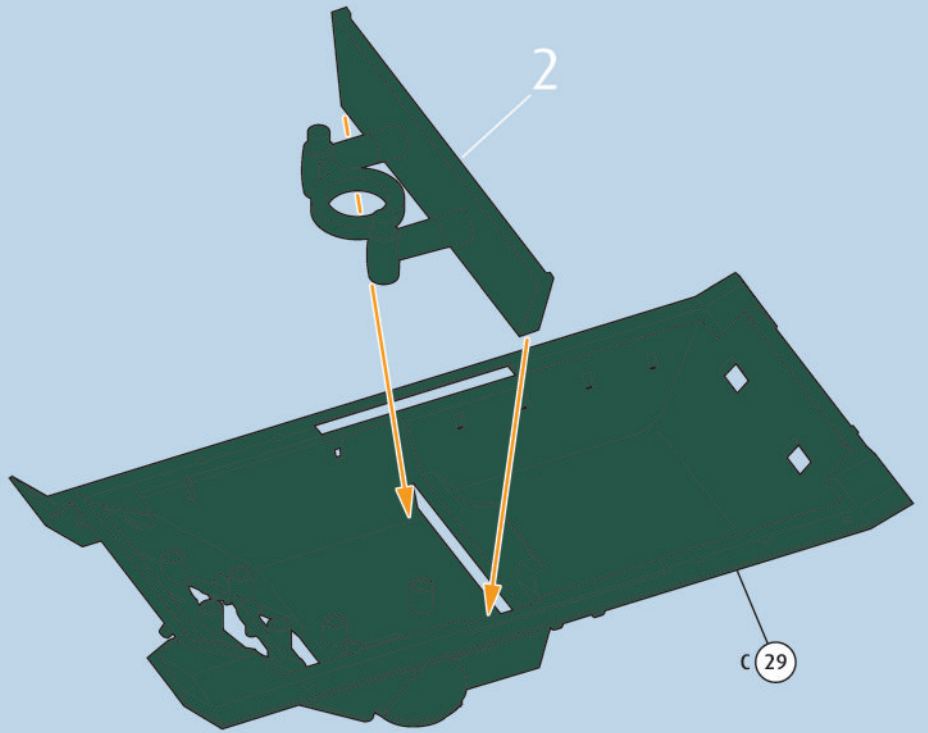

3

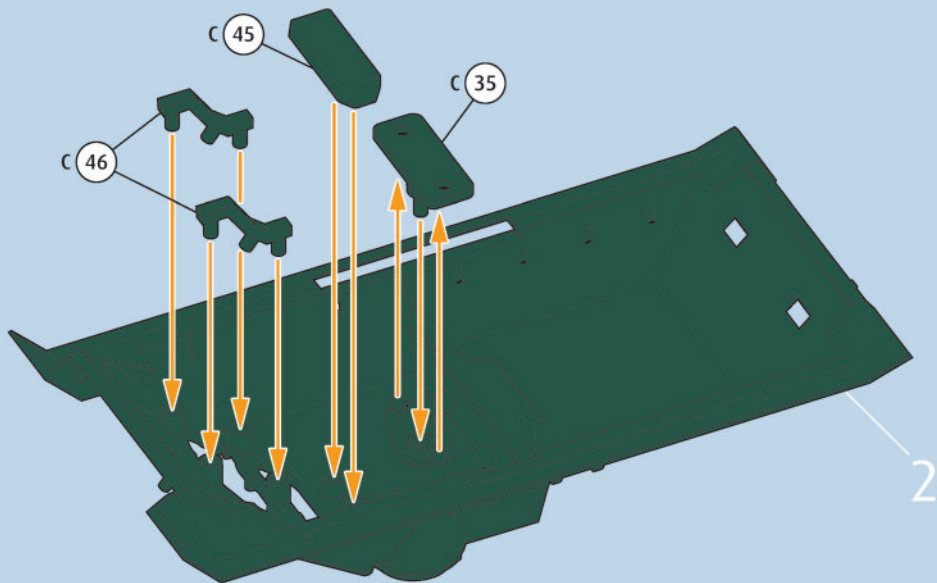

4

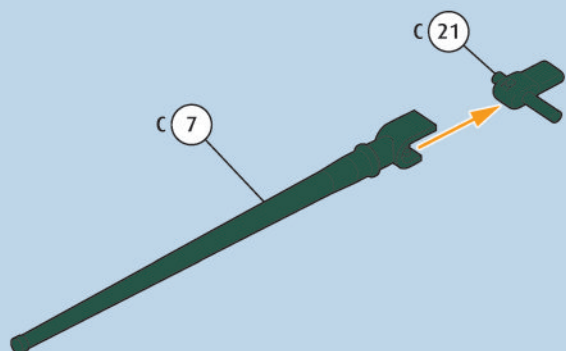

5

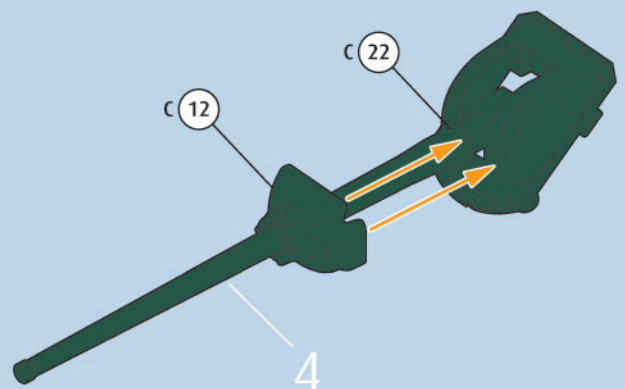

6

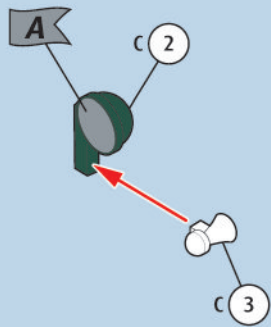

7

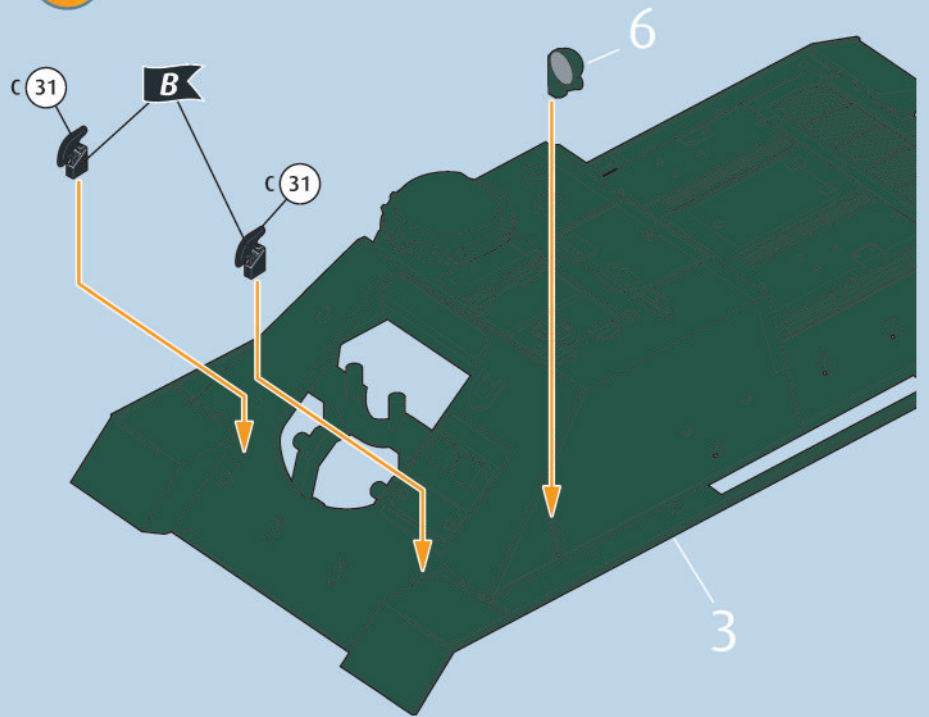

8

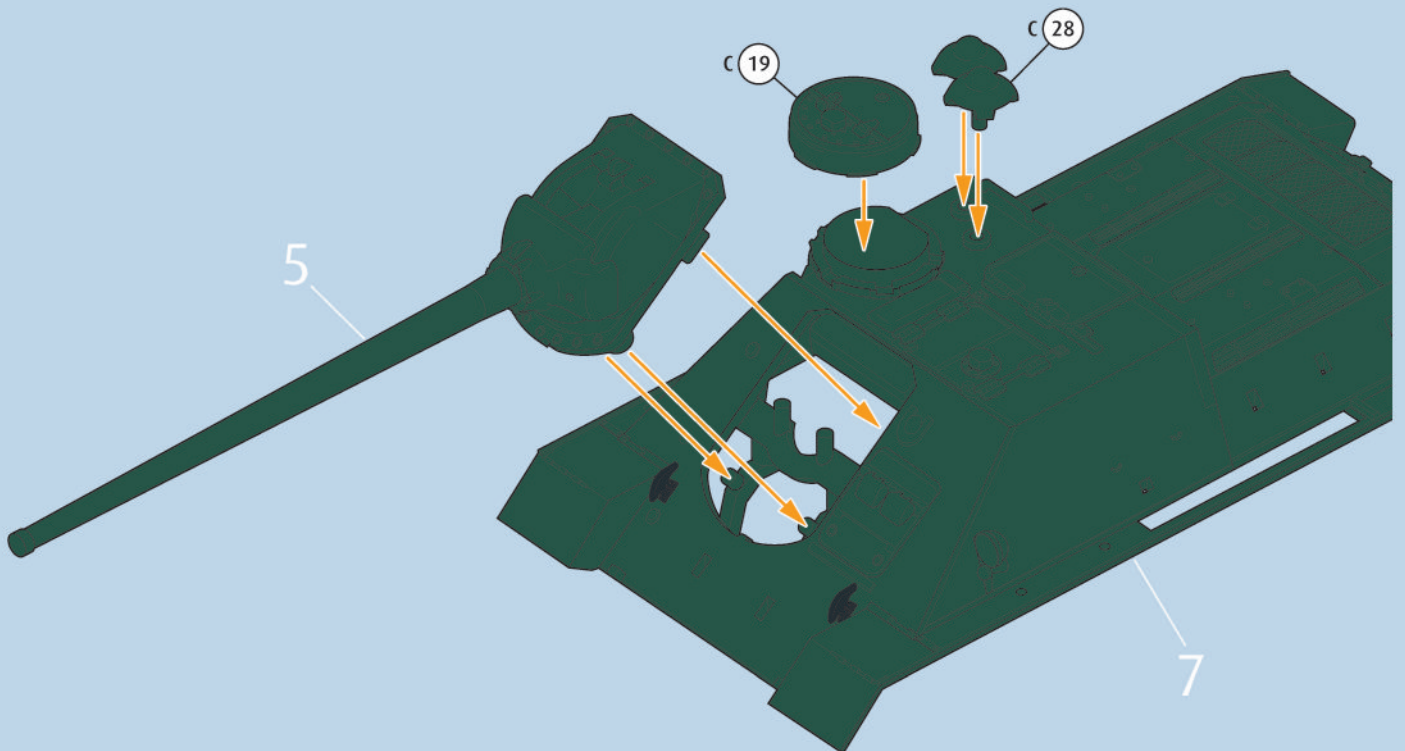

9

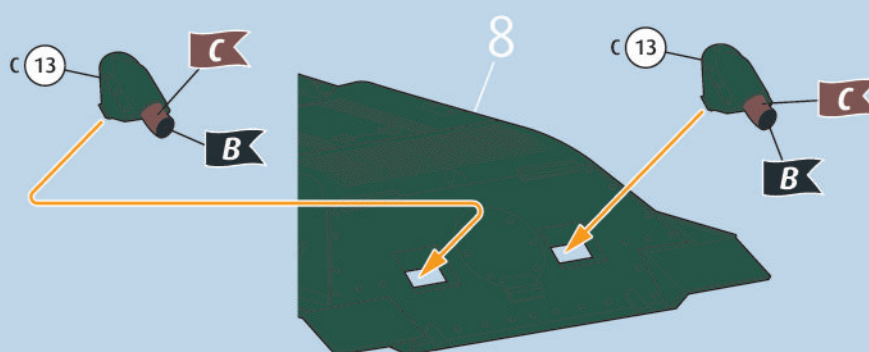

10

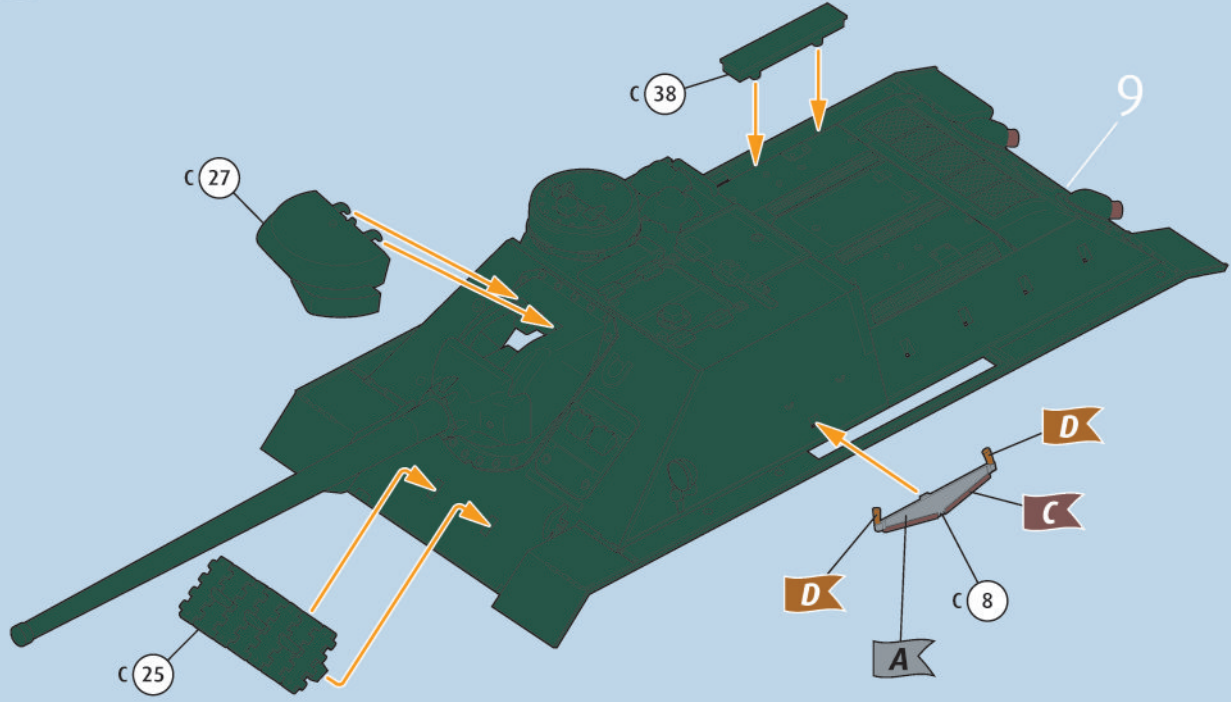

11

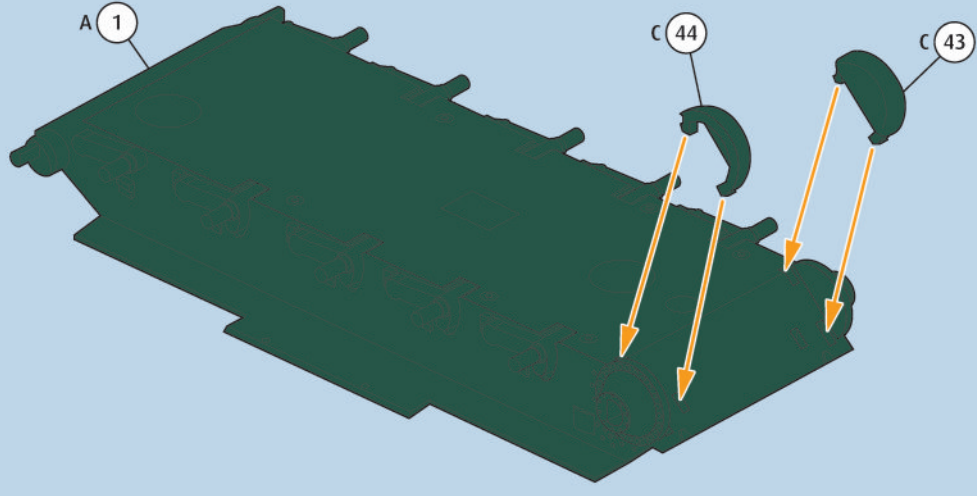

12

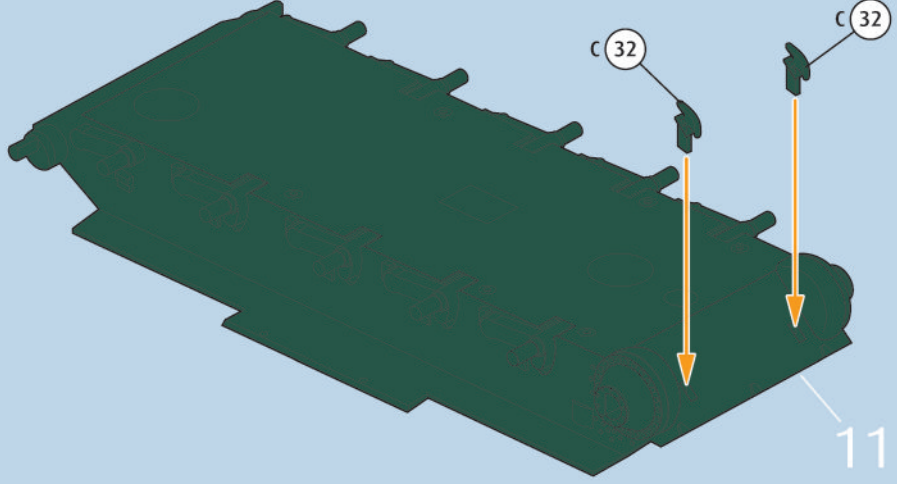

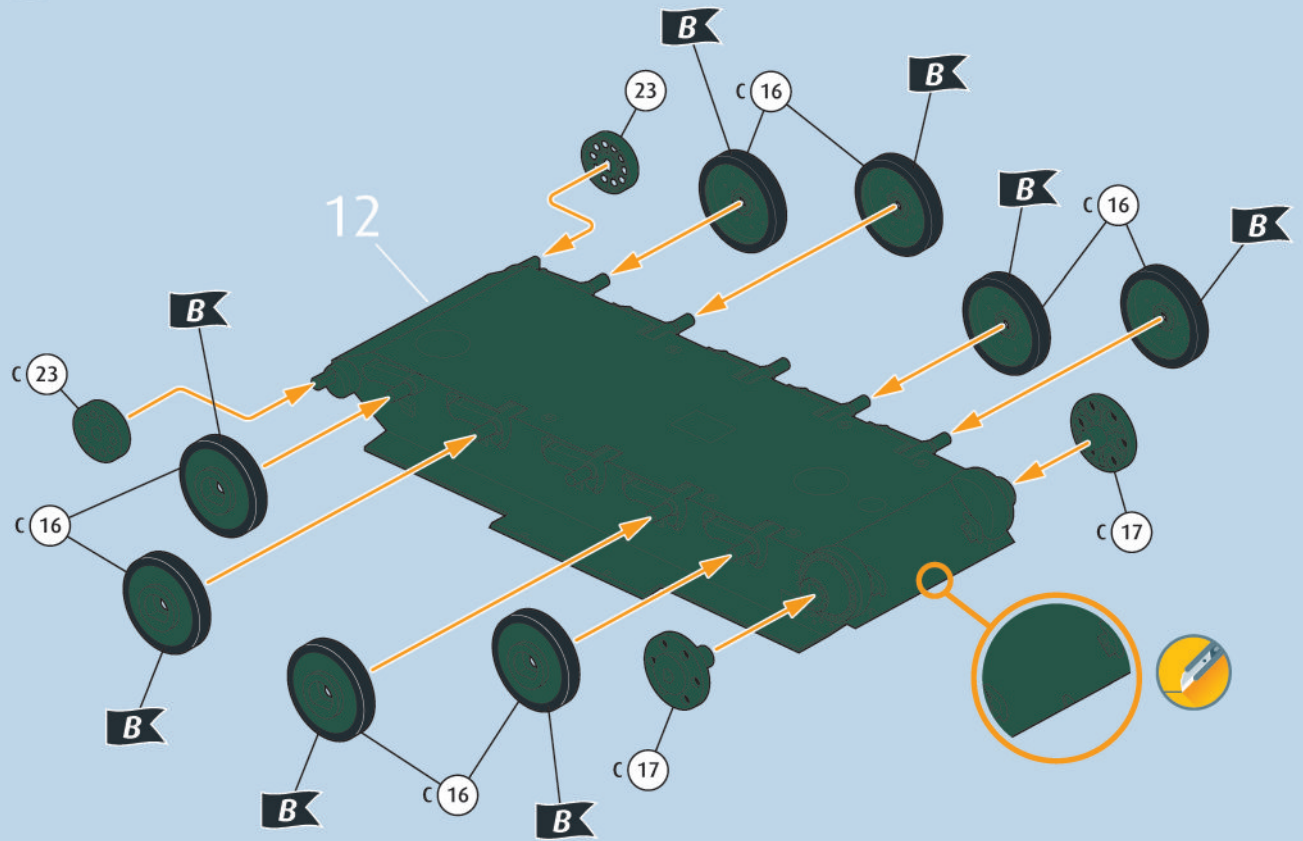
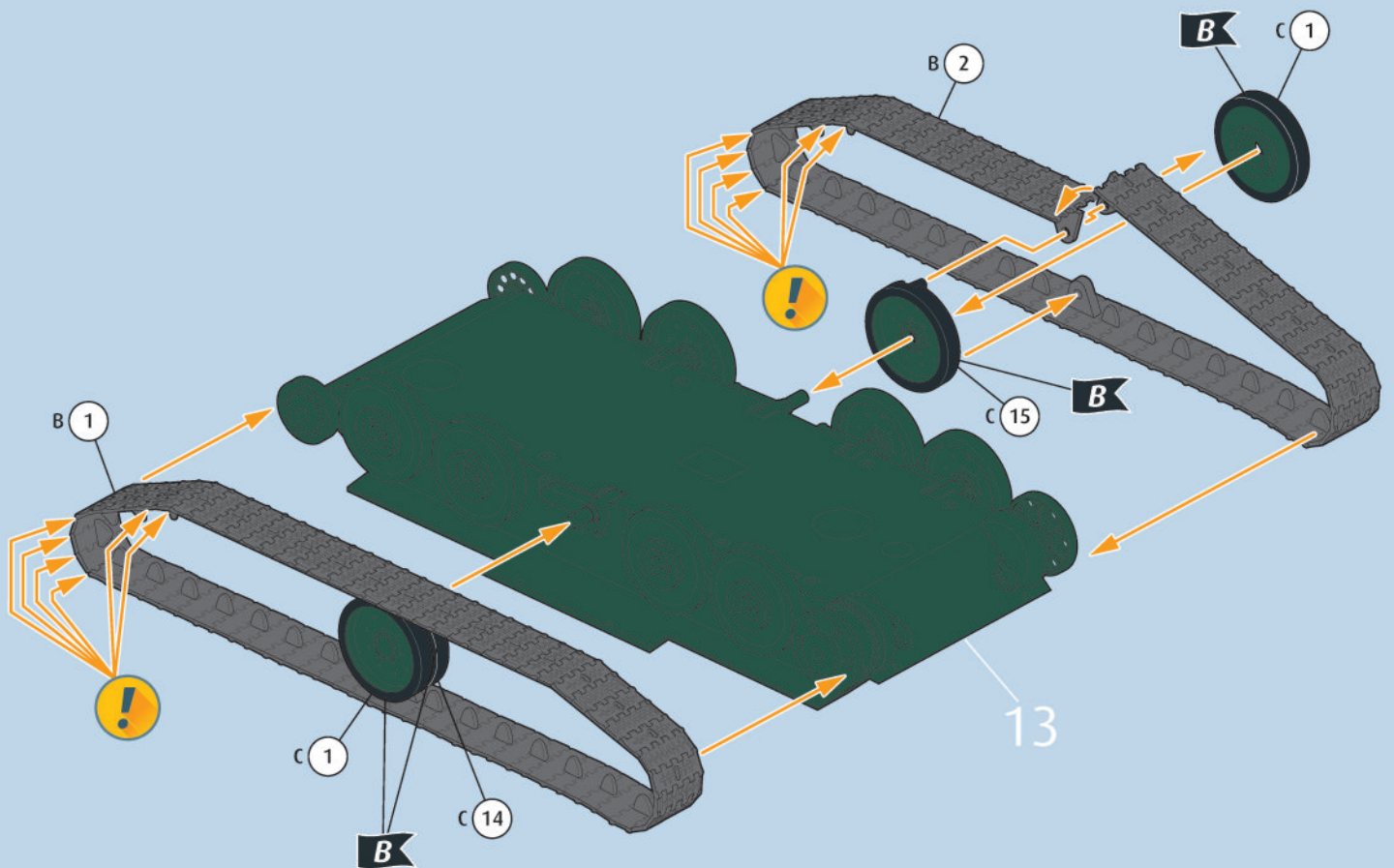
13 14 

15

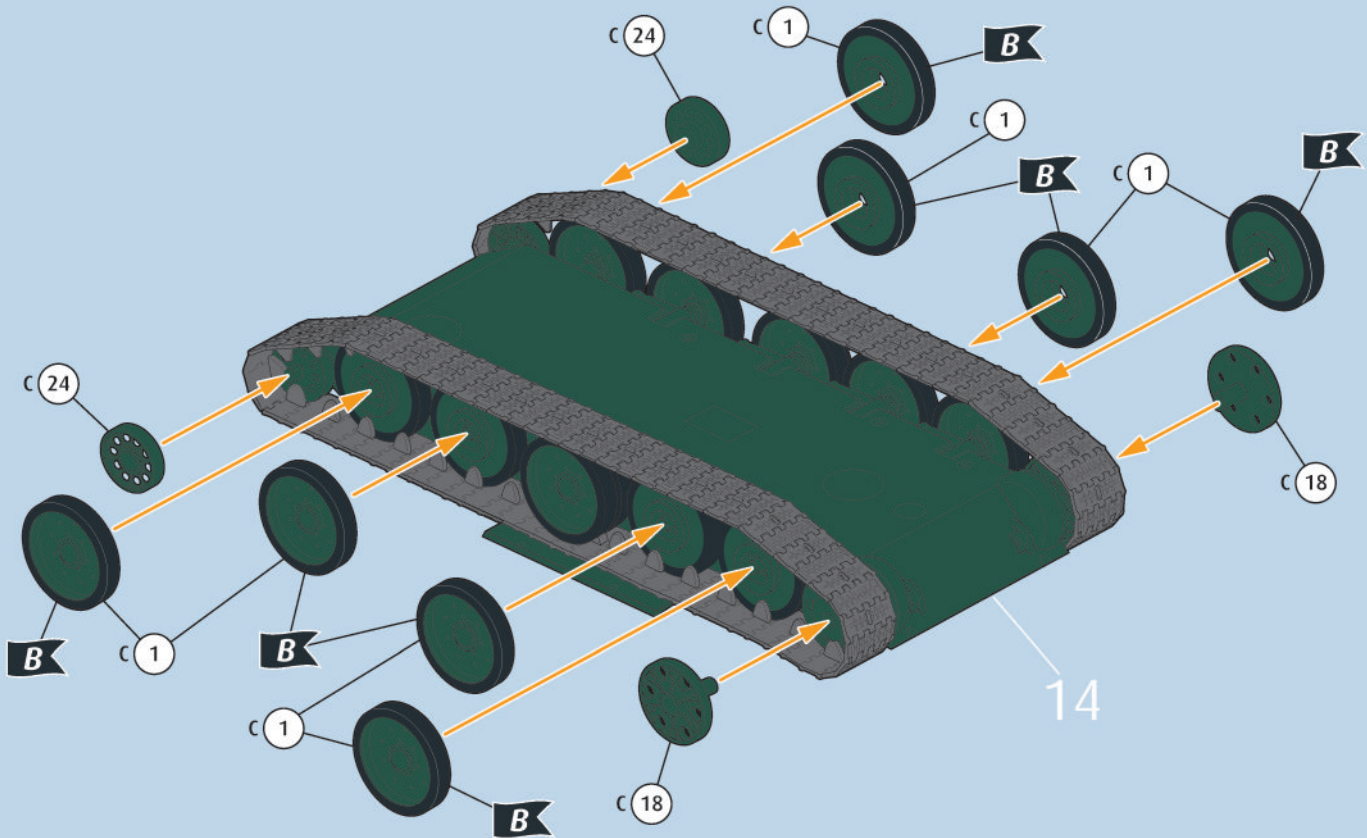

16

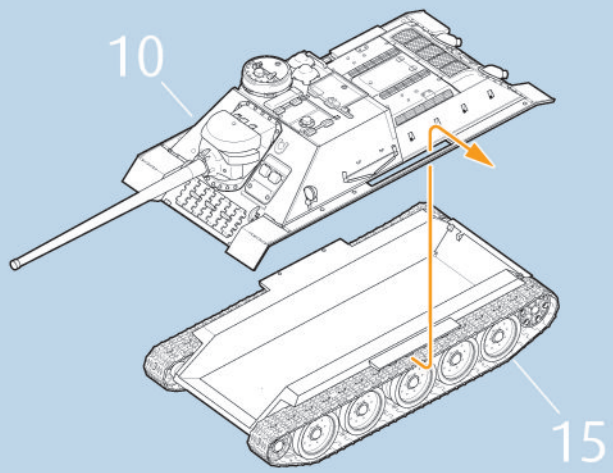

17

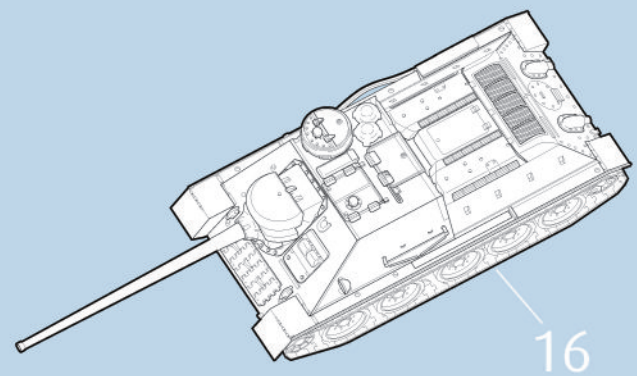

18

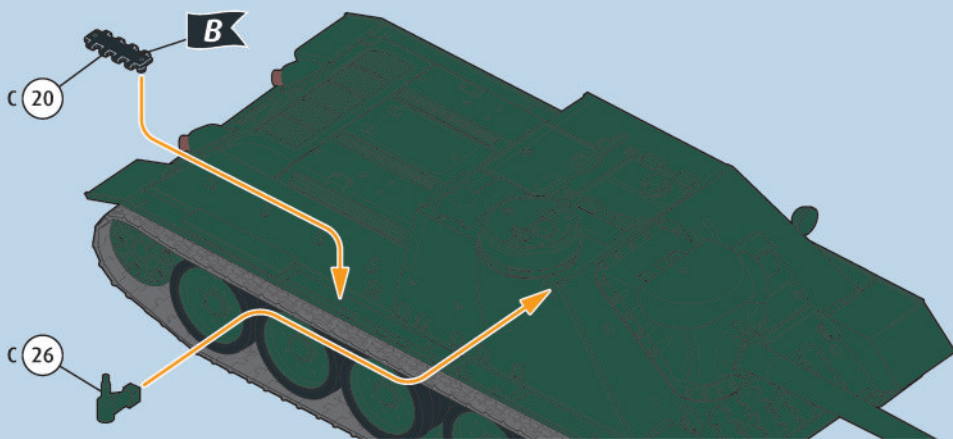

19 

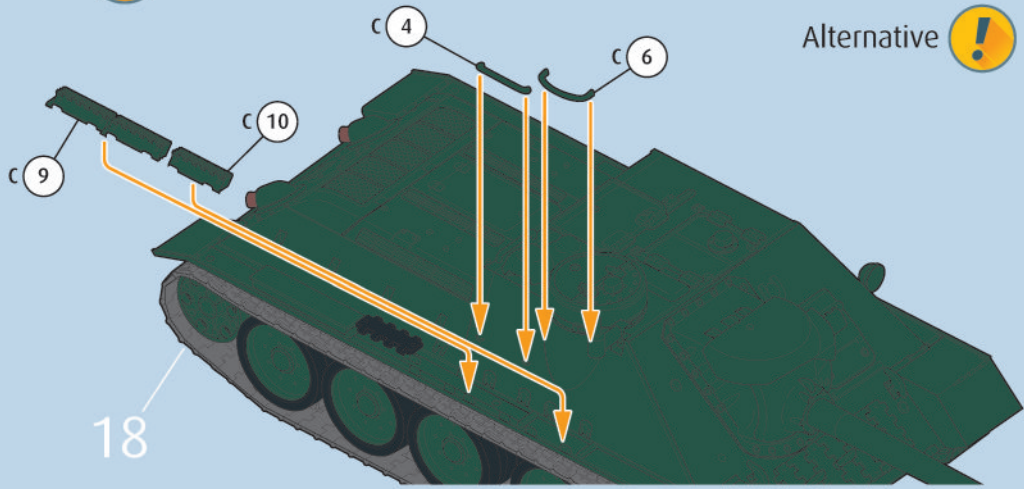

Alternative 

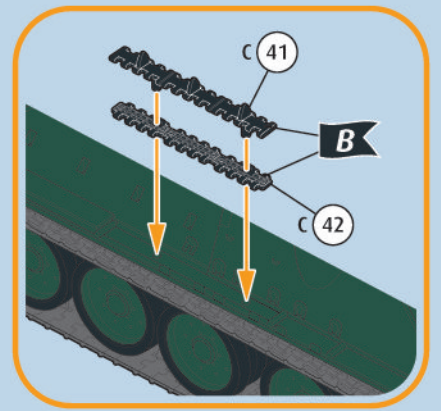

20  

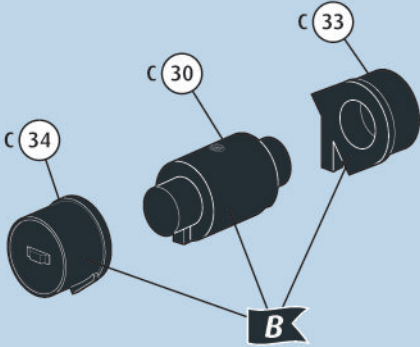

21 

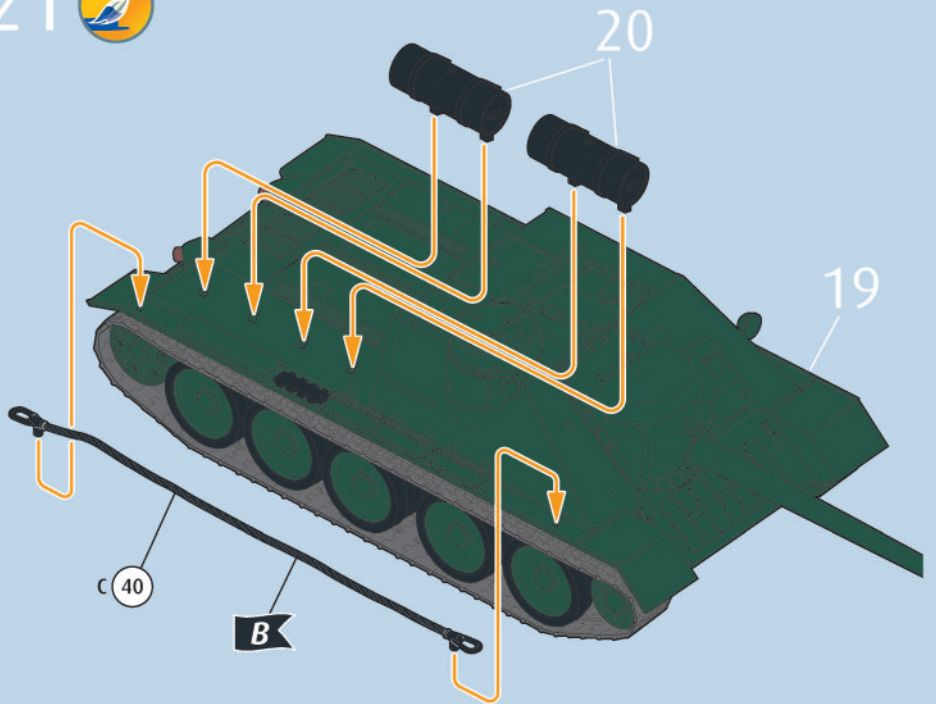

22 

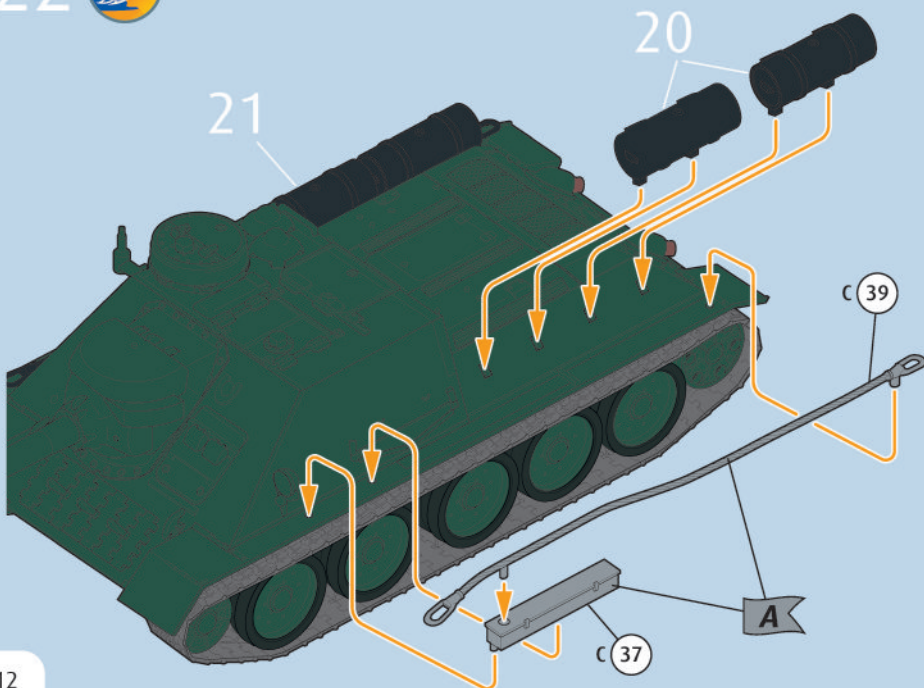

23 

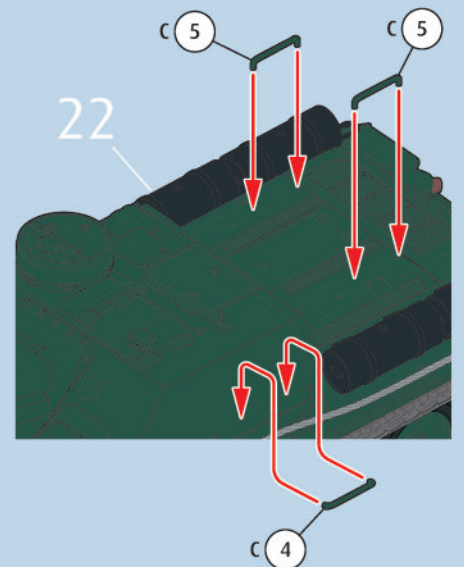

24



Su-100 Soviet Tank Destroyer

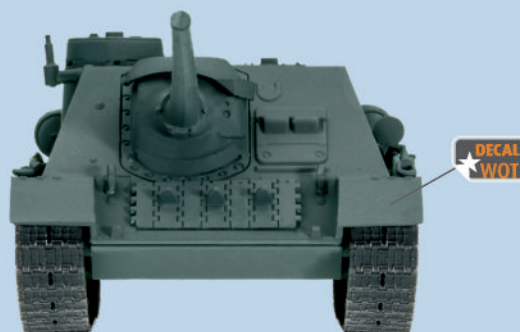
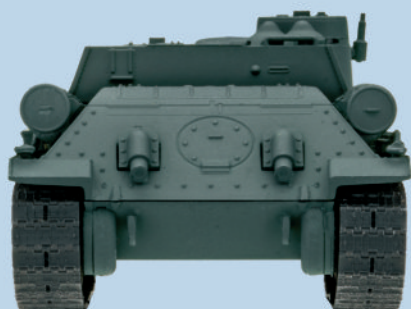
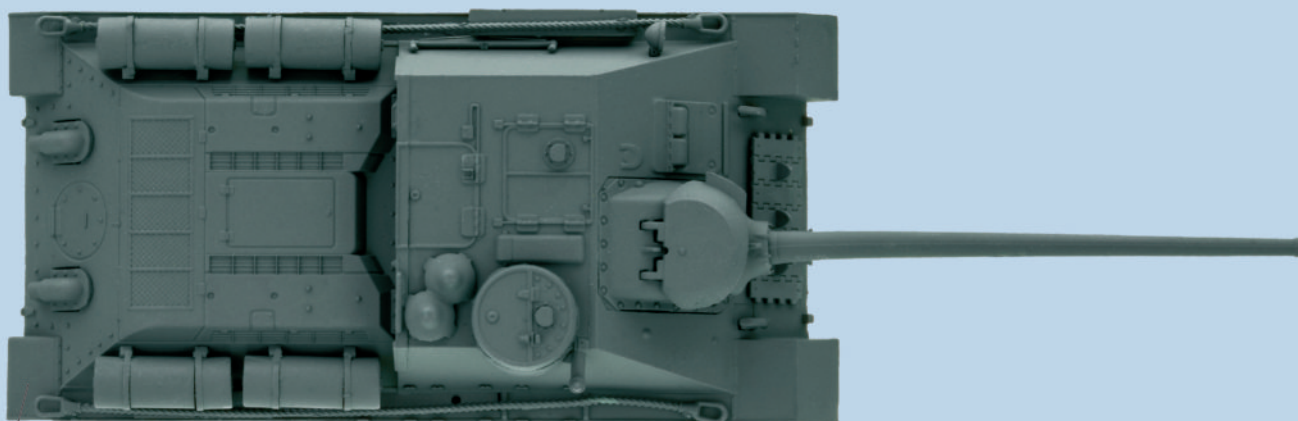







WORLD OF TANKS