

Revell



**JUNIOR
KIT**



1.



2.



3.



ERSATZTEILE BENÖTIGT?

Kein Problem. Einfach den Revell-Service mit Angabe von Artikel- und Teilenummer kontaktieren. Entweder unter service@revell.de oder Revell GmbH, Abteilung X, Henschelstr. 20-30, 32257 Bünde.*

*Wir bitten um Verständnis, dass eine Gewährleistung nur bei aktuellen Artikeln, die im Zeitraum der letzten 24 Monate erworben wurden, übernommen werden kann. Mit der Ersatzteil-Bestellung können Kosten z.B. für Verpackung und Versand entstehen. Ob diese Kosten anfallen wird im Vorfeld schriftlich durch unseren Service mitgeteilt. Das Angebot kann dann angenommen oder abgelehnt werden. Unfrei eingesandte Ersatzteil-Bestellungen werden von uns nicht angenommen! Dieser Direktservice gilt für die Länder Deutschland, Benelux, Österreich, Frankreich, Großbritannien. Ersatzteil-Bestellungen aus den übrigen Ländern werden über die jeweiligen Distributeure abgewickelt. Bitte kontaktieren Sie Ihren Händler.

NEED SPARE PARTS?

No problem. Contact Revell Service with the item number and part numbers you need: service@revell.de or Revell GmbH, Unit 10, Old Airfield Industrial Estate, Cheddington Lane, Tring, Herts, HP23 4QR, Great Britain.**

**We request your understanding that a warranty can only be accepted for current articles which have been purchased in the last 24 months. Orders for spare parts may also be subject to costs for packaging and shipping. You will be notified in advance by our Service department if such costs are incurred. The offer can then be accepted or rejected. We will not be able to process any postal requests unless correct postage has been applied to mailing! This direct service applies to the countries: Germany, Benelux, Austria, France, and the United Kingdom. Spare part orders from other countries are processed by the local distributors. Please contact your dealer.

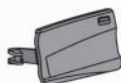
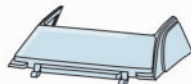

4 X



4 X



7 X



12 X



5 X



BESOIN DE PIÈCES DE RECHANGE ?

Il vous suffit de contacter le service Revell et d'indiquer la référence de l'article et de la pièce. Soit en écrivant par mail à france@revell.de (uniquement pour la France) ou par courrier à Revell GmbH, Département X, Henschelstr. 20-30, D-32257 Bünde.*

*La garantie s'applique pour les articles présents au catalogue et achetés au cours des 24 derniers mois. Merci de votre compréhension. La commande de pièces de rechange peut donner lieu à des frais supplémentaires, par ex. pour l'emballage et le port. Notre service client vous en informera au préalable par écrit. Vous pourrez accepter ou refuser le devis. Nous n'acceptons pas les commandes de pièces de rechange envoyées sans affranchissement ! Ce service direct est valable pour les pays suivants : Allemagne, Benelux, Autriche, France, Grande-Bretagne. Les commandes de pièces en provenance d'autres pays sont traitées par les distributeurs correspondants. Veuillez contacter votre revendeur.

HEBT U RESERVE-ONDERDELEN NODIG?

Geen probleem! Neem eenvoudig contact op met de klantenservice van Revell en geef ons het artikelen onderdeelnummer door. U kunt ons bereiken op service@revell.de of per post: Revell GmbH, Afdeling X, Henschelstr. 20-30, 32257 Bünde.*

*Wij vragen uw begrip voor de omstandigheid, dat er alleen garantie kan worden geboden voor actuele artikelen, die in de afgelopen 24 maanden zijn gekocht. Met het bestellen van reserveonderdelen kunnen kosten gemoed zijn, bijv. voor verpakking en verzending. U wordt vooraf schriftelijk door onze klantenservice op de hoogte gesteld als er kosten zouden ontstaan. Het aanbod kan dan worden aangenomen of afgewezen. Wij nemen geen ongefrankeerde bestellingen van reserveonderdelen aan! Deze rechtstreekse service wordt verleend in de landen Duitsland, de Benelux, Oostenrijk, Frankrijk en Groot-Brittannië. Bestellingen van reserveonderdelen in de overige landen worden afgewikkeld via de betreffende distributeurs. Neem hiervoor contact op met uw verkoper.

1.

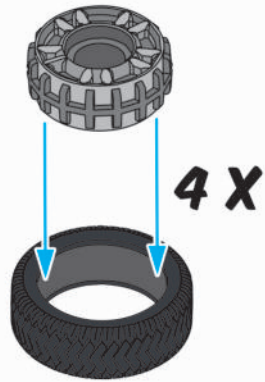
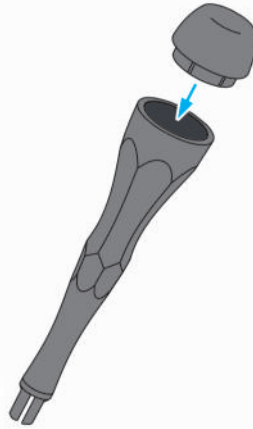

2.



4 X

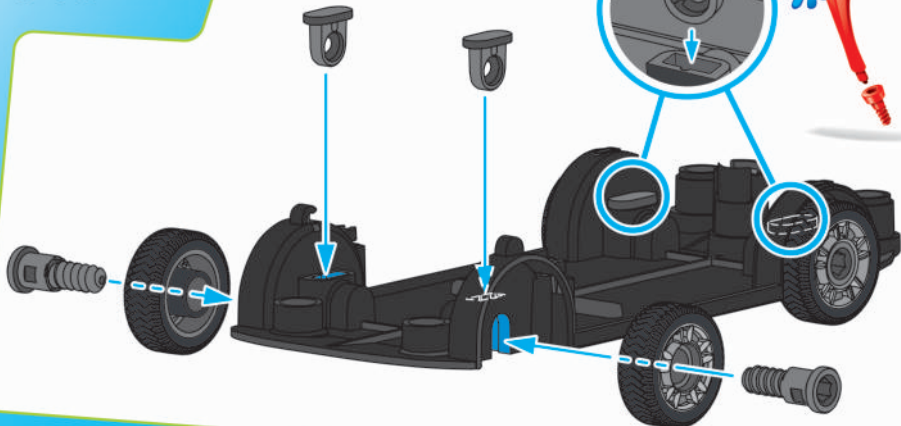

3.

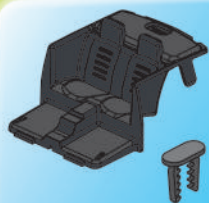

4.



2 X

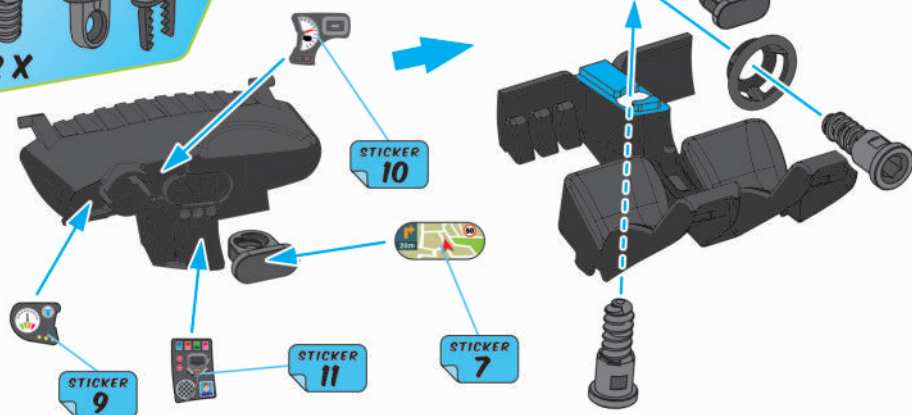

5.



CLICK!

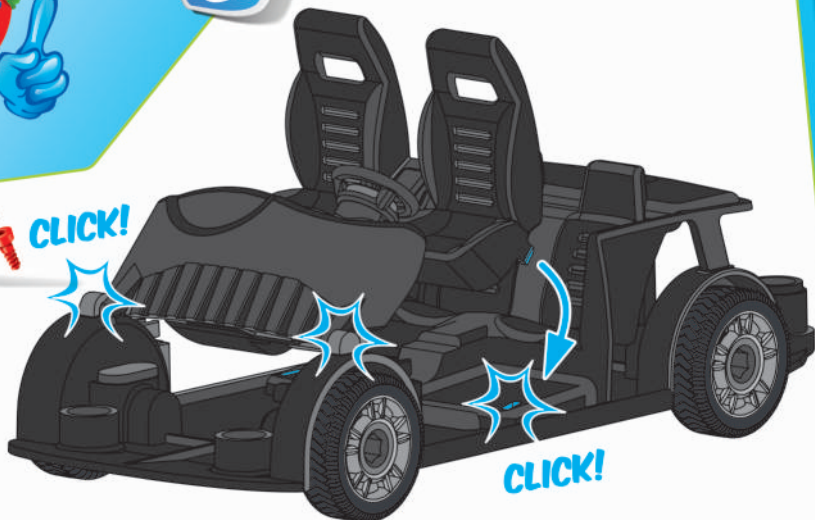

CLICK!

6.

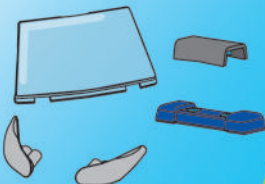

CLICK!

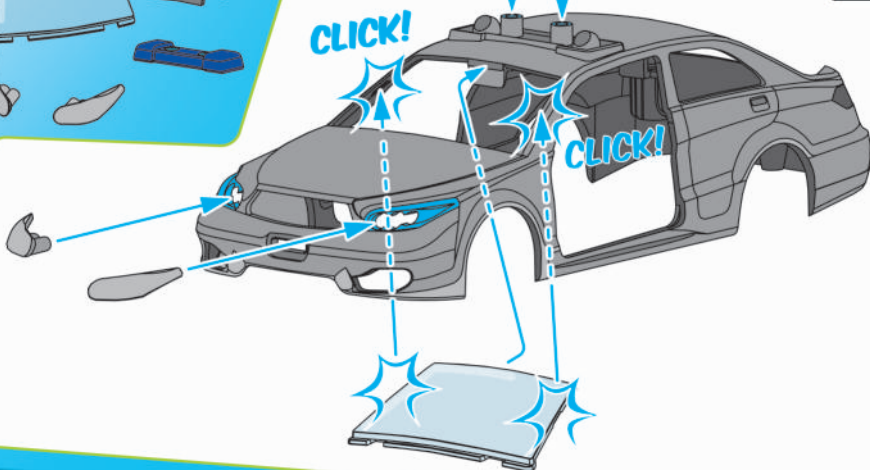

CLICK!

STICKER
18

7.

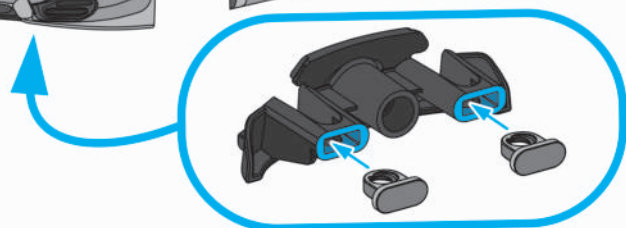

8.

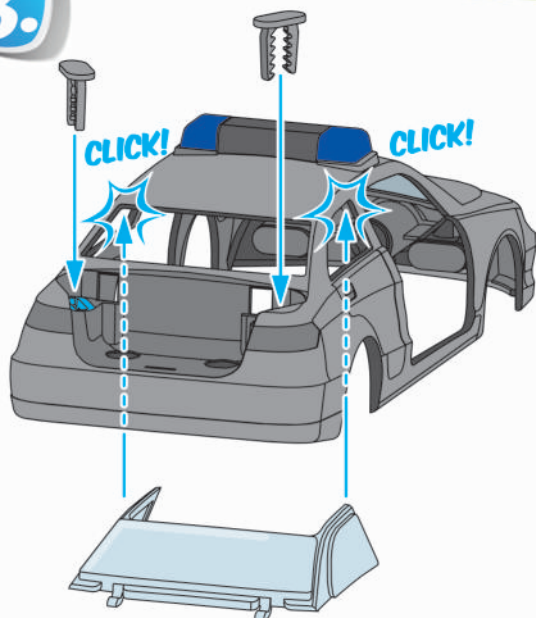
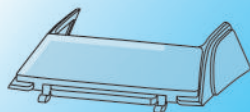

9.

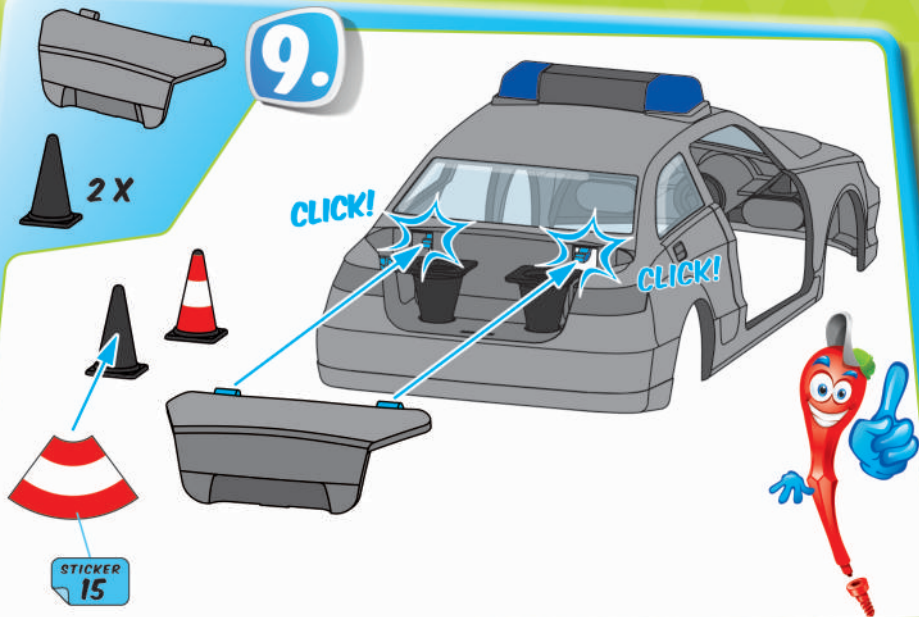

10.

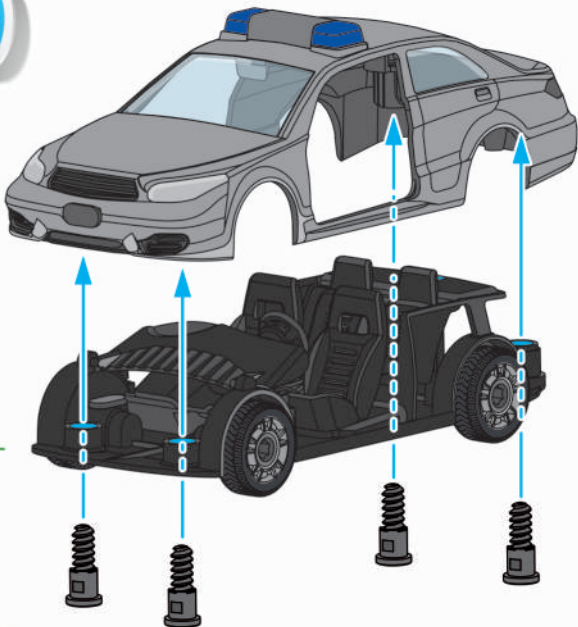

11.

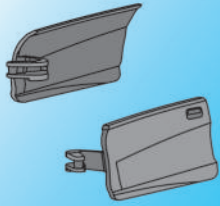

CLICK!

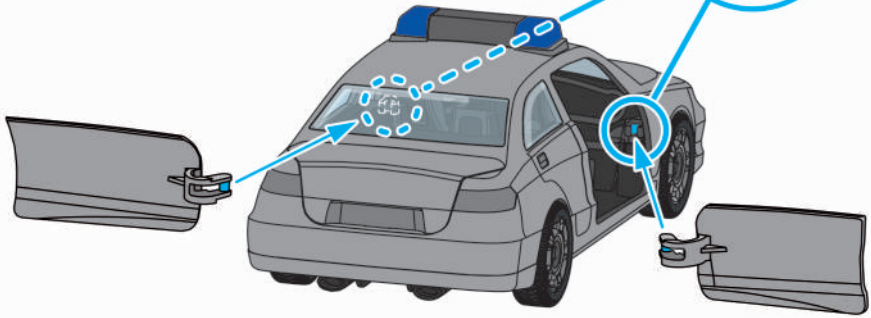

12.



REV-802

STICKER
12

OK!

13.

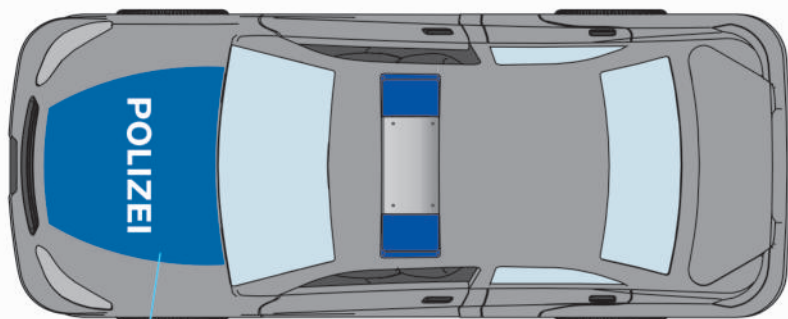
STICKER
1STICKER
2STICKER
3STICKER
4STICKER
5STICKER
6STICKER
14

14.

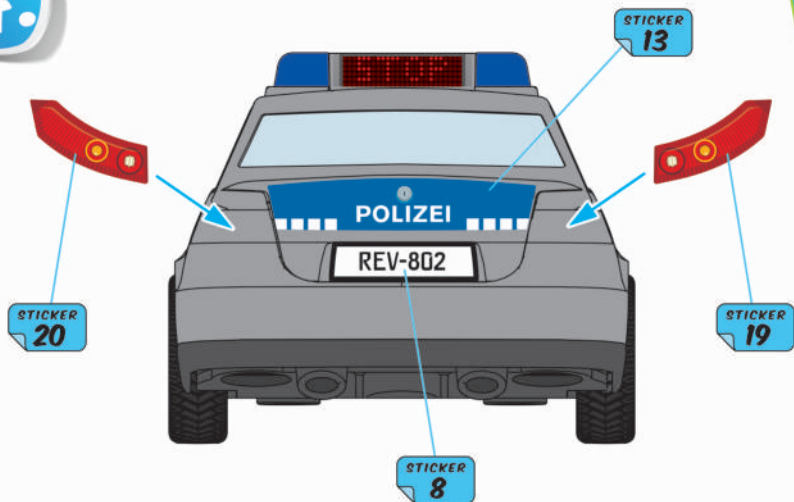

15.

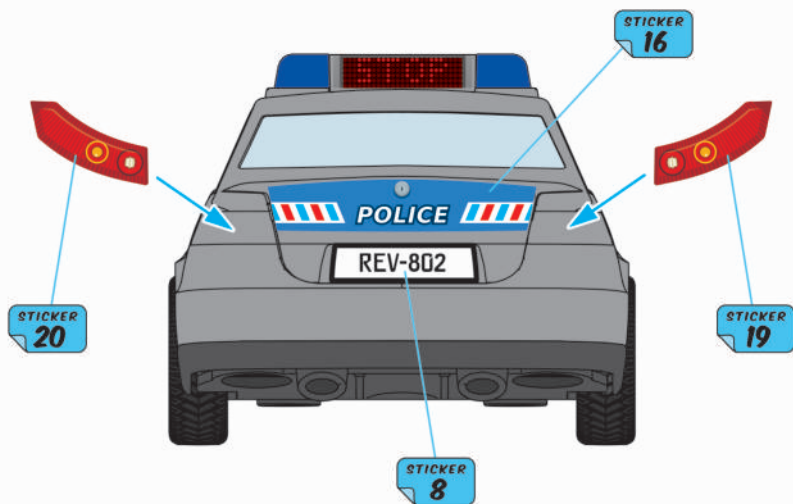

16.

