



01038-0379

easy-click system



RMS TITANIC

Beiliegenden Sicherheitstext beachten / Please note the enclosed safety advice

- Ⓢ Beiliegenden Sicherheitstext beachten und nachschlagbereit halten.
- Ⓢ Please note the enclosed safety advice and keep safe for later reference.
- Ⓢ Respecter les consignes de sécurité ci-jointes et les conserver à portée de main.
- Ⓢ Houdt u aan de bijgaande veiligheidsinstructies en hou deze steeds bij de hand.
- Ⓢ Seguire le avvertenze di sicurezza allegate e tenerle a portata di mano.
- Ⓢ Observar y siempre tener a disposición este texto de seguridad adjunto.
- Ⓢ Ter em atenção o texto de segurança anexo e guardá-lo para consulta.
- Ⓢ Overhold vedlagte sikkerhedsanvisninger og hav dem liggende i nærheden.
- Ⓢ Ha alltid vedlagt sikkerhetstekst klar til bruk.
- Ⓢ Beakta bifogad säkerhetstext och håll den i beredskap.
- Ⓢ Huomioi ja säilytä oheiset varoitukset.
- Ⓢ Соблюдать технику безопасности, сохранить инструкцию для дальнейших обращений.
- Ⓢ Przestrzegać załączonego tekstu dotyczącego bezpieczeństwa i mieć go zawsze pod ręką.
- Ⓢ Dodržujte tento příložený bezpečnostní text a mějte ho po ruce.
- Ⓢ A mellékelt biztonsági szöveget vegye figyelembe és tartsa fellepozásra készen.
- Ⓢ Respektujte příložený bezpečnostní text a uchovajte ho pre budúce použitie.
- Ⓢ Respectați textul de siguranță atașat și păstrați-l la îndemână.
- Ⓢ Спазвайте приложения текст за безопасност и го дръжте под ръка за справки.
- Ⓢ Priložena varnostna navodila izvajajte in jih hranite na vsem dostopnem mestu.
- Ⓢ Λάβετε υπόψη σας το συνημμένο κείμενο ασφαλείας και φυλάξτε το ώστε να ανατρέχετε σε αυτό όποτε χρειάζεται.
- Ⓢ Ektekiqüvenlik talimatlarını dikkate alıp, bakabileceğiniz bir şekilde muafaza ediniz.

© 2021 Revell GmbH, Henschelstr. 20-30, D-32257 Bünde.

REVELL IS THE REGISTERED TRADEMARK OF REVELL GMBH, GERMANY. www.revell.de

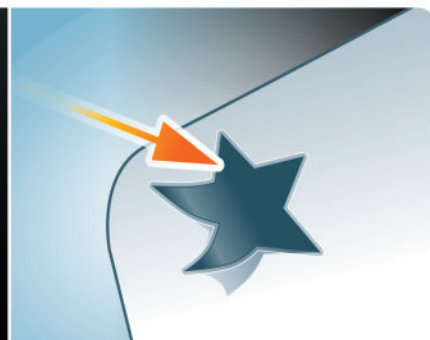
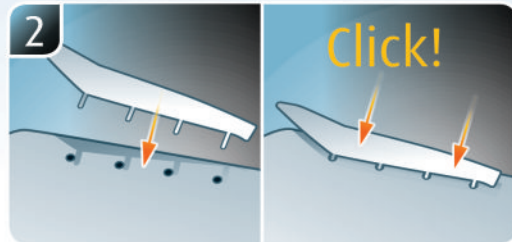

Painting

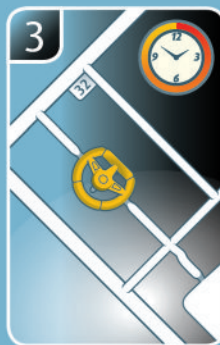

Decals

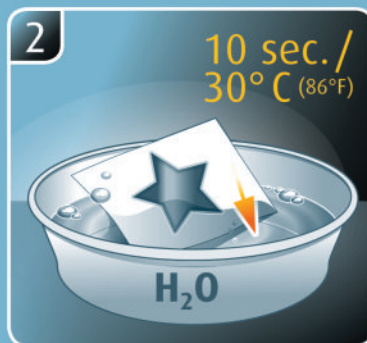
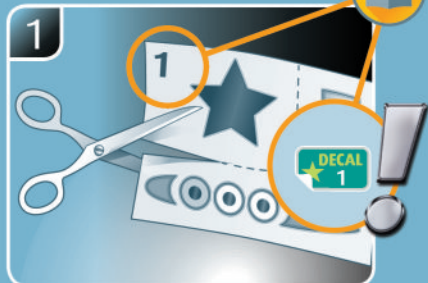

OPTIONAL • OPTIONAL • EN OPTION
OPTIONEEL • OPCIONAL • OPTIONAL *



(DE) Weitere Tipps und Tricks.
 (EN) Additional tips and tricks.
 (FR) Conseils et astuces supplémentaires.
 (NL) Andere tips en trucs.
 (IT) Ulteriori consigli e suggerimenti.
 (ES) Consejos y sugerencias adicionales.
 (PT) Mais dicas e truques.
 (SE) Flere tips og tricks.
 (NO) Flere tips og tricks.
 (SV) Ytterligare tips och tricks.
 (FI) Lisää vinkkejä ja niksejä.
 (RU) Другие советы и хитрости.

(PL) Dalsze wskazówki i sugestie.
 (CZ) Další tipy a rady.
 (HU) További ötletek és fogások.
 (SK) Ďalšie tipy a triky.
 (SE) Alte sfaturi și trucuri.
 (BG) Други полезни съвети и трикове.
 (SI) Nadaljnji nasveti in zvižaje.
 (GR) Πρόσθετες συμβουλές και κόλπα.
 (TR) Diğer öneriler ve ipuçları.

service@revell.de

* (PT) Opcional
 (SK) Valgfritt
 (NO) Valgfritt
 (SE) Övrigt
 (FI) Valinnainen
 (RU) Дополнительно
 (PL) Opcja
 (CZ) Volitelný krok

(HU) Opcióként
 (SK) Voliteľné
 (NO) Optionel
 (SE) Alternativ
 (FI) Lisävaruste
 (RU) Дополнительно
 (PL) Opcjonalnie
 (CZ) Opsiionel



- BE Bemalen
- EN Paint
- FR Peindre
- NL Beschilderen
- IT Colorare
- ES Pintar
- PT Pintar
- CS Mal
- NO Male
- SE Måla
- FI Maalaa
- RU Раскрасить
- PL Pomalować
- CZ Pomalovat
- HU Fesse be
- SK Natriet
- RO Vopsiți
- BG Боядисайте
- SI Pobarvajte
- HR Bájte
- TR Boyama



- DE Zusammenbau Reihenfolge.
- EN Sequence of assembly.
- FR Ordre d'assemblage.
- NL Volgorde van montage.
- IT Sequenza di assemblaggio.
- ES Secuencia de montaje.
- PT Sequência de montagem.
- CS Samlerækkefølge.
- NO Monteringsrekkefølge.
- SE Montering ordningsföljd.
- FI Kokoamisjärjestys.
- RU Последовательность сборки.
- PL Kolejność montażu.
- CZ Pořadí složení.
- HU Összerakási sorrend.
- SK Poradie zostavenia.
- RO Ordinea asamblării.
- BG Последователност на сглобяване.
- SI Vrstni red sestavljanja.
- HR Sériá topobétnosti.
- TR Parçaları birleştirme sırası.



- DE Anzahl der Arbeitsgänge.
- EN Number of working steps.
- FR Nombre d'étapes de travail.
- NL Het aantal bouwstappen.
- IT Numero di fasi di lavoro.
- ES Número de pasos de trabajo.
- PT Número de passos de trabalho.
- CS Antal arbejdsstrinn.
- NO Antall arbeidstrinn.
- SE Antal operationer.
- FI Työvaiheiden määrä.
- RU Количество операций.
- PL Liczba cykli roboczych.
- CZ Počet pracovních kroků.
- HU A munkamenetek száma.
- SK Počet pracovných operácií.
- RO Numărul etapelor de lucru.
- BG Брой работни стъпки.
- SI Število delovnih postopkov.
- HR Αριθμός βημάτων εργασίας.
- TR Çalışma adımı sayısı.



- DE Gleichen Vorgang auf der gegenüberliegenden Seite wiederholen.
- EN Repeat same procedure on opposite side.
- FR Opérer de la même façon sur l'autre face.
- NL Dezelfde handeling herhalen aan de tegenoverliggende kant.
- IT Ripetere il procedimento dall'altra parte.
- ES Repetir el mismo procedimiento en el lado contrario.
- PT Repetir alguns procedimentos no lado oposto.
- CS Gentag procedurén på den modstående side.
- NO Gjenta samme forløp på motliggende side.
- SE Upprepa samma process på motsatta sidan.
- FI Toista menettely vastakkaisella puolella.
- RU Повторить такие же действия на противоположной стороне.
- PL Powtórzć te same czynności po przeciwnej stronie.
- CZ Stejný postup opakujte na protilehlé straně.
- HU Ismétélje meg a műveletet az ellentétes oldalon.
- SK Rovnaký postup zopakujte na protiláhlej strane.
- RO Repetați același procedeu pe latura opusă.
- BG Повторете същите стъпки на срещуположната страна.
- SI Enak postopek ponovite na nasprotni strani.
- HR Επαναλάβετε την ίδια διαδικασία στην αντίθετη πλευρά.
- TR Aynı işlem adımlarını diğer tarafta da uygulayın.

OPTIONAL · OPTIONAL · EN OPTION · OPTIONEEL · OPCIONAL · OPTIONAL *

☞ Optional kann das Modell zusätzlich bemalt werden und wird damit zum ganz persönlichen Unikat. Wir empfehlen folgende Revell-Farben:

☞ The model can also be painted, which makes it completely unique. We recommend the following Revell paints:

☞ En option, il est aussi possible de peindre le modèle. Il devient alors une pièce vraiment unique et personnalisée. Nous vous recommandons les couleurs Revell suivantes :

☞ Optoneel kan het model aanvullend worden beschilderd om het een heel persoonlijke, unieke uitstraling te geven. Wij bevelen de volgende verf van Revell aan:

☞ Opcionalmente, el modelo se puede pintar para convertirlo en una pieza única personalizada. Recomendamos las siguientes pinturas de Revell:

☞ In via opzionale il modellino può essere verniciato per ottenere un esemplare del tutto personalizzato. Consigliamo di utilizzare i seguenti colori Revell:

☞ Opcionalmente, o modelo pode ser ainda pintado, dando-lhe um caráter pessoal único. Recomendamos as seguintes tintas Revell:

☞ Du kan vælge også at male modellen, som på den måde bliver personlig og unik. Vi anbefaler følgende Revell-farver:

☞ Du har mulighed til å gjøre modellen helt unik ved å male den. Vi anbefaler følgende Revell-farger:

☞ Modellen kan även målas och därmed bli en helt unik Unikat. Vi rekommenderar följande Revell-färger:

☞ Jos haluat yksilöllisen lopputuloksen, voit halutessasi myös maalata mallin. Suosittelemme käytämään seuraavia Revell-maaleja:

☞ В качестве дополнения модель может быть окрашена, что придаст ей персональные, уникальные черты. Мы рекомендуем следующие цвета Revell:

☞ Opcjonalnie można dodatkowo pomalować model, który dzięki temu będzie całkowicie osobistym unikatem. Polecamy następujące farby Revell:

☞ Model se může dodatečně pomalovat, čímž vznikne zcela jedinečný originál. Doporučujeme použít barvy značky Revell:

☞ Opcióként a modell kiegészítő festéssel is ellátható, így igazán egyedivé tehető. Ehhez a következő Revell festékeket ajánljuk:

☞ Model sa môže dodatočne pomalovať, čím vznikne celkom jedinečný originál. Odporúčame použiť tieto farby značky Revell:

☞ Opțional, pentru un aspect unic, personalizat, pe model se poate aplica un strat suplimentar de vopsea. Vă recomandăm următoarele vopsele Revell:

☞ Опционално моделът може допълнително да бъде изпълнен в друг цвят и да се превърне в абсолютен уникат. Препоръчваме следните цветове на Revell:

☞ Po želji je moguće model dodatno prebarviti in ga tako spremeniti v osebni unikat. Priporočamo naslednje barve Revell:

☞ Προαιρετικά μπορεί το μοντέλο να βαφεί και να γίνει ένα τελείως προσωπικό μοναδικό κομμάτι. Συνιστούμε τα παρακάτω χρώματα Revell:

☞ Opsiyonel olarak model boyanabilir ve benzersiz hale getirilebilir. Şu Revell renklerini tavsiye ediyoruz:

301

A

- ☞ Weiß seidenmatt
- ☞ White silk matt
- ☞ Blanc satiné mat
- ☞ Wit zijdemat
- ☞ Bianco opaco satinato
- ☞ Blanco mate satinado
- ☞ Branco mate sedoso
- ☞ Hvid silkematt
- ☞ Hvit silkematt
- ☞ Vit sidenmatt
- ☞ Valkoinen silkkimatta
- ☞ Белый шелковисто-матовый
- ☞ Biały jedwabiście matowy
- ☞ Bílá jemně matný
- ☞ Fehér, fakóselymes
- ☞ Biela hodvábné matný
- ☞ Alb satinat
- ☞ Бело коприненоматово
- ☞ Siva svilenomat
- ☞ Ασπρο σατινέ
- ☞ Beyaz ipeksi mat

374

B

- ☞ Grau seidenmatt
- ☞ Grey silk matt
- ☞ Gris satiné mat
- ☞ Grijs zijdemat
- ☞ Grigio opaco satinato
- ☞ Gris mate satinado
- ☞ Cinzento mate sedoso
- ☞ Grå silkematt
- ☞ Grå silkematt
- ☞ Grå sidenmatt
- ☞ Harmaa silkkimatta
- ☞ Серый шелковисто-матовый
- ☞ Szary jedwabiście matowy
- ☞ Šedá jemně matný
- ☞ Szürke, fakóselymes
- ☞ Sivá hodvábné matný
- ☞ Gri satinat
- ☞ Сиво коприненоматово
- ☞ Siva svilenomat
- ☞ Γκρι σατινέ
- ☞ Gri ipeksi mat

91

C

- ☞ Eisen metallic
- ☞ Iron metallic
- ☞ Fer métallique
- ☞ IJzer metallic
- ☞ Ferro metallico
- ☞ Acero metálico
- ☞ Aço metálico
- ☞ Stål metallisk
- ☞ Jern metallic
- ☞ Stål metallic
- ☞ Teräs metallinen
- ☞ Сталь металлик
- ☞ Grafit metaliczny
- ☞ Ocelová metalizovaný
- ☞ Acélmetál
- ☞ Ocelová metaliza
- ☞ Fier metallic
- ☞ Железо металик
- ☞ Żelazna kovinska
- ☞ Χρώμα σιδήρου μεταλλικό
- ☞ Metalik metalik

92

D

- ☞ Messing metallic
- ☞ Brass metallic
- ☞ Laiton métallique
- ☞ Messing metallic
- ☞ Ottone metallico
- ☞ Latón metálico
- ☞ Latão metálico
- ☞ Messing metallisk
- ☞ Messing metallic
- ☞ Mässing metallic
- ☞ Messinki metallinen
- ☞ Латунь металлик
- ☞ Mosiądz metaliczny
- ☞ Mosazná metalizovaný
- ☞ Sárgaréz metal
- ☞ Mosadzna metaliza
- ☞ Alámiu metallic
- ☞ Месинг металик
- ☞ Medeninasta kovinska
- ☞ Χρώμα ορειχάλκου μεταλλικό
- ☞ Piring rengi metalik

378

E

- ☞ Dunkelgrau seidenmatt
- ☞ Dark grey silk matt
- ☞ Gris foncé satiné mat
- ☞ Donkergrijs zijdemat
- ☞ Grigio scuro opaco satinato
- ☞ Gris oscuro mate satinado
- ☞ Cinza escuro mate sedoso
- ☞ Mørkegrå silkematt
- ☞ Mørk grå silkematt
- ☞ Mørkgrå sidenmatt
- ☞ Tummanharmaa silkkimatta
- ☞ Темно-серый шелковисто-матовый
- ☞ Ciemnoszary jedwabiście matowy
- ☞ Tmavá šedá jemně matný
- ☞ Sötétszürke, fakóselymes
- ☞ Tmavo sivá hodvábné matný
- ☞ Gri-inchis satinat
- ☞ Тъмносиво коприненоматово
- ☞ Tmno-siva svilenomat
- ☞ Γκρι σκούρο σατινέ
- ☞ Koyu gri ipeksi mat

* ☞ Opcional
☞ Valgfritt
☞ Valgfritt

☞ Övrigt
☞ Valinnainen
☞ Дополнительно

☞ Opcja
☞ Voliteľný krok
☞ Opcióként

☞ Voliteľné
☞ Opțional
☞ Опция

☞ Dodatno
☞ Προαιρετικά
☞ Opsiyonel

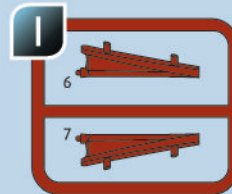
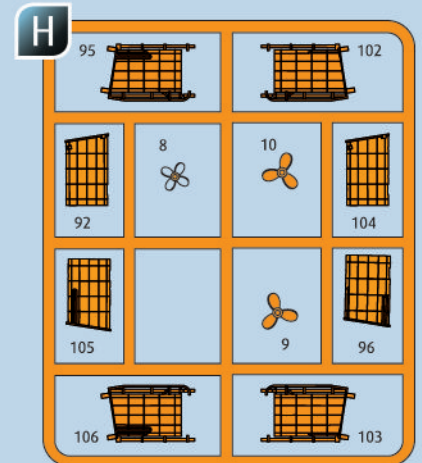
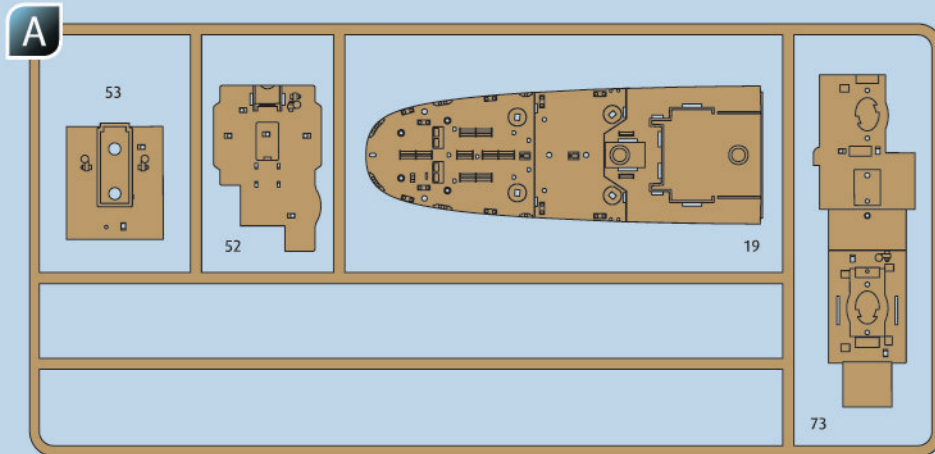
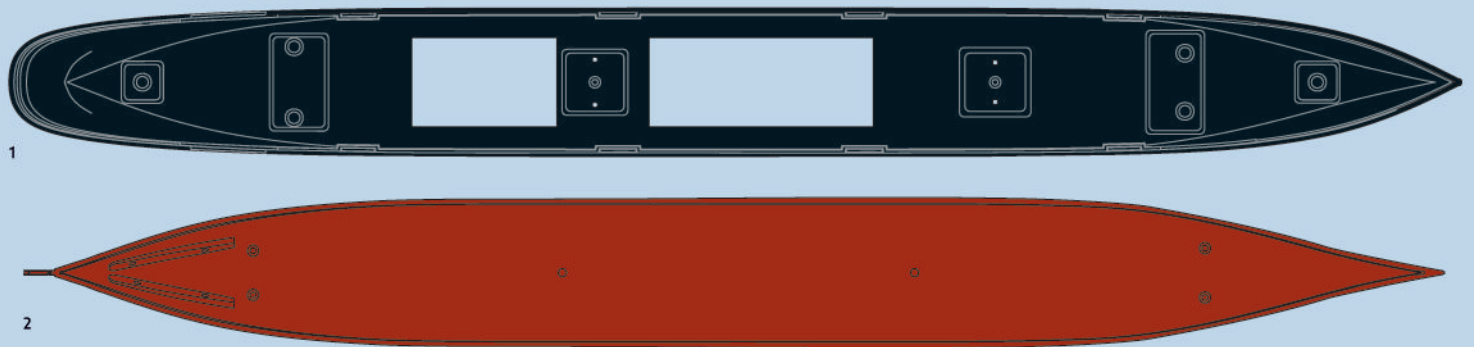

☉ Kundenservice: www.revell-service.de oder **Revell GmbH, Abteilung X, Henschelstr. 20-30, D-32257 Bünde** (nur für DE, AT, NL, BE, LU, ES, IT, PL, US, CA). Für alle übrigen Länder kontaktieren Sie ausschließlich Ihren Händler oder Distributeur.

☉ Customer Service: www.revell-service.de/en or **Carrera Revell UK LTD, Unit 10, Old Airfield Industrial Estate, Cheddington Lane, Tring HP23 4QR, United Kingdom** (only for United Kingdom and Ireland). For all other countries please contact your dealer or distributor only.

☉ Customer Service: www.revell-service.de/en or **Revell GmbH, Department X, Henschelstr. 20-30, D-32257 Bünde, Germany** (only for DE, AT, NL, BE, LU, ES, IT, PL, US, CA). For all other countries please contact your dealer or distributor only.

☉ Service clientèle: www.revell-service.de/fr (uniquement pour la France). Pour tous les autres pays, veuillez contacter votre revendeur ou distributeur uniquement.

☉ Klantenservice: www.revell-service.de of **Revell GmbH, Abteilung X, Henschelstr. 20-30, D-32257 Bünde** (alleen voor DE, AT, NL, BE, LU, ES, IT, PL, US, CA). Voor alle andere landen kunt u alleen contact opnemen met uw dealer of distributeur.

☉ Servicio al cliente: www.revell-service.de o **Revell GmbH, Abteilung X, Henschelstr. 20-30, D-32257 Bünde** (sólo para DE, AT, NL, BE, LU, ES, IT, PL, US, CA). Para todos los demás países, por favor, póngase en contacto con su proveedor o distribuidor solamente.

☉ Servizio clienti: www.revell-service.de o **Revell GmbH, Abteilung X, Henschelstr. 20-30, D-32257 Bünde** (solo per DE, AT, NL, BE, LU, ES, IT, PL, US, CA). Per tutti gli altri paesi si prega di contattare esclusivamente il proprio rivenditore o distributore.

☉ Serviço de apoio ao cliente: www.revell-service.de ou **Revell GmbH, Abteilung X, Henschelstr. 20-30, D-32257 Bünde** (apenas para DE, AT, NL, BE, LU, ES, IT, PL, US, CA). Para todos os outros países, contacte apenas o seu revendedor ou distribuidor.

☉ Kundenservice: www.revell-service.de eller **Revell GmbH, Abteilung X, Henschelstr. 20-30, D-32257 Bünde** (kun for DE, AT, NL, BE, LU, ES, IT, PL, US, CA). For alle øvrige lande bedes du udelukkende kontakte din forhandler eller distributor.

☉ Kundenservice: www.revell-service.de eller **Revell GmbH, Abteilung X, Henschelstr. 20-30, D-32257 Bünde** (kun for DE, AT, NL, BE, LU, ES, IT, PL, US, CA). For alle andre land gjelder at all kontakt skal skje via din forhandler eller distributør.

☉ Kundtjänst: www.revell-service.de eller **Revell GmbH, Abteilung X, Henschelstr. 20-30, D-32257 Bünde** (endast för DE, AT, NL, BE, LU, ES, IT, PL, US, CA). För övriga länder var god kontakta återförsäljaren eller distributören.

☉ Asiakaspalvelu: www.revell-service.de tai **Revell GmbH, Abteilung X, Henschelstr. 20-30, D-32257 Bünde** (vain DE, AT, NL, BE, LU, ES, IT, PL, US, CA). Muiden maiden kohdalla ota yhteyttä paikalliseen jälleenmyyjään tai jakelijaan.

☉ Служба поддержки клиентов: www.revell-service.de или **Revell GmbH, Abteilung X, Henschelstr. 20-30, D-32257 Bünde** (только для DE, AT, NL, BE, LU, ES, IT, PL, US, CA). Клиентам из других стран следует обращаться исключительно к своему поставщику или дистрибьютору.

☉ Dział obsługi klienta: www.revell-service.de lub **Revell GmbH, Abteilung X, Henschelstr. 20-30, D-32257 Bünde** (tylko dla DE, AT, NL, BE, LU, ES, IT, PL, US, CA). We wszystkich pozostałych krajach należy kontaktować się wyłącznie ze sprzedawcą lub dystrybutorem.

☉ Zákaznický servis: www.revell-service.de nebo **Revell GmbH, Abteilung X, Henschelstr. 20-30, D-32257 Bünde** (pouze pro DE, AT, NL, BE, LU, ES, IT, PL, US, CA). Pro všechny ostatní země kontaktujte výlučně svého obchodníka nebo prodejce.

☉ Ügyfélszolgálat: www.revell-service.de vagy **Revell GmbH, Abteilung X, Henschelstr. 20-30, D-32257 Bünde** (csak DE, AT, NL, BE, LU, ES, IT, PL, US, CA országok esetében). Az egyéb országok esetének kizárólag kereskedőjével, vagy forgalmazójával vegye fel a kapcsolatot.

☉ Zákaznický servis: www.revell-service.de alebo **Revell GmbH, Abteilung X, Henschelstr. 20-30, D-32257 Bünde** (iba pre DE, AT, NL, BE, LU, ES, IT, PL, US, CA). Pre všetky ostatné krajiny kontaktujte výlučne svojho obchodníka alebo predajcu.

☉ Serviciul clienți www.revell-service.de sau **Revell GmbH, Abteilung X, Henschelstr. 20-30, D-32257 Bünde** (doar pentru DE, AT, NL, BE, LU, ES, IT, PL, US, CA). Pentru toate celelalte țări contactați doar comerciantul dvs. sau distribuitorul.

☉ Отдел за обслужване на клиенти: www.revell-service.de или **Revell GmbH, Abteilung X, Henschelstr. 20-30, D-32257 Bünde** (само за DE, AT, NL, BE, LU, ES, IT, PL, US, CA). За всички останали държави се свързвайте само с Вашия дилър или дистрибутор.

☉ Služba za pomoć strankam: www.revell-service.de ali **Revell GmbH, Abteilung X, Henschelstr. 20-30, D-32257 Bünde** (samo za DE, AT, NL, BE, LU, ES, IT, PL, US, CA). Za vse ostale države se obrnite samo na prodajalca ali distributerja.

☉ Τμήμα εξυπηρέτησης πελατών: www.revell-service.de ή **Revell GmbH, Abteilung X, Henschelstr. 20-30, D-32257 Bünde** (μόνο για DE, AT, NL, BE, LU, ES, IT, PL, US, CA). Για όλες τις άλλες χώρες επικοινωνήστε αποκλειστικά με τον έμπορο ή τον αντιπρόσωπο της περιοχής σας.

☉ Müşteri hizmetleri: www.revell-service.de veya **Revell GmbH, Abteilung X, Henschelstr. 20-30, D-32257 Bünde** (sadece DE, AT, NL, BE, LU, ES, IT, PL, ABD, CA için). Tüm diğer ülkeler için sadece satıcınıza veya distribütörünüze başvurun.

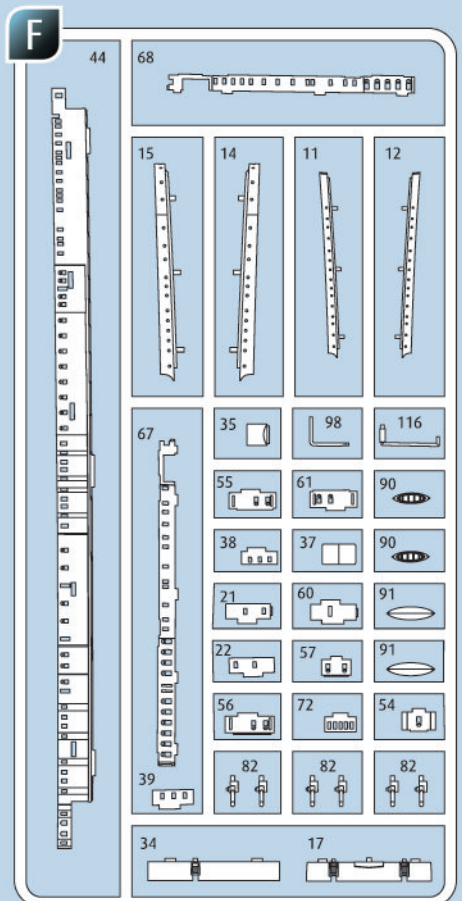
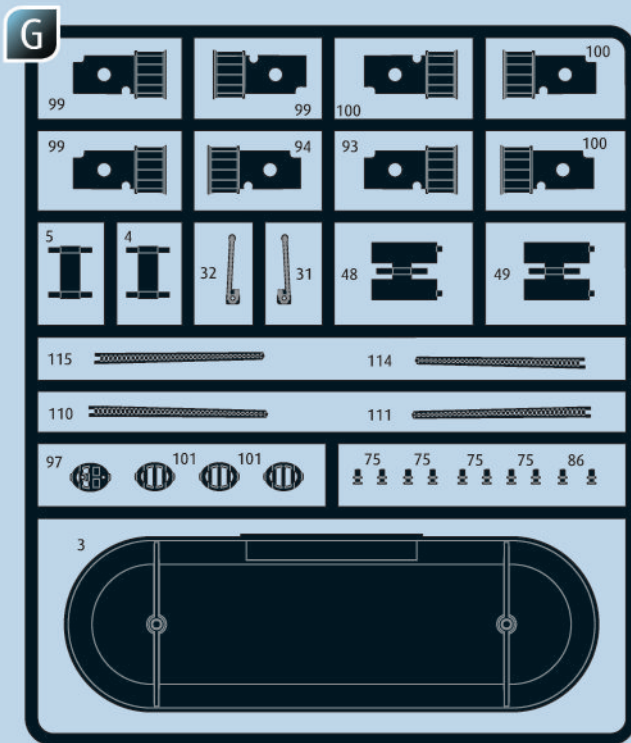
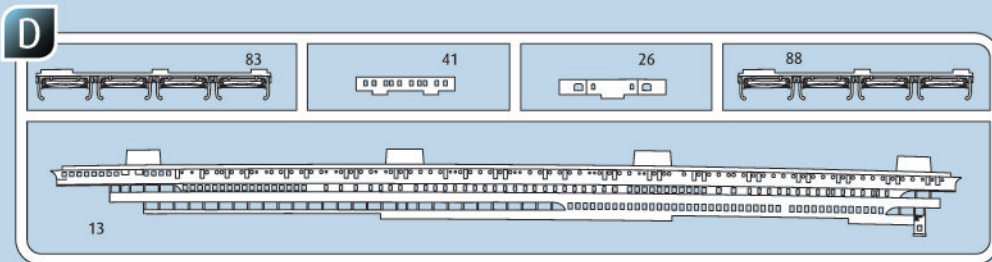
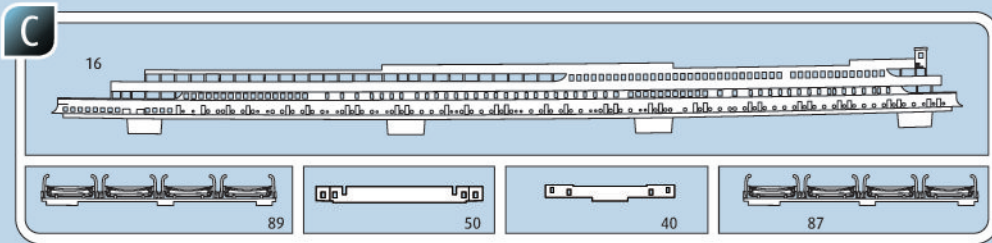
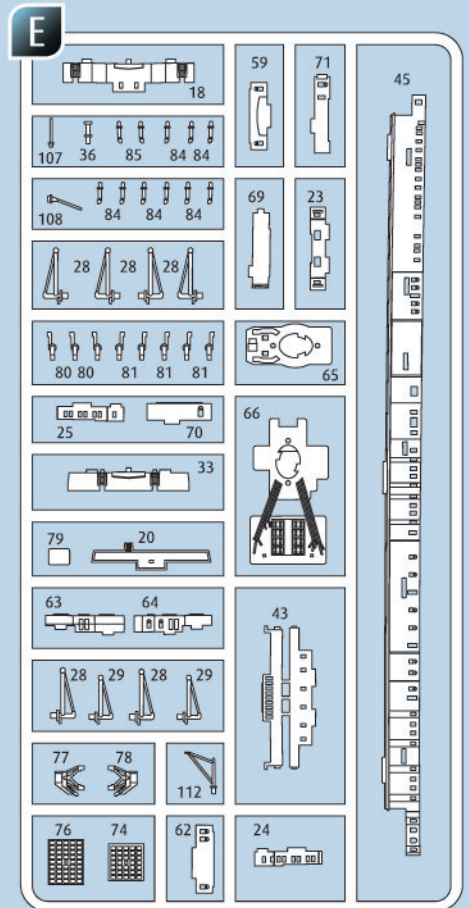
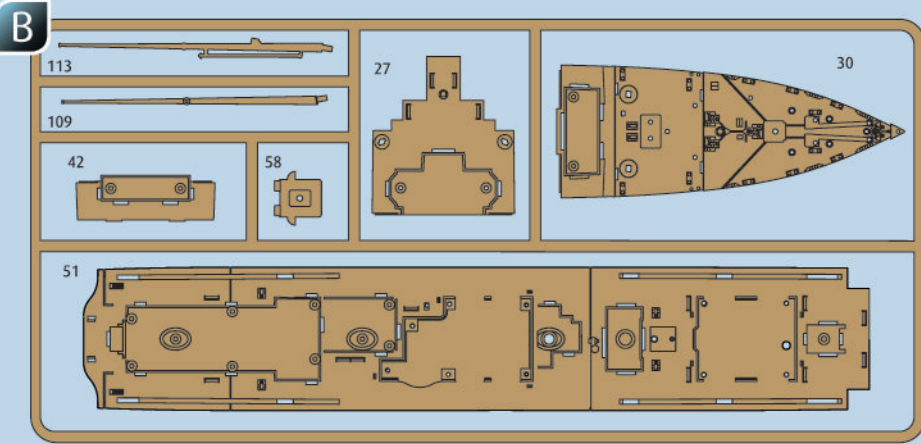

1

DOOR 7

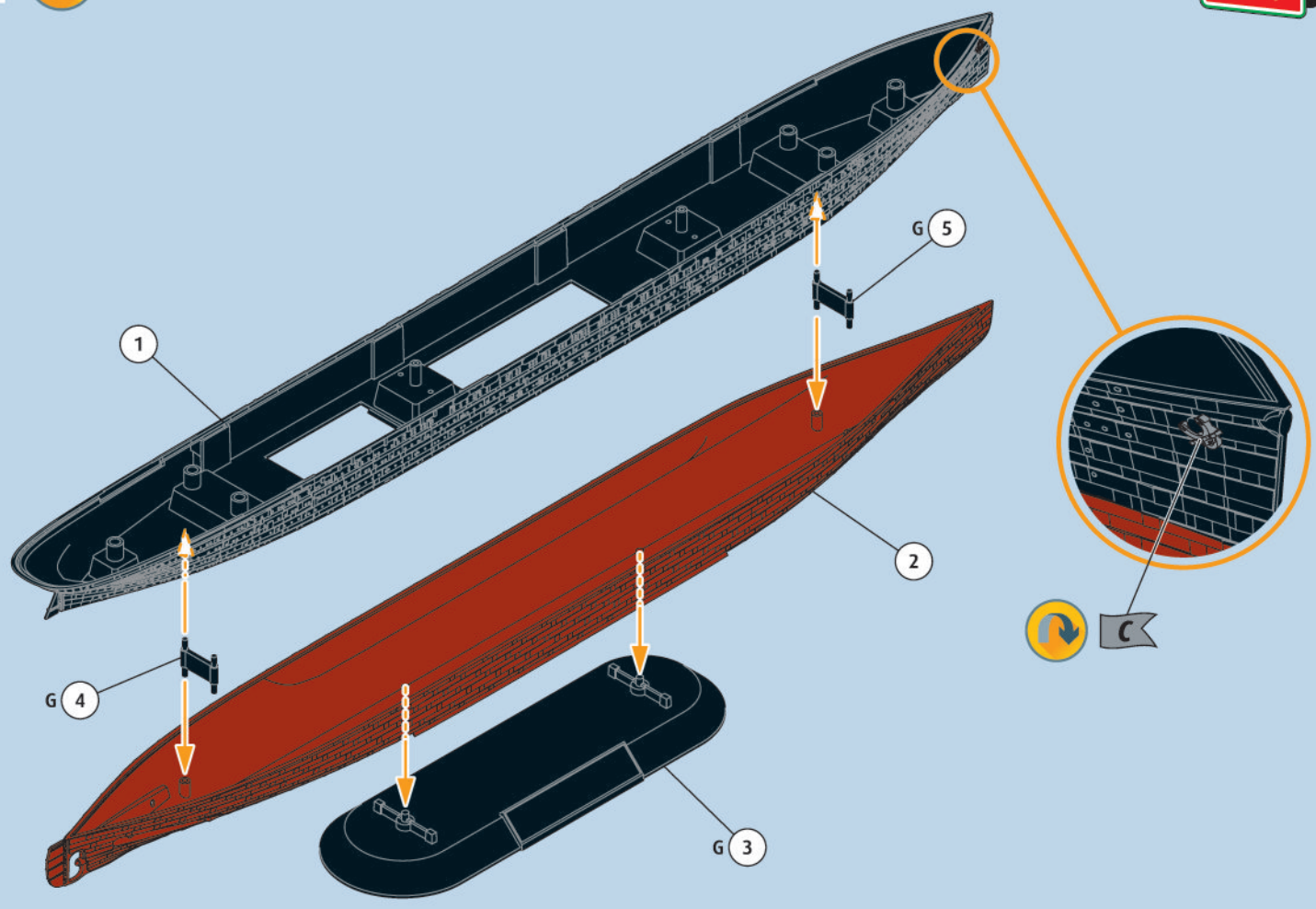

2

DOOR 10

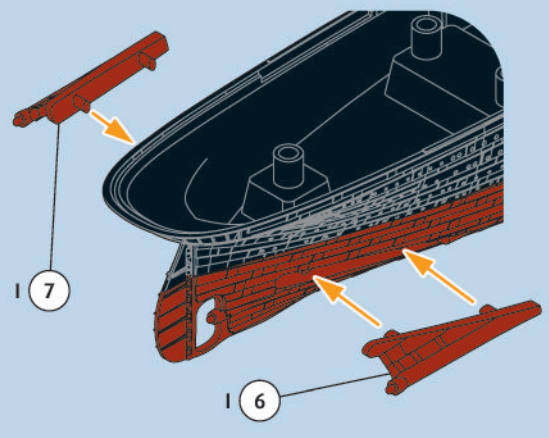

3

DOOR 12

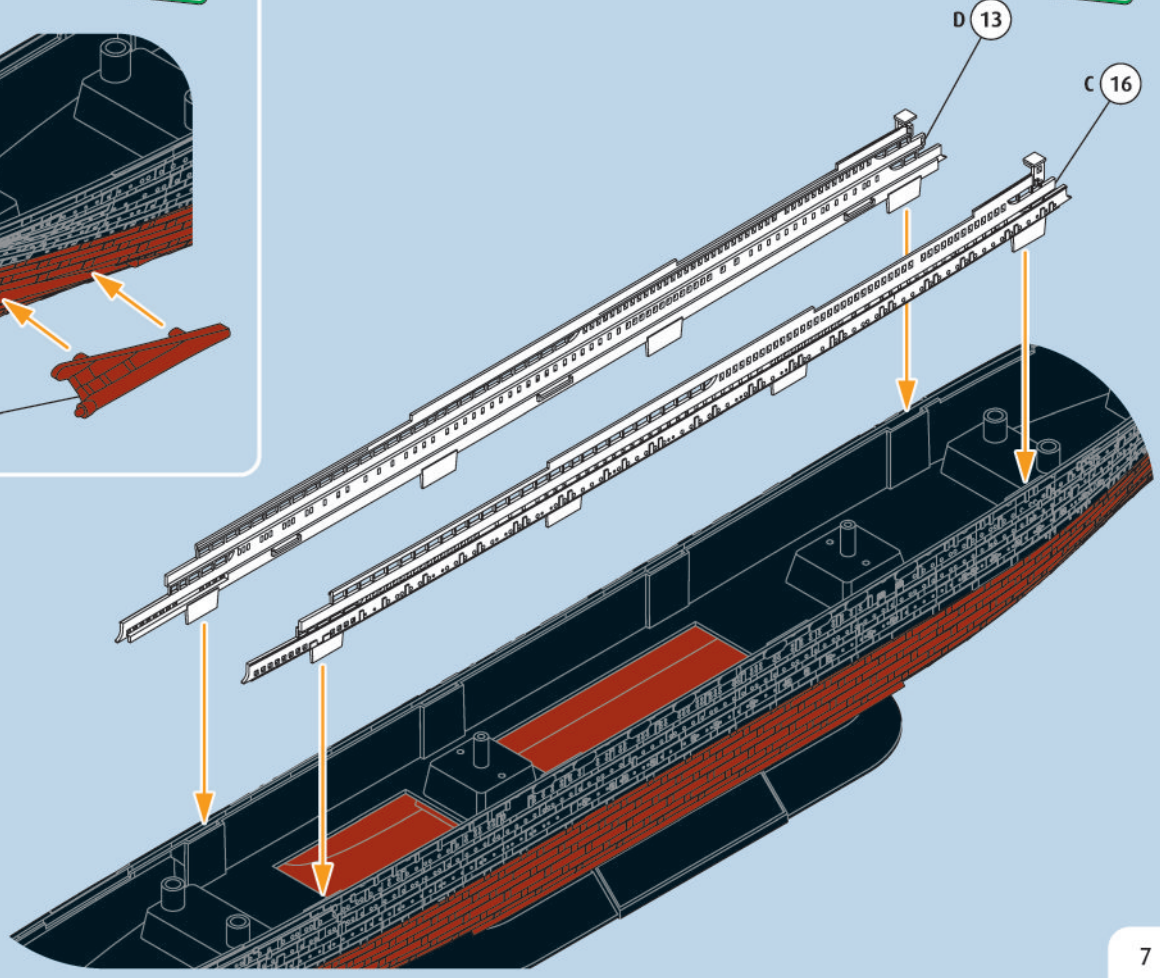

4 

DOOR 15

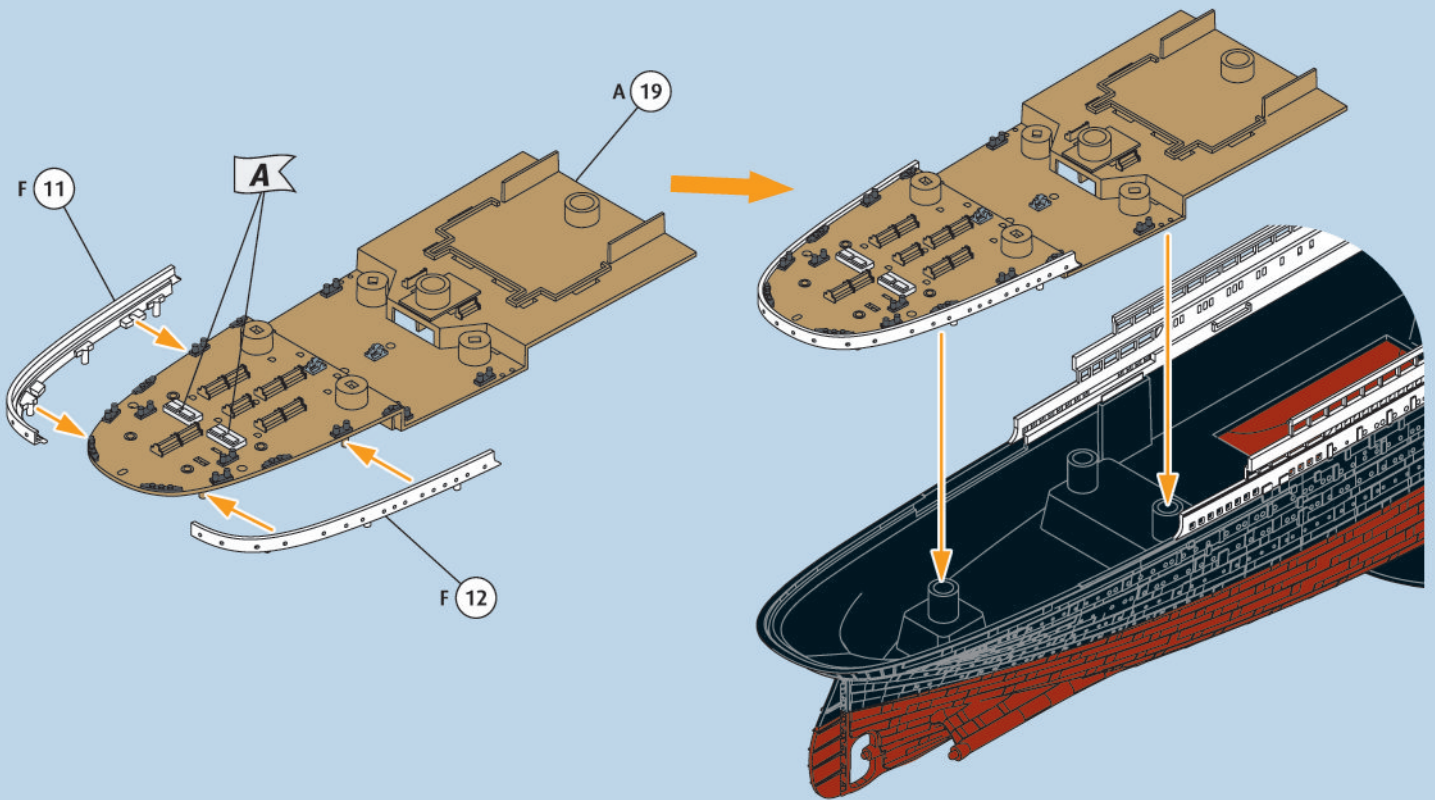

5

DOOR 16

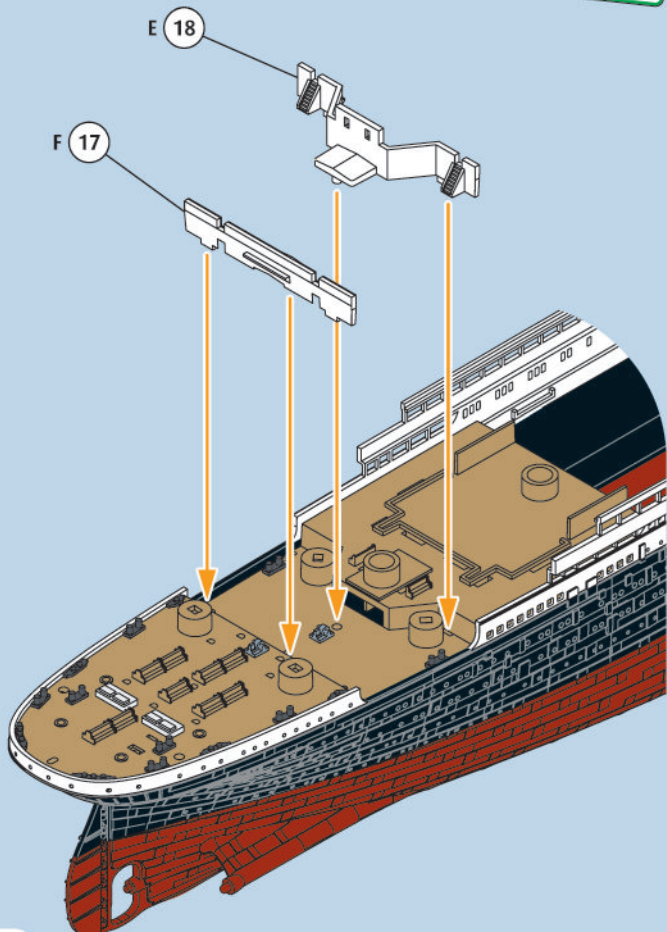

6

DOOR 18

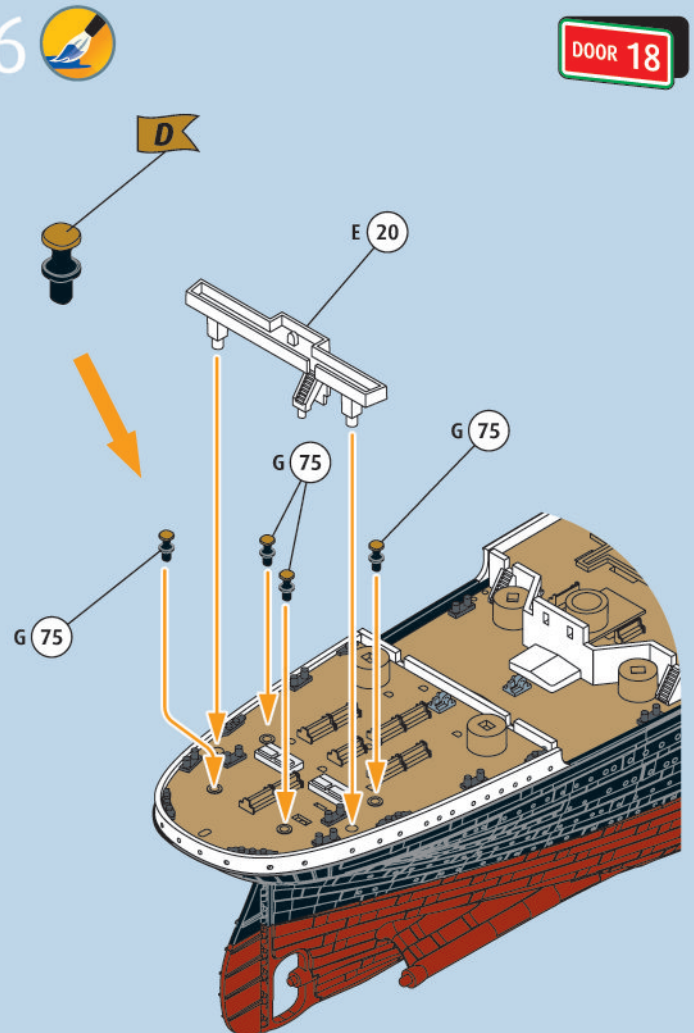

7

DOOR 18

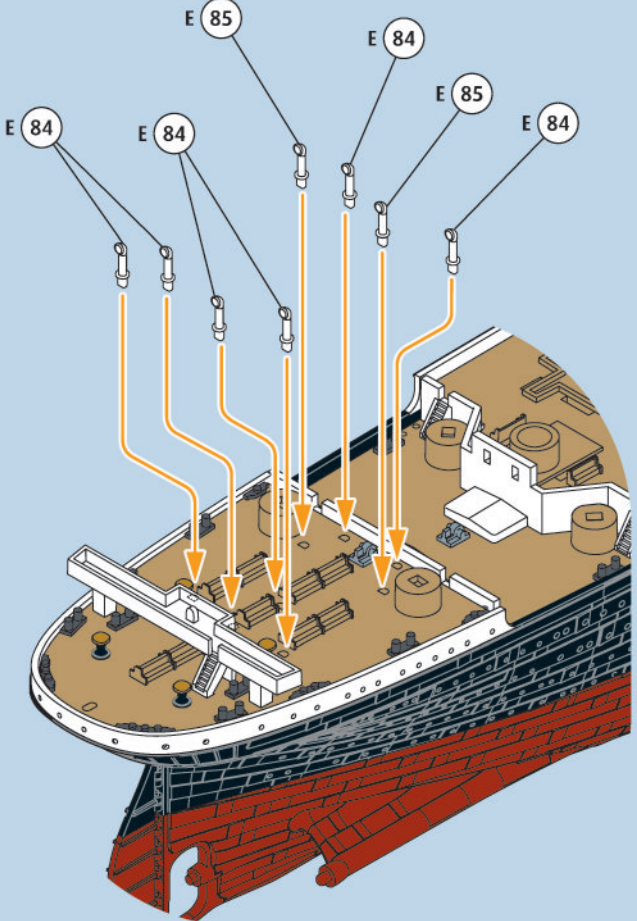

8

DOOR 18

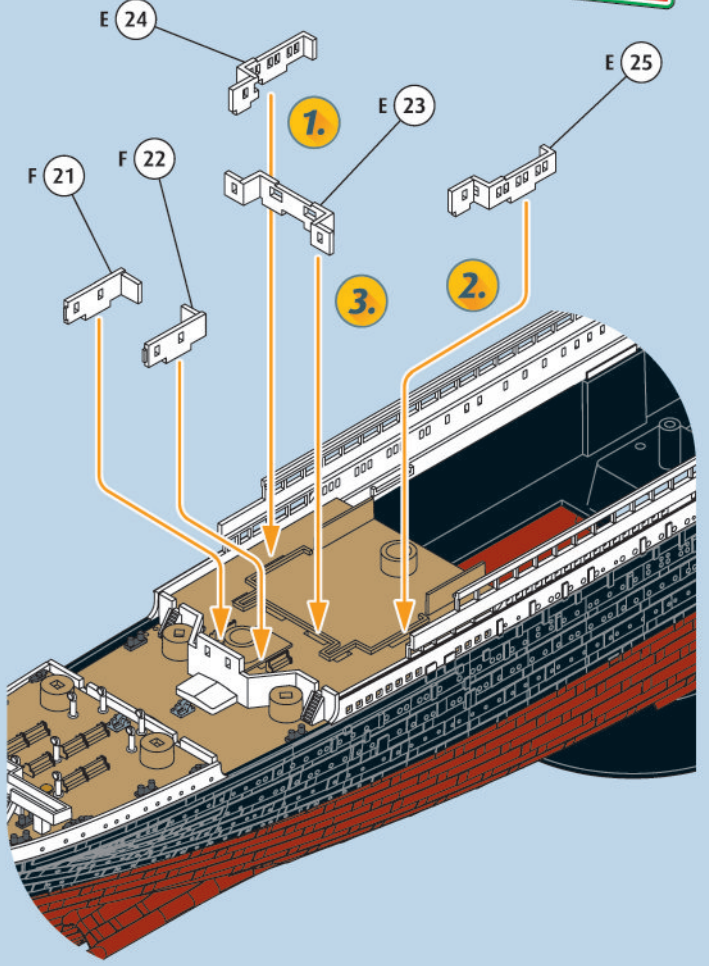

9

DOOR 19

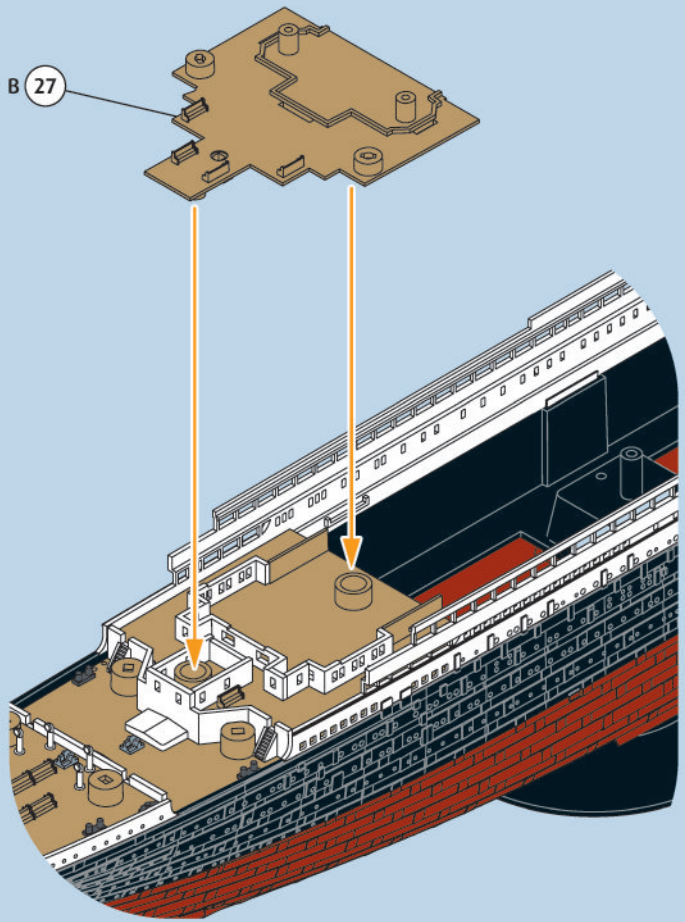

10

DOOR 21

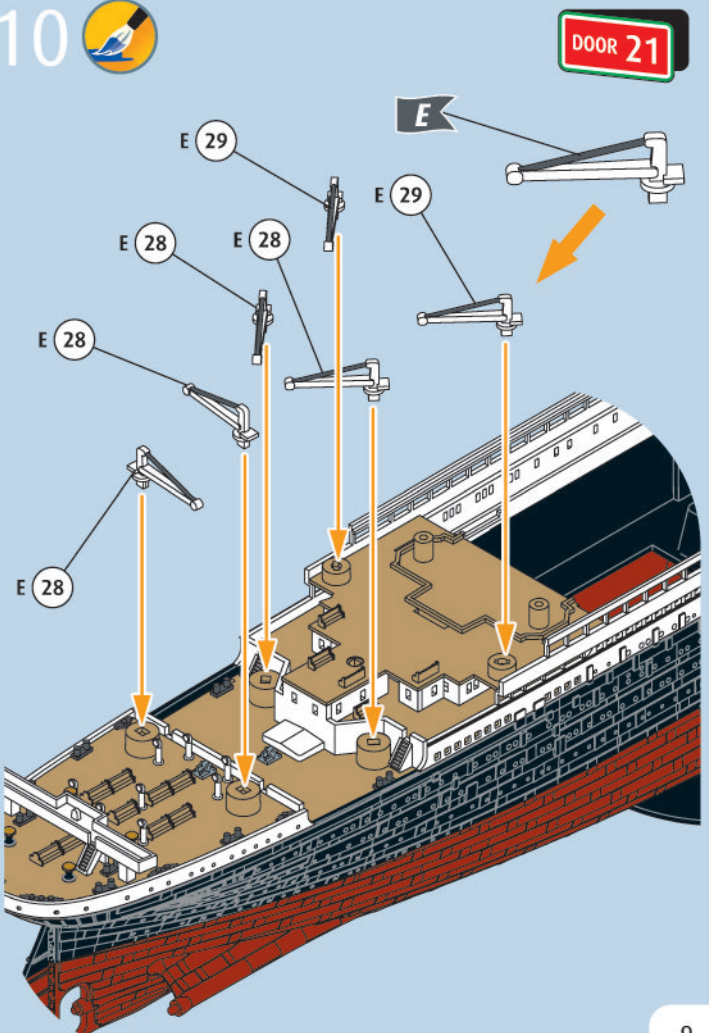

11



DOOR 22

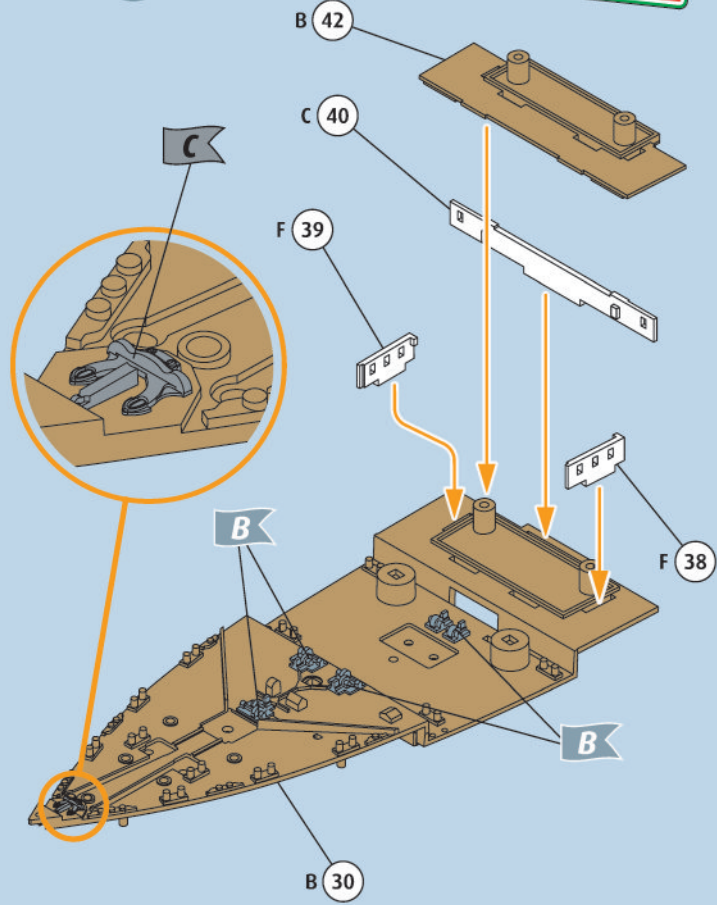

12



DOOR 22

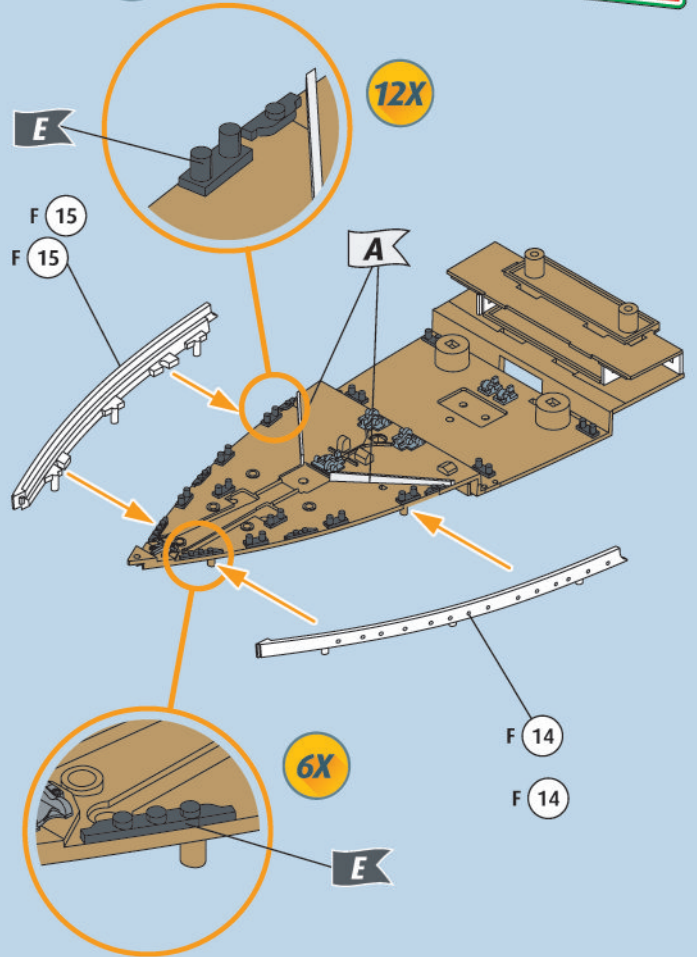

13

DOOR 22

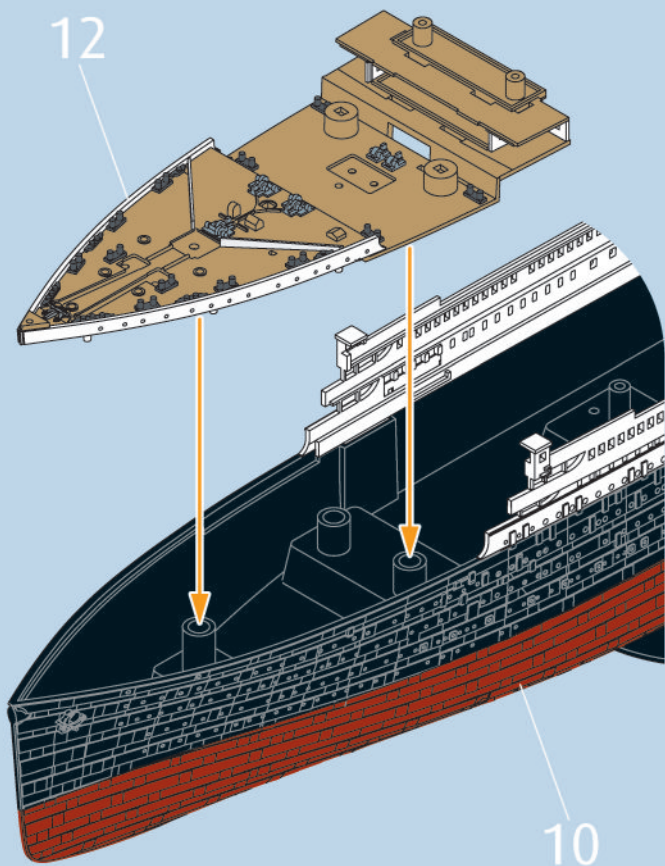

14

DOOR 22

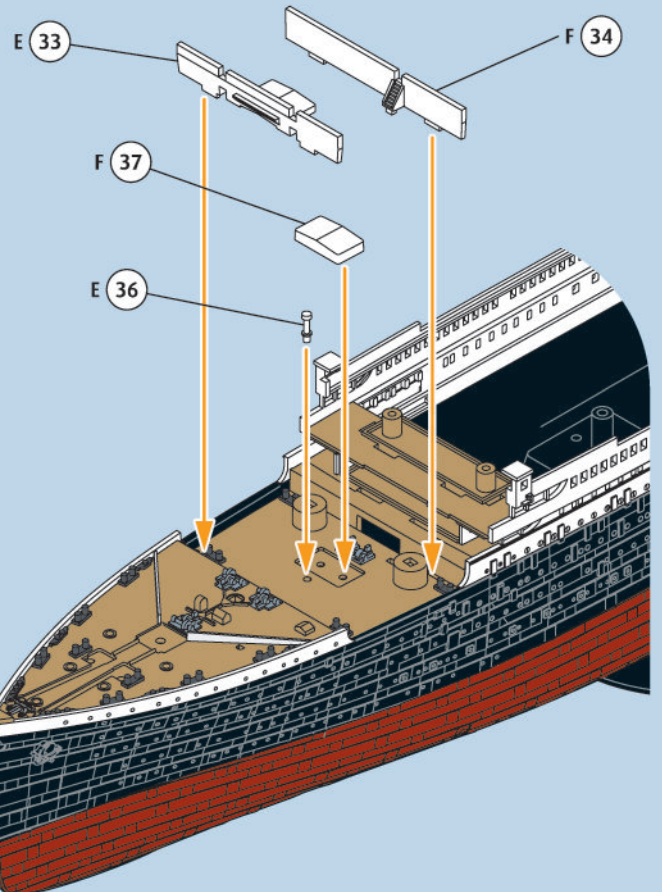

15



DOOR 22

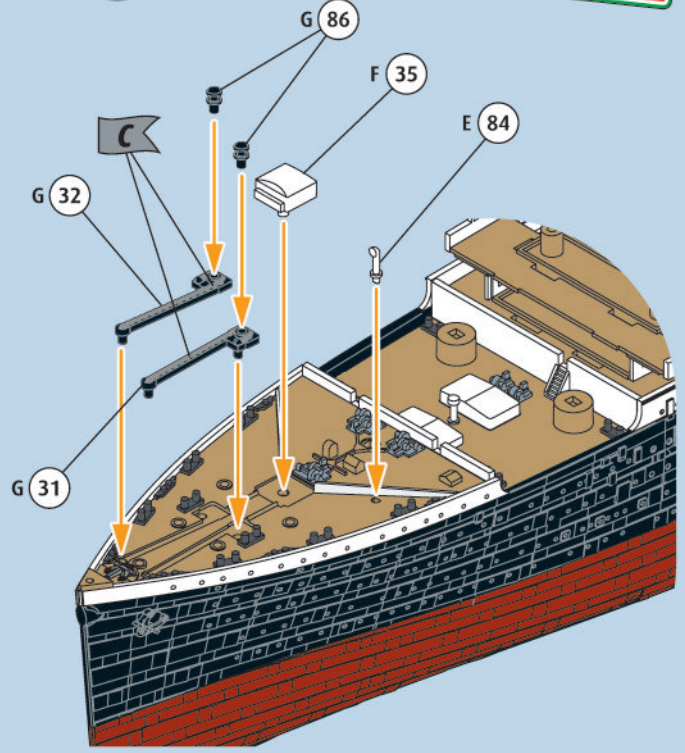

16



DOOR 22

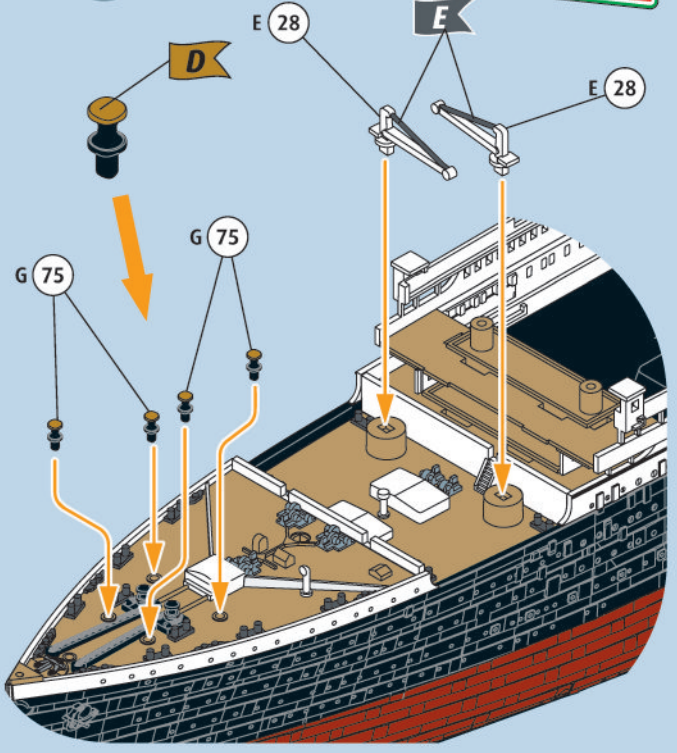

17

DOOR 16

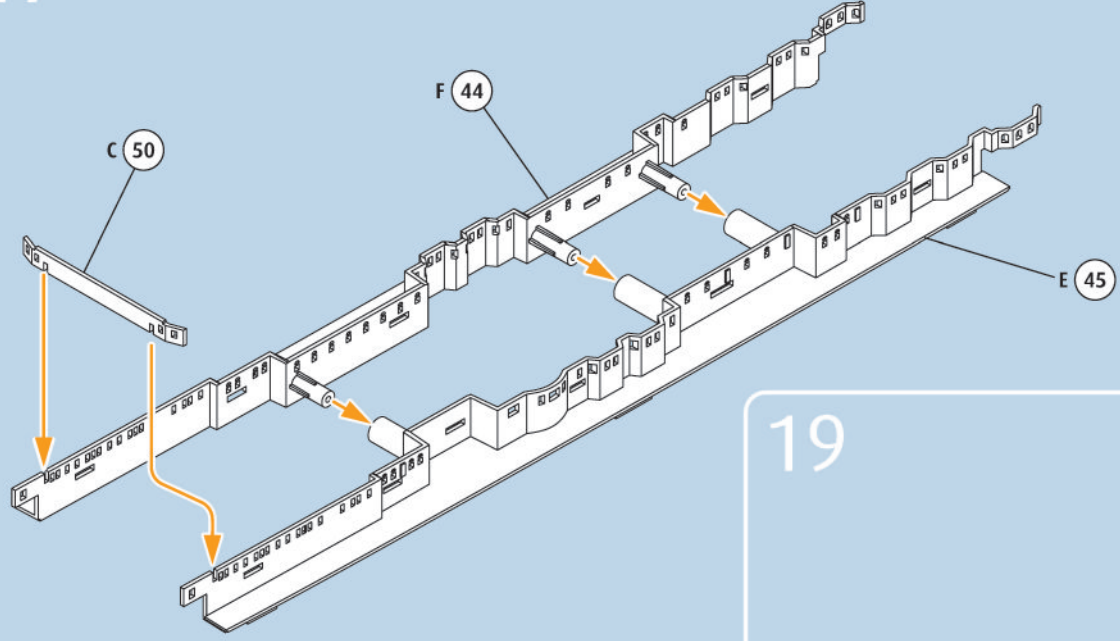

18



DOOR 22

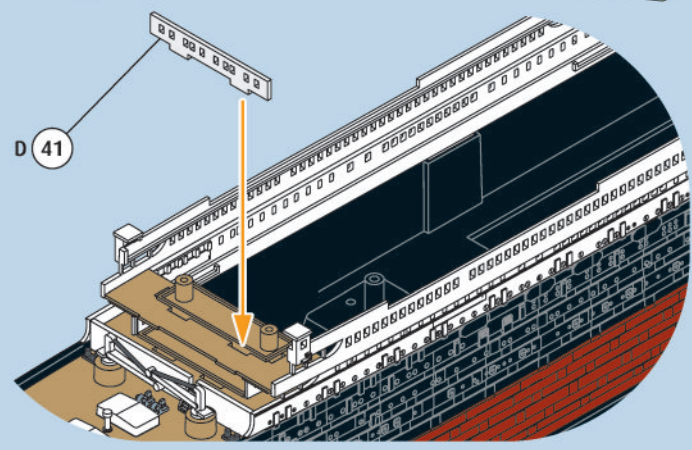

19

DOOR 22

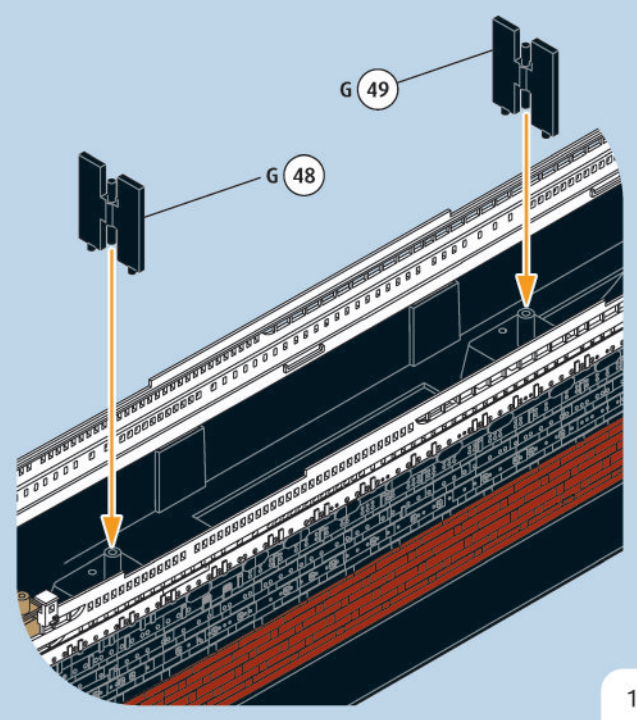

20

DOOR 22

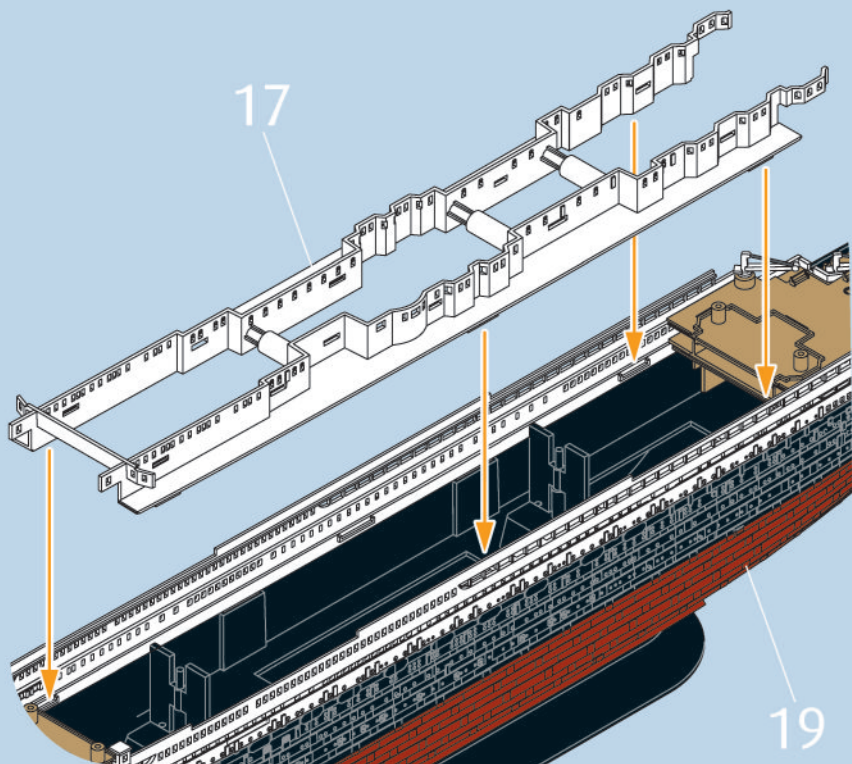

21

DOOR 22

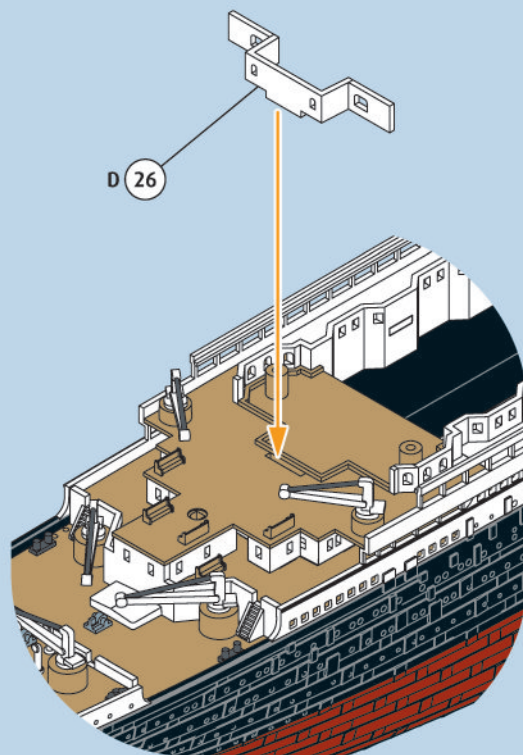

22



DOOR 22

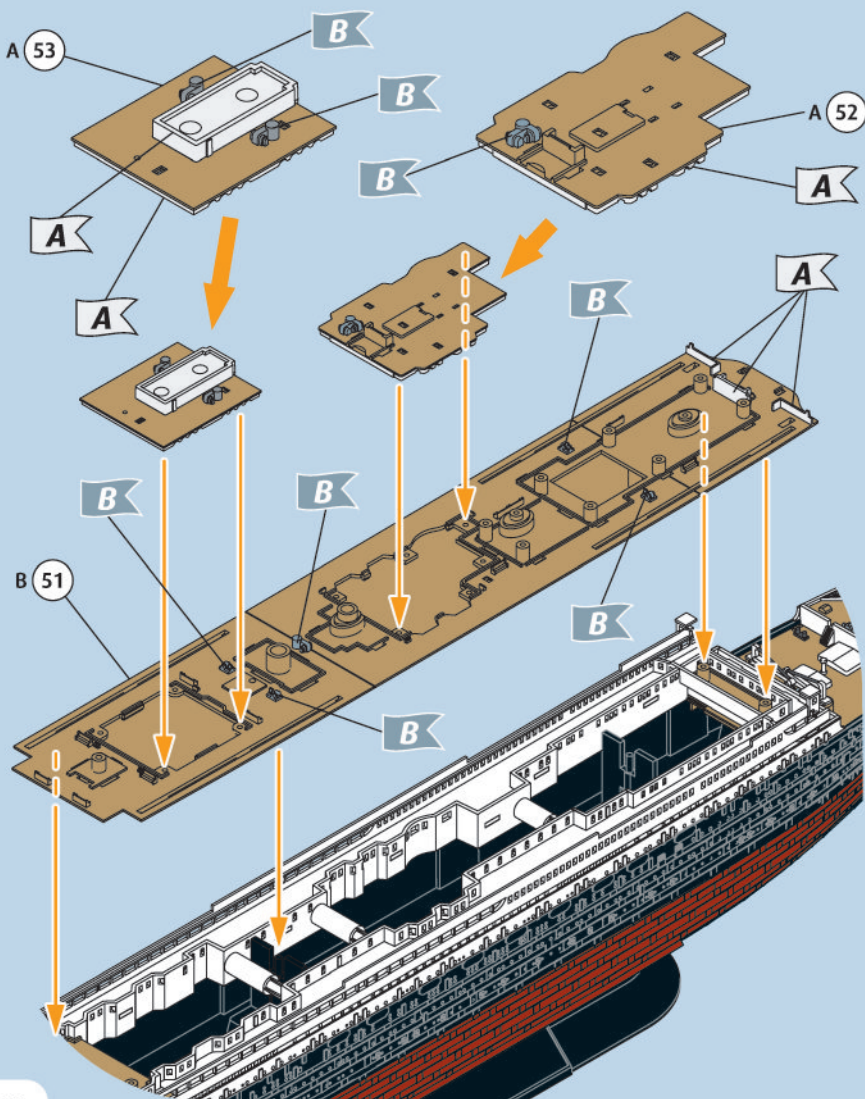

23



DOOR 22

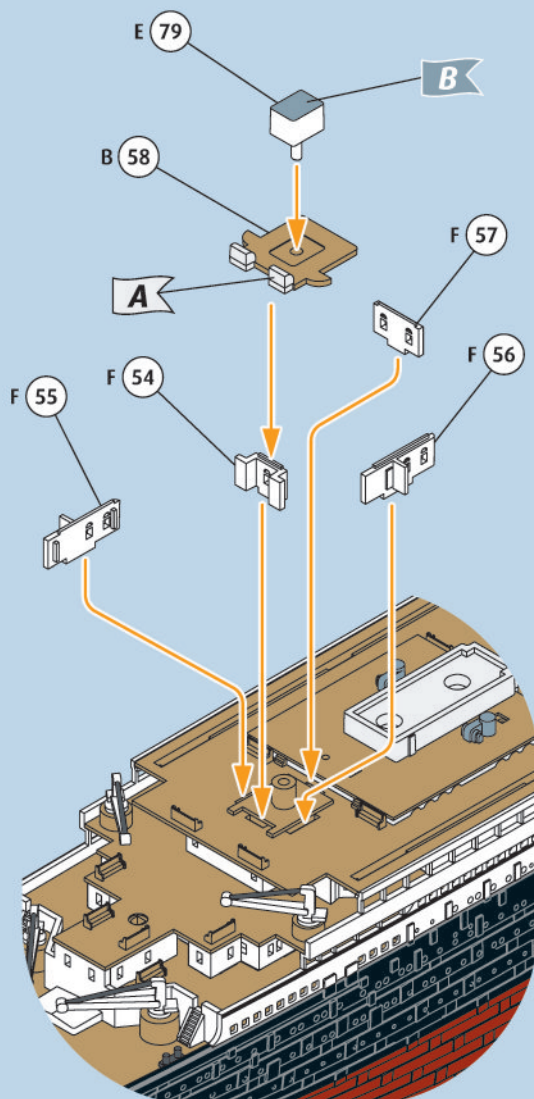

24

DOOR 22

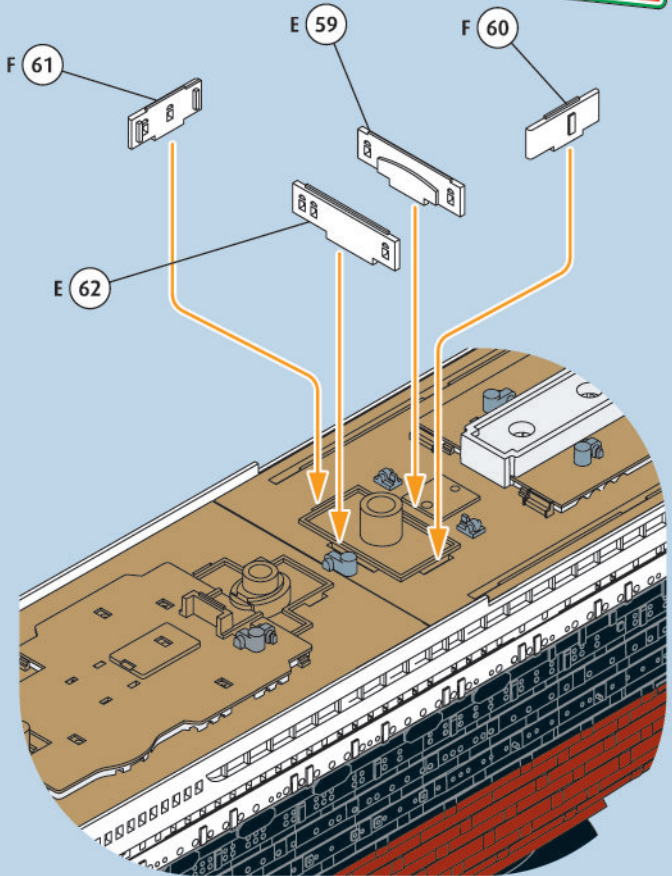

25

DOOR 22

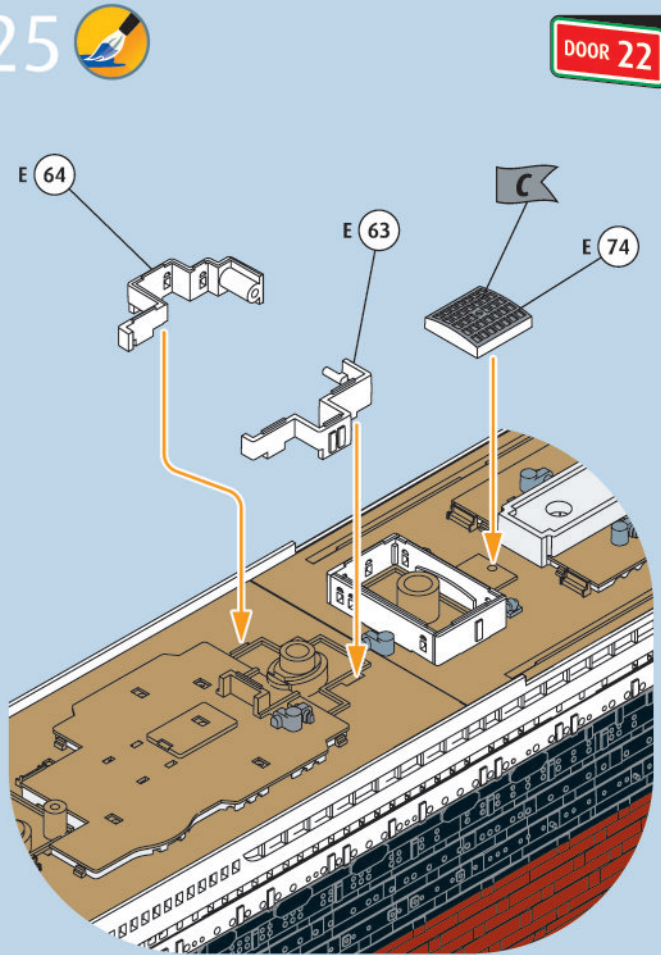

26

DOOR 22

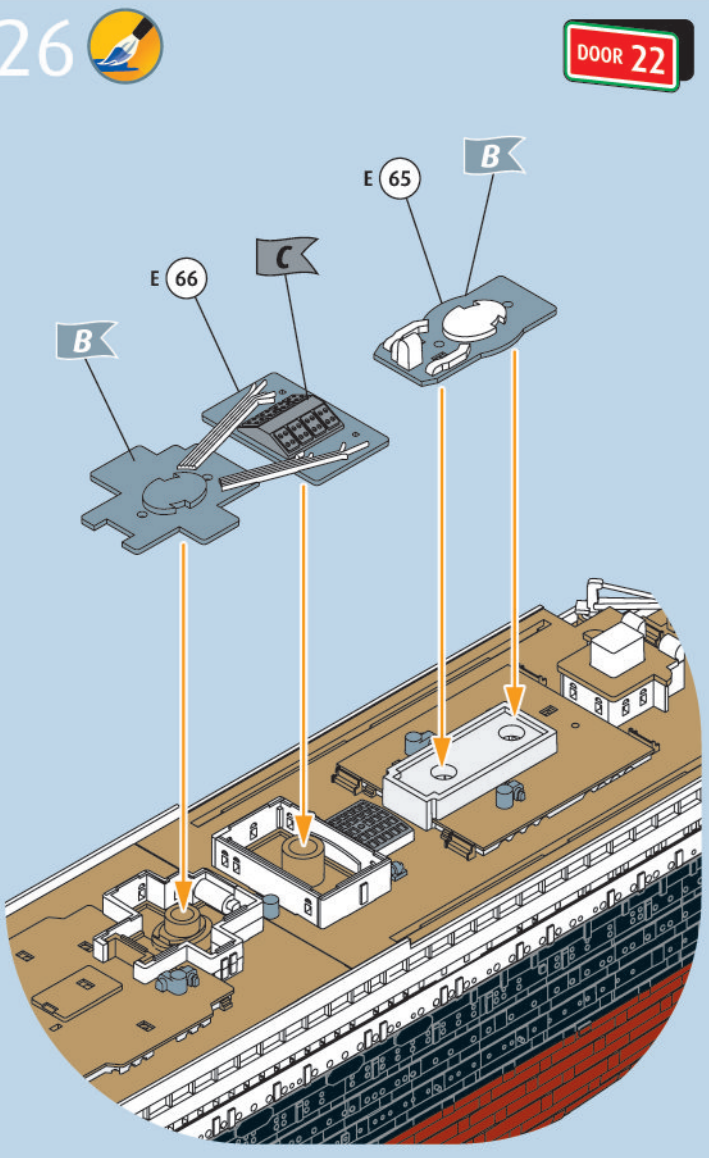

27

DOOR 22

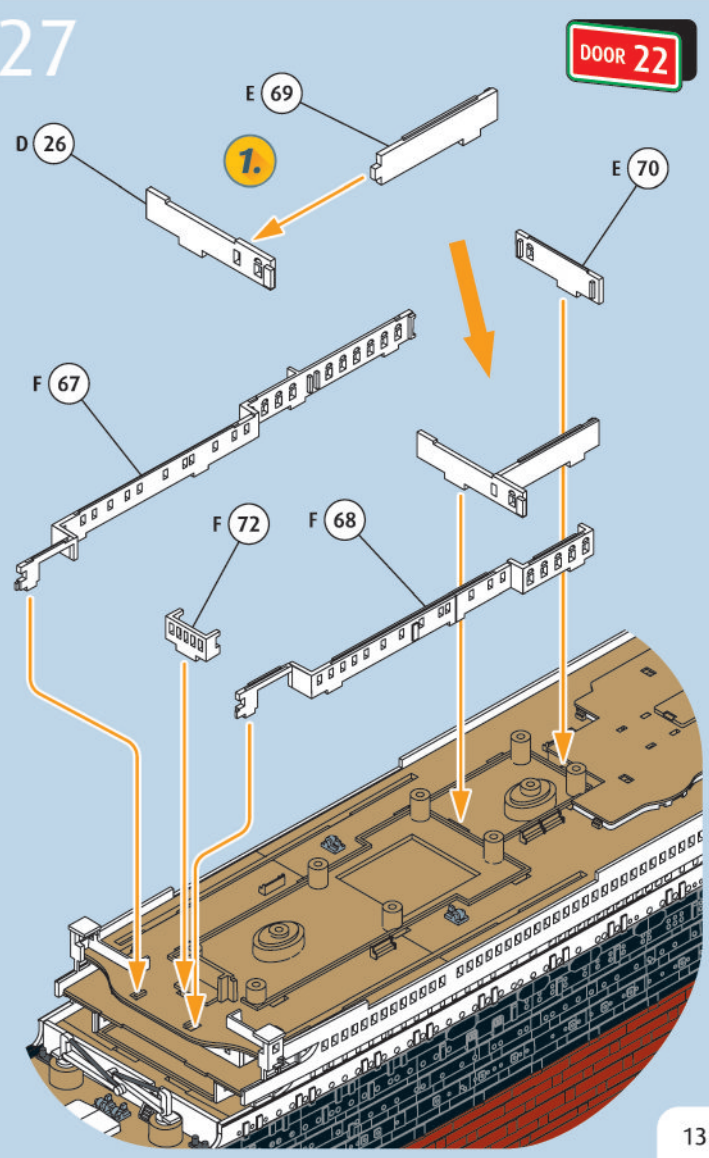

28 

DOOR 22

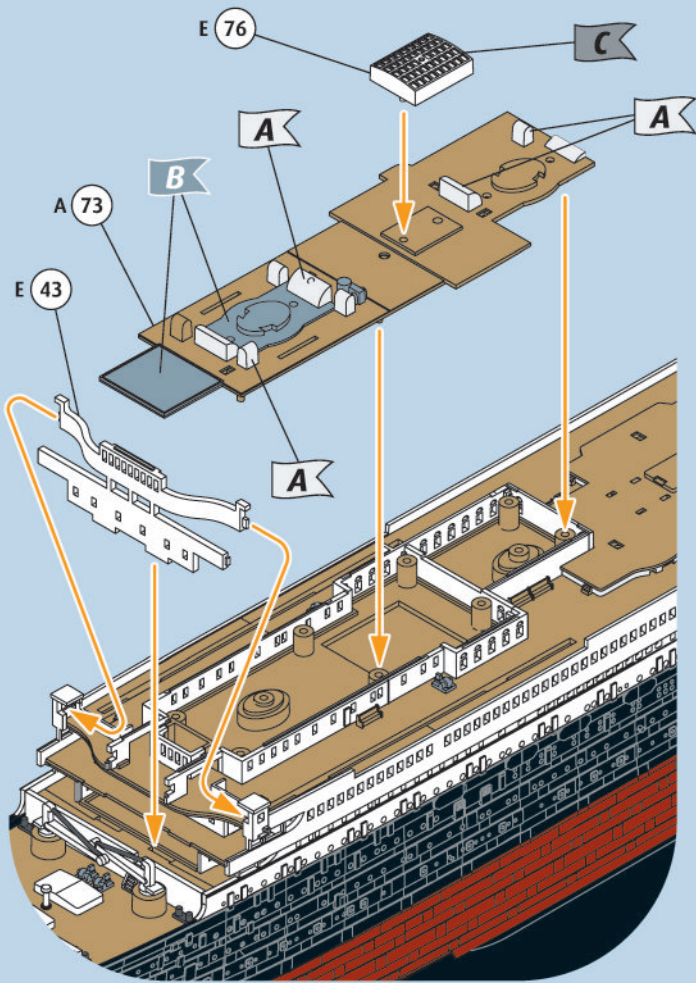

29

DOOR 22

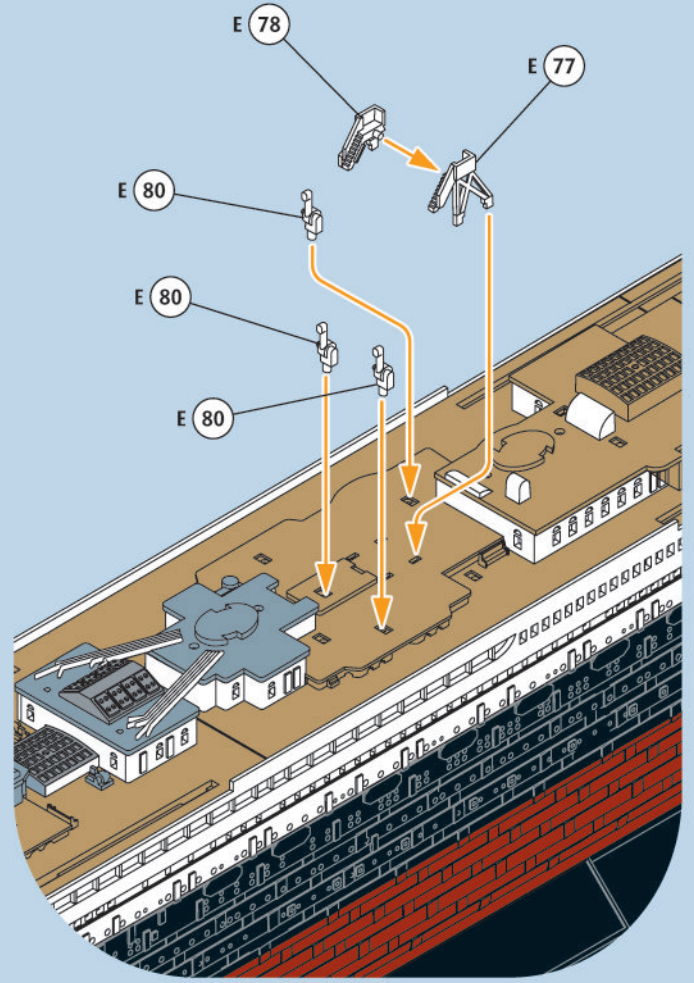

30

DOOR 22

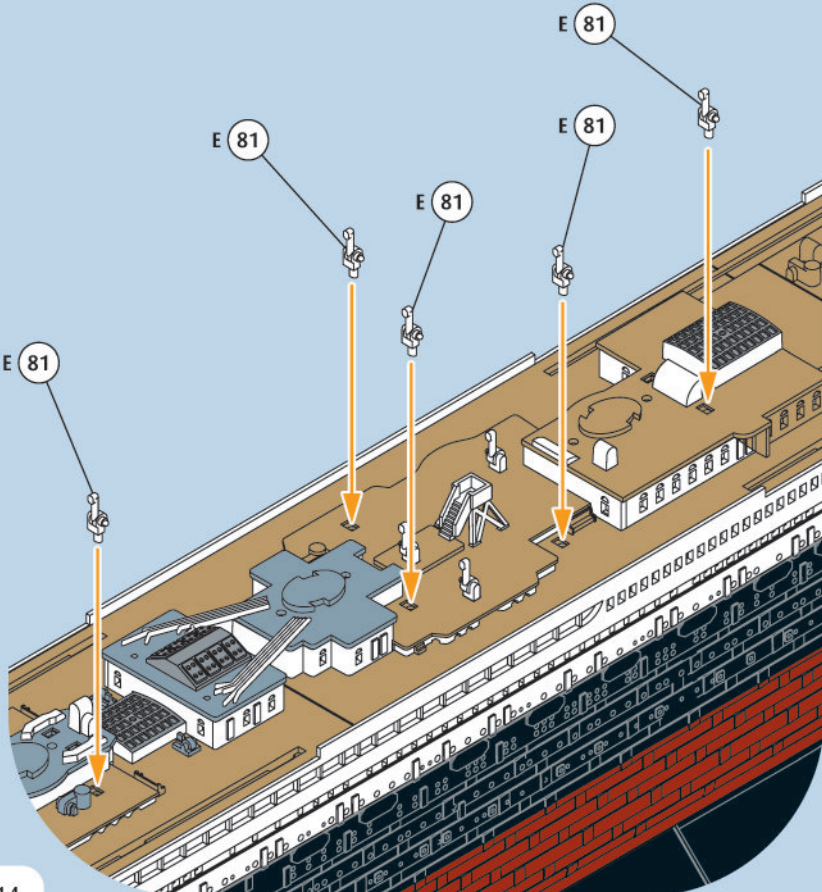

31

DOOR 22

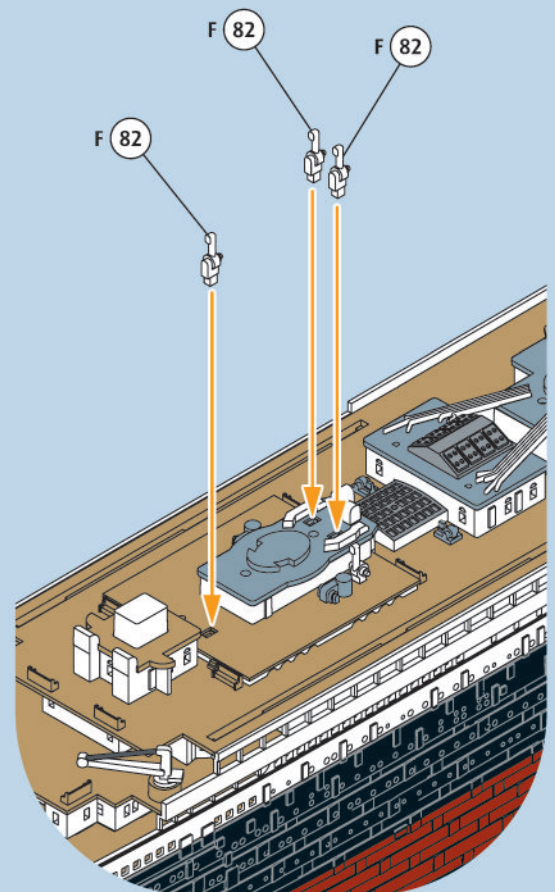

32

DOOR 22

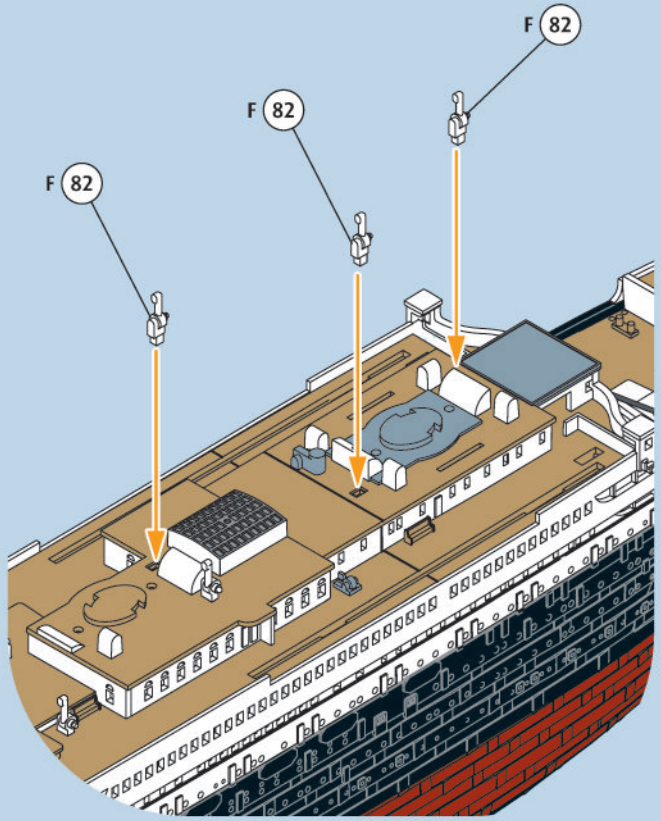

33

DOOR 22

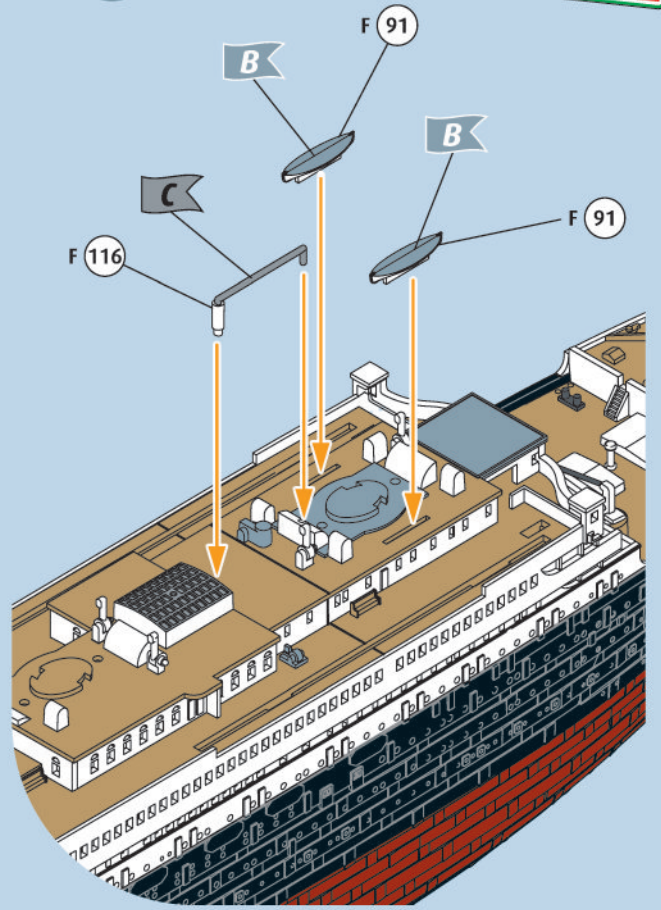

34

DOOR 22

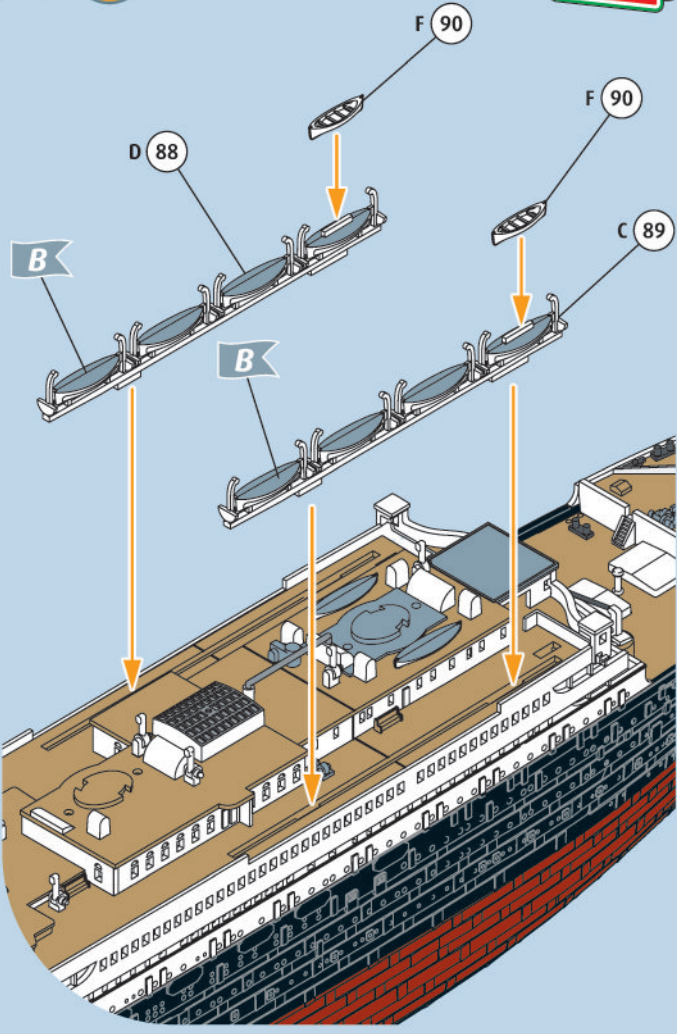

35

DOOR 22

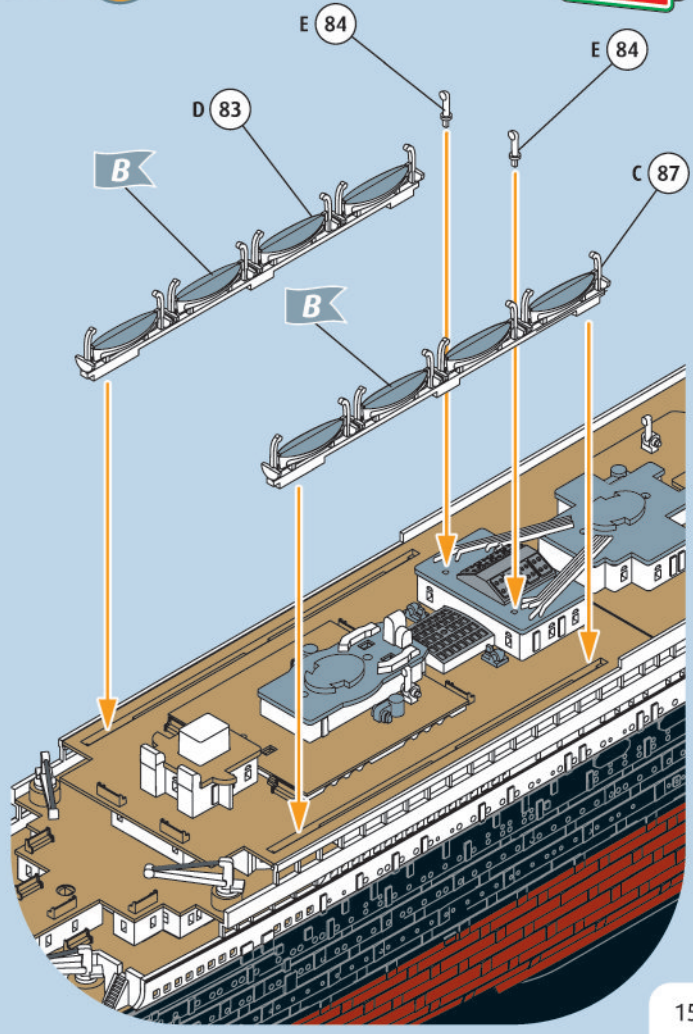

36

DOOR 23

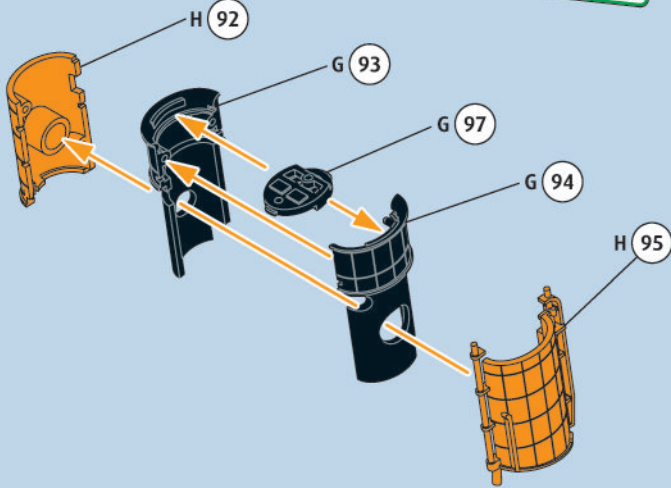

37

DOOR 23

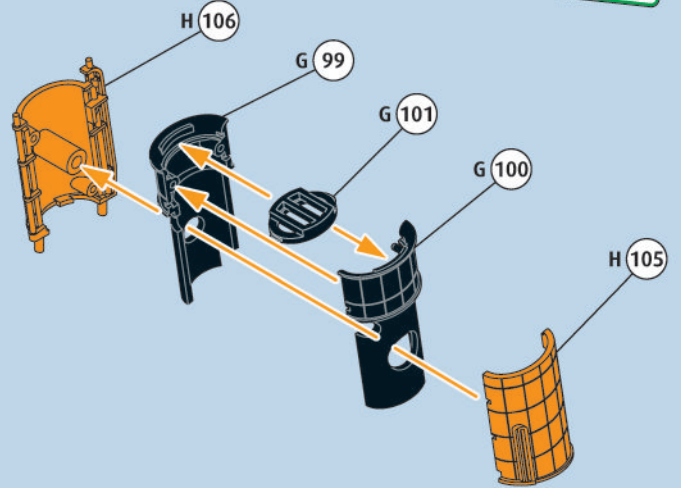

38

DOOR 23

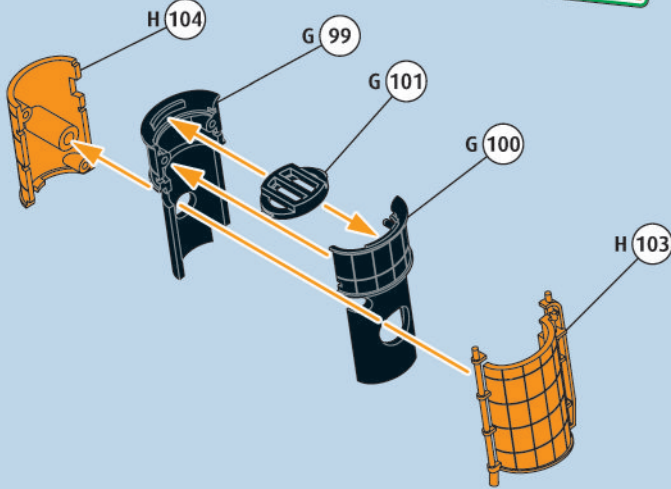

39

DOOR 23

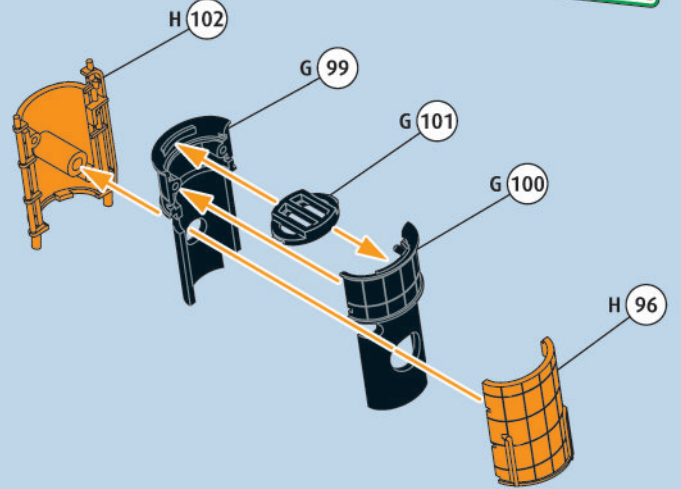

40

DOOR 23

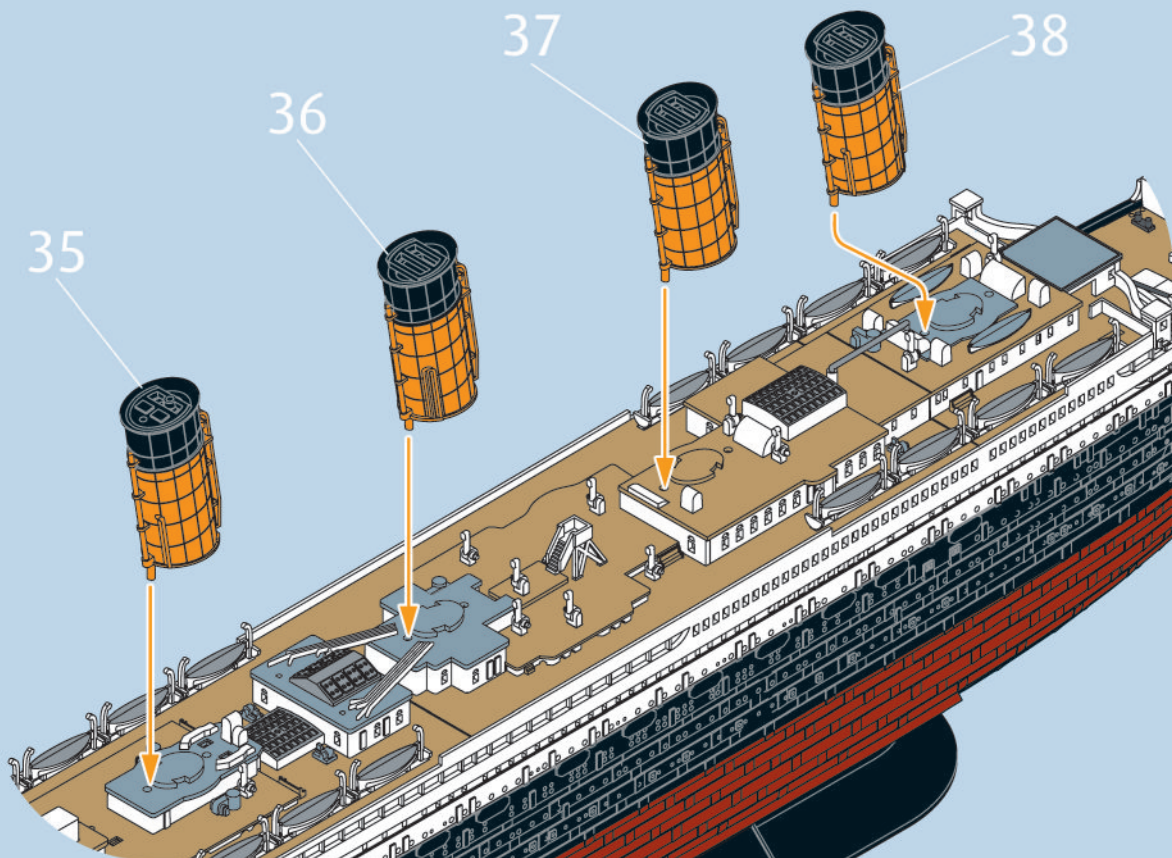

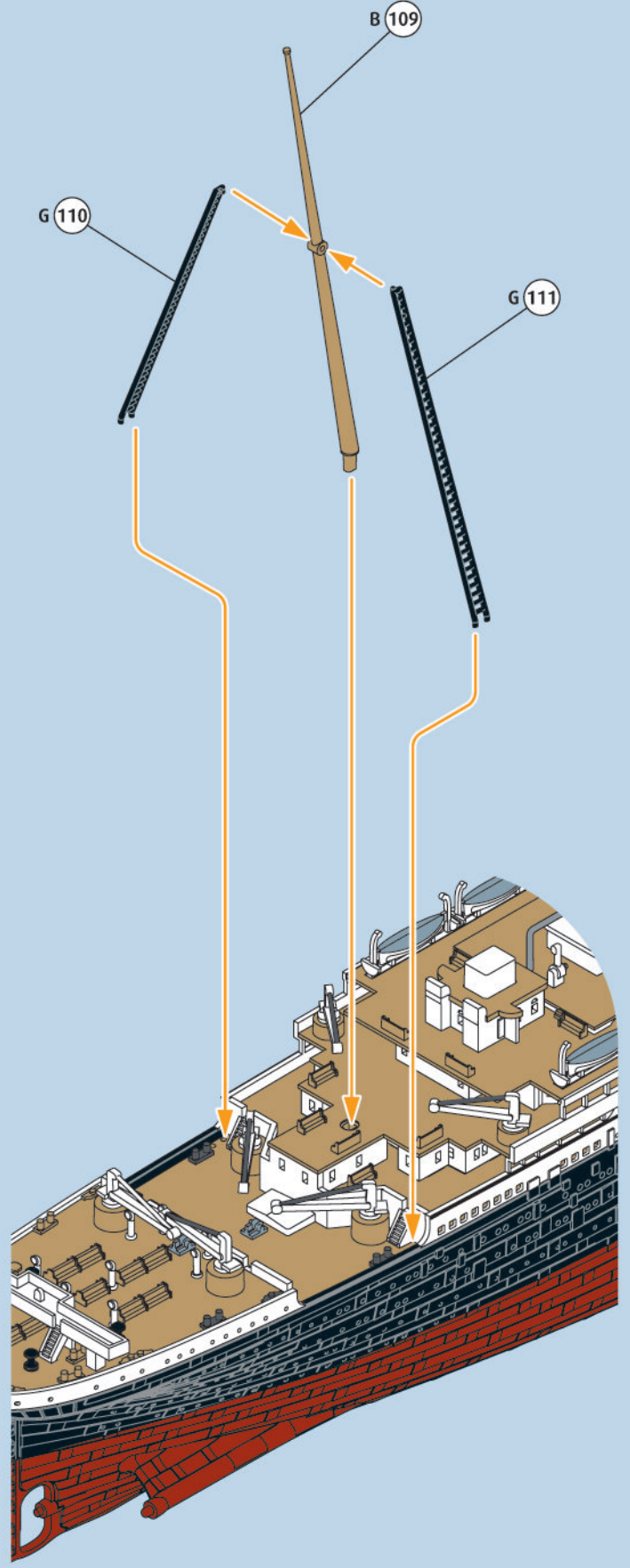
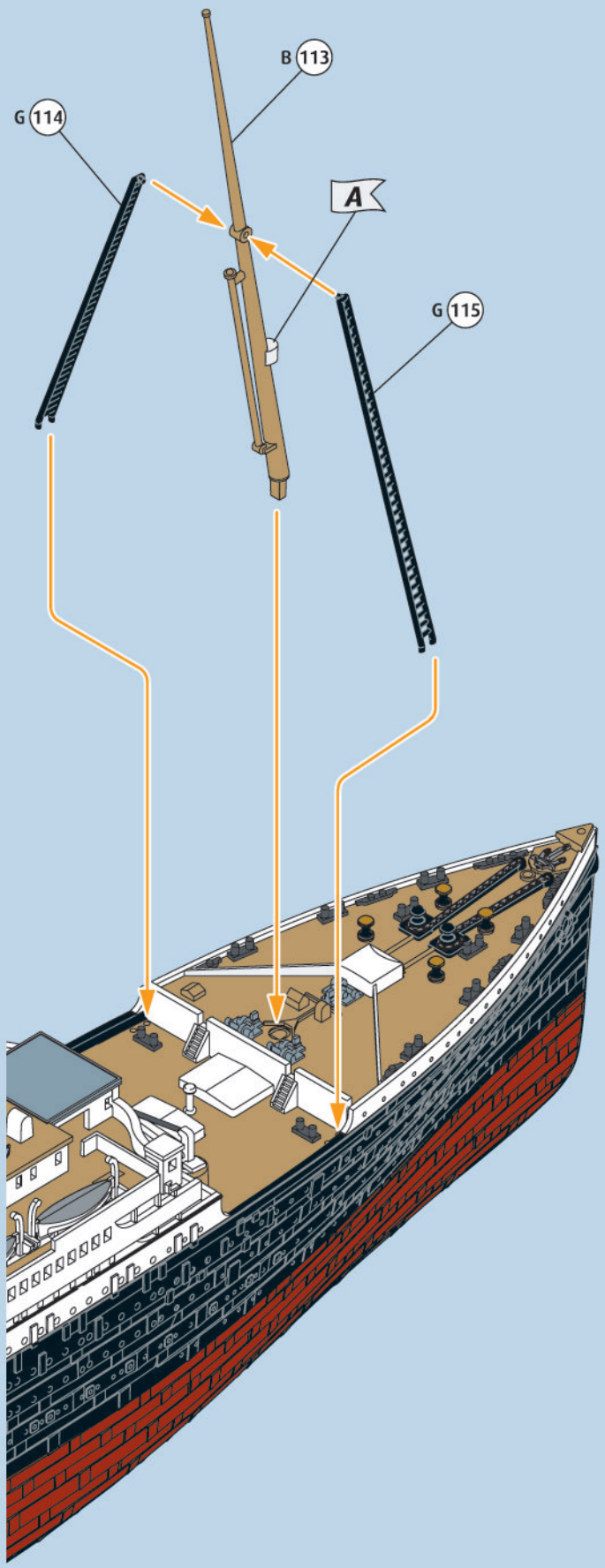

43



DOOR 23

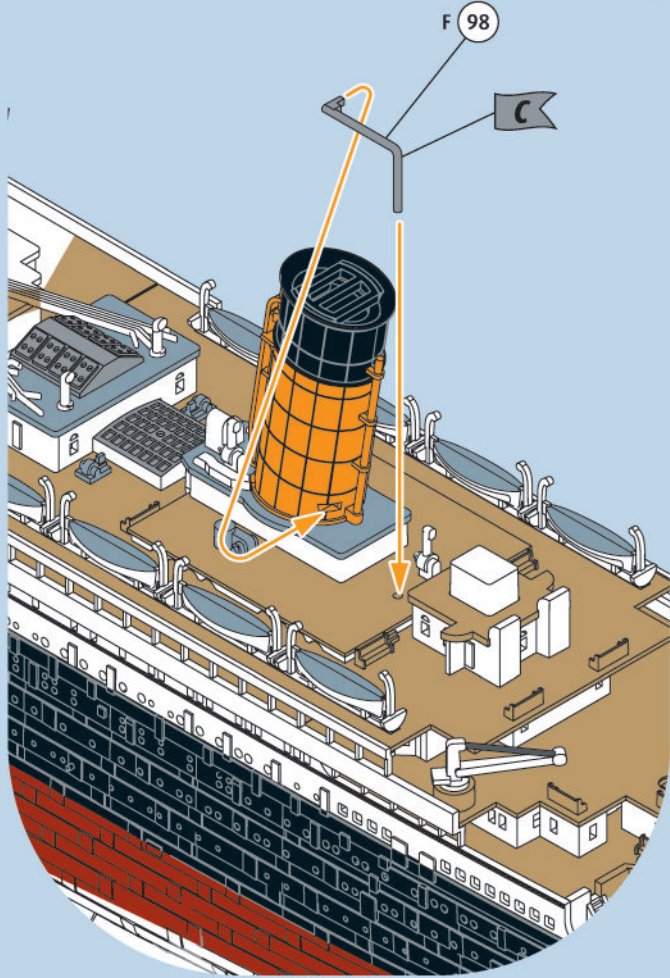

44

DOOR 23

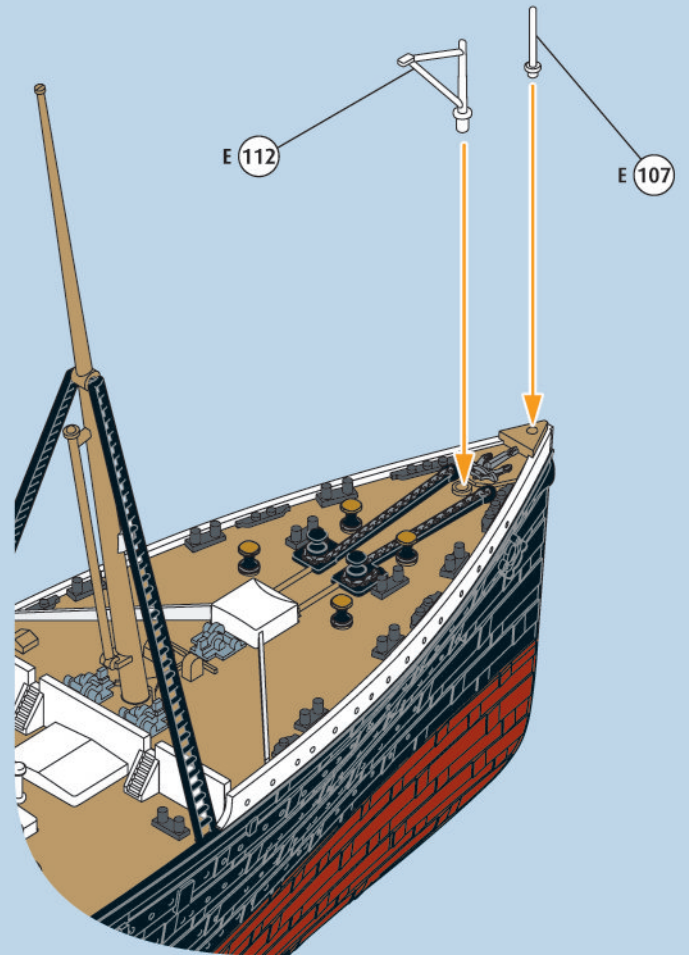

45



DOOR 23

