

Christen Eagle II 90 ARF

Assembly Manual



HANGAR 9®

Notice

All instructions, warranties and other collateral documents are subject to change at the sole discretion of Horizon Hobby, Inc. For up-to-date product literature, visit <http://www.horizonhobby.com> and click on the support tab for this product.

Meaning of Special Language

The following terms are used throughout the product literature to indicate various levels of potential harm when operating this product:

NOTICE: Procedures, which if not properly followed, create a possibility of physical property damage AND a little or no possibility of injury.

CAUTION: Procedures, which if not properly followed, create the probability of physical property damage AND a possibility of serious injury.

WARNING: Procedures, which if not properly followed, create the probability of property damage, collateral damage, and serious injury OR create a high probability of superficial injury.



WARNING: Read the ENTIRE instruction manual to become familiar with the features of the product before operating. Failure to operate the product correctly can result in damage to the product, personal property and cause serious injury.

This is a sophisticated hobby product and NOT a toy. It must be operated with caution and common sense and requires some basic mechanical ability. Failure to operate this Product in a safe and responsible manner could result in injury or damage to the product or other property. This product is not intended for use by children without direct adult supervision. Do not attempt disassembly, use with incompatible components or augment product in any way without the approval of Horizon Hobby, Inc. This manual contains instructions for safety, operation and maintenance. It is essential to read and follow all the instructions and warnings in the manual, prior to assembly, setup or use, in order to operate correctly and avoid damage or serious injury.

Table of Contents

Notice.....	2
Meaning of Special Language.....	2
Introduction.....	2
Product Support.....	2
Specifications.....	2
Included Parts Listing.....	3
Contents of Kit and Parts Listing.....	4
Safety Precautions and Warnings.....	4
Important Information Regarding Warranty.....	5
Using the Manual.....	5
UltraCote Covering Colors.....	5
Recommended Power Setups.....	5
Transmitter Requirements.....	5
Radio Equipment Requirements.....	5
Field Equipment Required.....	6
Optional Field Equipment.....	6
Required Adhesives.....	6
Required Tools.....	6
Before Starting Assembly.....	6
Binding the Radio System.....	6
Landing Gear Installation.....	7
Tail Installation.....	9
Tail Wheel and Control Horn Installation.....	12
Radio Installation.....	13
Aileron Servo Installation.....	15
Cabane Strut Installation.....	17
Electric Power Installation.....	18
4-Stroke Engine Installation.....	20
Fuel Tank Installation.....	21
Throttle Pushrod Installation.....	23
Cowling Installation.....	24
Wing Installation.....	27
Center of Gravity.....	29
Control Throws.....	30
Preflight.....	31
Range Test Your Radio.....	31
Safety Do's and Don'ts for Pilots.....	31
Daily Flight Checks.....	31
Limited Warranty.....	31
Warranty Services.....	32
Compliance Information for the European Union.....	33
Academy of Model Aeronautics National Model Aircraft Safety Code.....	33
Building and Flying Notes.....	34–35

Introduction

Introduced in 1977, the Christen Eagle II was the brainchild of avid aerobatic pilot and entrepreneur, Frank Christensen. His idea? Give pilots a refined, aerobatic kit plane almost anyone could build. The sporty little two-seater was so well-received that a slightly modified, single-seat version became the plane of choice for one of the greatest aerobatic demonstration teams of all time—Charlie Hillard, Tom Poberezny and Gene Soucy, otherwise known as The Eagles. The trio flew the plane from 1979 through 1995, thrilling millions at air shows all over the world.

The Hangar 9 Christen Eagle II 90 ARF brilliantly captures the spirit of this remarkable airplane. Constructed of top quality balsa and light plywood, it will eagerly perform extreme aerobatics just like its full-scale inspiration using your choice of glow or brushless electric power options. And it comes out of the box with a level of scale fidelity that truly sets it apart from the rest of the sport model crowd.

If you're a sport flyer ready for more advanced planes or an aerobatic pro looking for a fun, sport scale model, the Christen Eagle II 90 has what you're after.

Product Support

For technical assistance with this product, please contact the appropriate Horizon Product Support office. This information is located in the back of this manual.

Specifications

Wingspan	54.0 in (137cm)
Fuselage Length	50.8 in (129cm)
Wing Area (total)	878 sq in (56.7 sq dm)
Wing Area (top)	446 sq in
Wing Area (bottom)	432 sq in
Weight Range	8.50 lb–10.0 lb (3.85–4.50 kg)
Engine/Motor Size	.75–.91 2-stroke 1.15–1.25 4-stroke E-Flite® Power 90, 75A ESC, 4S Li-Po (2)
Radio	4+ channel with 5 servos (4 servos for EP)

Included Parts Listing

QUANTITY DESCRIPTION AND USAGE

- 1 Fuselage with hatch, pushrods and landing gear attach bolts
- 1 Fin and rudder with hinges
- 1 Stabilizer with elevator and hinges
- 1 Upper left wing panel
- 1 Upper right wing panel
- 1 Lower left wing panel
- 1 Lower right wing panel
- 2 Wheel pants with axles and hardware
- 1 Landing gear
- 2 Landing gear intersection fairings
- 2 Wing transport frames with rubber bands
- 2 Interplane struts
- 1 Upper wing center rib
- 2 Aluminum cabane struts
- 1 Landing gear cover

SPINNER BAG

- 1 70mm plastic spinner with backplate
- 2 M3 x 5 self-tapping screws
Spinner to backplate

WHEEL BAG

- 2 75mm foam wheels
- 2 M3 x 12 self-tapping screws
Attaches tailwheel to fuselage
- 1 Tailwheel assembly
- 1 Steering bracket
Attaches to rudder to actuate tailwheel
- 4 Wheel collar
Wheel retention

TANK BAG

- 1 Fuel Tank 14.3oz (425cc)
- 1 Assembled stopper
Fuel tank stopper, stopper plates and tubing
- 1 Clunk
- 1 Fuel tubing 550mm

WOODEN PARTS BAG

- 1 Throttle pushrod standoff
Throttle pushrod
- 1 Black-covered balsa block
Fuselage filler behind stabilizer
- 2 20mm x 15mm ply plates with M3 blind nut
Wheel pant retaining plates

PLYWOOD PIECES

- 1 Template
Engine mounting template for Saito 1.25 and Power 90
- 2 Wooden frames
Retaining pieces for fuel tank

ENGINE MOUNT BAG

- 2 Engine mount
2-stroke/4-stroke engine mounting
- 4 M4 x 30 machine screw
Engine mount to firewall
- 4 M4 washers
Engine mount to firewall
- 4 M4 blind nuts
Engine mount to firewall

EP BAG

- 1 Wood battery tray
- 1 300mm triangle stock
- 1 Wood motor standoff box
- 4 M4 blind nuts
Motor box to firewall attachment
- 2 M3 x 15 socket head machine screws
- 2 M3 steel washers
- 4 M4 x 25 socket head machine screws
Motor box to firewall attachment
- 4 M4 steel washers
Motor box to firewall attachment

PUSHROD BAG

- 2 M3 x 270 double threaded rod with nuts
Aileron interconnecting rods
- 1 12mm x 370mm aluminum tube
Upper wing joiner
- 1 12mm x 420mm aluminum tube
Lower wing joiner
- 1 1.5mm x 750mm rod with nylon housing
Throttle pushrod

HARDWARE BAG

- 8 2.6mm x 16mm aluminum pins
Interplane strut alignment pins
- 2 M3 x 70 double threaded rod with M3 nuts
Aileron pushrods
- 8 M3 steel clevis with silicone keepers
Ailerons (4), aileron interconnect (4)
- 4 M3 x 45 machine screws
Interplane strut attachment
- 4 Nylon control horns
Aileron (2), elevator and rudder
- 2 Nylon control horn backplates
Elevator and rudder
- 9 M3 x 10 socket head machine screws
Cabane strut attachment to fuselage (4), cabane strut attachment to center rib (2), Upper wing retention (1), Lower wing retention (2)
- 2 M3 x 10 socket head machine screws
Wheel pant retention
- 4 M3 x 8 self-tapping screws
Cowl mounting
- 4 M4 x 30 machine screws
Engine to engine mount
- 8 M4 steel washers
Engine to engine mount
- 10 M3 steel washers
Cabane strut attachment to fuselage (4), Upper wing retention (1), Lower wing retention (2), Wheel pant retention (2)
- 4 M4 nylon lock nuts
Engine to engine mount
- 1 Pushrod connector
Throttle pushrod connection at servo
- 6 M2 x 12 machine screws
Rudder and elevator control horns
- 6 M2 x 12 self-tapping screws
Aileron control horns
- 2 M3 nuts
Cabane strut attachment to center rib

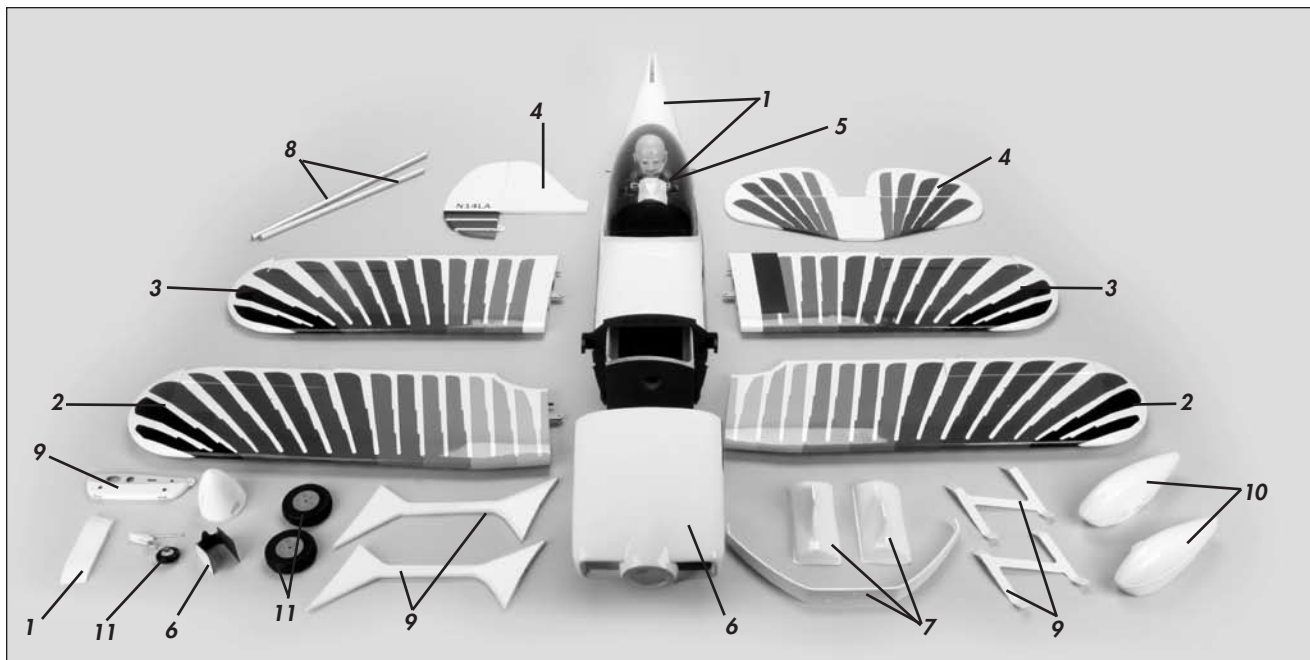

Contents of Kit and Parts Listing

Replacement Parts

1. HAN501001	Fuselage with Hatch
2. HAN501002	Upper Wing Set
3. HAN501003	Lower Wing Set
4. HAN501004	Tail Set
5. HAN501005	Canopy Hatch
6. HAN501006	Fiberglass Cowling
7. HAN501008	Landing Gear with Fairings
8. HAN501009	Wing Tube Set
9. HAN501010	Wing Strut Set
10. HAN501013	Fiberglass Wheel Pants
11. HAN501014	Wheels and Tailwheel Assembly

Items Not Shown

HAN501007	Wing Transport Frames
HAN501011	Hardware Pack
HAN501012	Pushrod Set
HAN501015	Engine Mount Set with Spinner
HAN501016	Electric Power Mounting Set

Safety Precautions and Warnings

Read and follow all instructions and safety precautions before use. Improper use can result in fire, serious injury and damage to property.

Age Recommendation: Not for children under 14 years. This is not a toy.

COMPONENTS

Use only with compatible components. Should any compatibility questions exist, please refer to the product instructions, the component instructions or contact Horizon Hobby, Inc.

FLIGHT

Fly only in open areas to ensure safety. It is recommended flying be done at AMA (Academy of Model Aeronautics) approved flying sites. Consult local ordinances before choosing a flying location.

PROPELLER

Keep loose items that can get entangled in the propeller away from the prop, including loose clothing or other objects such as pencils and screwdrivers. Especially keep your hands away from the propeller as injury can occur.

BATTERIES

Notes on Lithium Polymer Batteries

When used improperly, lithium polymer batteries are significantly more volatile than alkaline or Ni-Cd/Ni-MH batteries used in RC applications. Always follow the manufacturer's instructions when using and disposing of any batteries. Mishandling of Li-Po batteries can result in fire causing serious injury and damage.

SMALL PARTS

This kit includes small parts and should not be left unattended near children as choking and serious injury could result.

Safe Operating Recommendations

- Inspect your model before every flight to ensure it is airworthy.
- Be aware of any other radio frequency user who may present an interference problem.
- Always be courteous and respectful of other users in your selected flight area.
- Choose an area clear of obstacles and large enough to safely accommodate your flying activity.
- Make sure this area is clear of friends and spectators prior to launching your aircraft.
- Be aware of other activities in the vicinity of your flight path that could cause potential conflict.
- Carefully plan your flight path prior to launch.
- Abide by any and all established AMA National Model Aircraft Safety Code.

Important Information Regarding Warranty

Please read our Warranty and Liability Limitations in the back of this manual before building this product. If you as the purchaser or user are not prepared to accept the liability associated with the use of this Product, you are advised to return this Product immediately in new and unused condition to the place of purchase.

Using the Manual

This manual is divided into sections to help make assembly easier to understand and to provide breaks between each major section. In addition, check boxes have been placed next to each step to keep track of each step completed. Steps with a single box (□) are performed once, while steps with two or more boxes (□□) indicate the step will require repeating, such as for a right or left wing panel, two servos, etc. Remember to take your time and follow the directions.

UltraCote® Covering Colors

White	HANU870
Deep Blue	HANU873
Orange	HANU877
Black	HANU874
Smoke Purple	HANU868
Deep Red	HANU871
Flame Red	HANU883
Dark Yellow	HANU889
Bright Yellow	HANU872

Recommended Power Setups

4-STROKE GLOW

Saito™ 125 with Muffler	SAIE125A or SAIE125AK
Muffler Right Angle Manifold	SAI125A163
Evolution 16 x 6 propeller	EVO16060

Optional

Hangar 9® 2 ³ / ₄ -inch aluminum spinner	HAN99003
8 x 1.25mm Prop Adapter Kit	HAN99052
Fuel Filler with T-fitting and Overflow	HAN116
Exhaust Deflector: .35 to .90 Engines	DUB697
Remote Glow Plug Adapter	HAN3025

ELECTRIC

Power 90 Outrunner Motor, 325Kv	EFLM4090A
Phoenix ICE 75 Brushless ESC	CSEPHXICE75
APC 17 x 8 propeller	APC17080E
4000mAh 4S 14.8V 30C (2)	EFLB40004S30
9-inch (228mm) Servo Extension	JRPA096
EC3™ Battery Series Harness, 13AWG	EFLAEC308

Optional

Hangar 9 2 ³ / ₄ -inch aluminum spinner	HAN99003
10mm x 1.5mm Outrunner Adapter	TRUE08394A

Transmitter Requirements

This model requires a minimum of a 4-channel radio to operate all the functions of your aircraft. We suggest the following radio systems available through Horizon Hobby or your local hobby distributor.

Spektrum DX6i	SPM6610
Spektrum DX8	SPM8800
JR® DSM2™ or DSMX® Systems	

Radio Equipment Requirements

The following items are recommended when installing the 8-Channel AR8000 (SPMAR8000).

AR8000 8-Channel DSMX Receiver	SPMAR8000
JR Chargeswitch	JRPA004
2700mAh Receiver Battery, 6V	JRPB5008
A6060 Standard Digital Aircraft Servo (5)	SPMSA6060
3-inch (76mm) Servo Extension (4)	SPMA3050

Servo Placement and Extensions:

Aileron:	A6060 Standard Digital Servo (2) 3-inch (76mm) (2) receiver to 3-inch (76mm) (2) aileron servo
Rudder:	A6060 Standard Digital Servo
Elevator:	A6060 Standard Digital Servo
Throttle:	A6060 Standard Digital Servo (not required for EP installations)

Optional Equipment

Telemetry for the DX8	SPM9548
-----------------------	---------

Field Equipment Required

Fuel (15% recommended)	
Saito Glow Plug	SAIP400S
Long Reach Glow Plug Wrench	HAN2510
Metered Glow Driver XL with Charger	HAN7115
2-Cycle Sport Plug	EVOGP1
Ultra Fuel Pump (gas and glow)	HAN155
Evolution Oil	EVOX1001Q

Optional Field Equipment

PowerPro™ 12V Starter	HAN161
12V 7Ah Sealed Battery	HAN102
Power Panel	HAN106
Blue Block After Run Oil	EVOX1001
Self-stick weights, 6 oz	HAN3626
Charger	EFL3025
Spray cleaner	
Paper towels	

Required Adhesives

<input type="checkbox"/> 30-minute Epoxy	PAAPT39
<input type="checkbox"/> Thin CA	PAAPT08
<input type="checkbox"/> Medium CA	PAAPT02
<input type="checkbox"/> Canopy Glue	PAAPT56
<input type="checkbox"/> Silicone adhesive	DEVS250
<input type="checkbox"/> Threadlock	PAAPT42

Hardware/Accessory Sizes

Main wheel diameter	2 ⁷ / ₈ in (73mm)
Tail wheel diameter	1 ¹ / ₄ in (32mm)
Spinner diameter	2 ³ / ₄ in (70mm)
Fuel tank size	14 oz (425cc)
Wing tube size	
Upper: 12mm x 371mm	
Lower: 12mm x 425mm	

Required Tools

- Card stock
- Covering iron
- Dental floss
- Dish washing detergent
- Drill bit: 5/64-inch (2mm), 1/8-inch (3mm), 9/64-inch (3.5mm), 11/64-inch (4.5mm), 7/32-inch (5.5mm), 5/16 inch (8mm)
- Epoxy brushes
- Felt-tipped pen
- Flat file
- Hex wrench: 1.5mm, 2.5mm, 3mm, 5/32-inch
- Hobby knife with #11 blade
- Hobby scissors
- Hook and loop tape
- Isopropyl alcohol
- Light machine oil
- Low-tack tape
- Medium grit sandpaper
- Mixing cups
- Mixing sticks
- Needle nose pliers
- Nut driver: 4mm, 7mm
- Open-end wrench: 10mm, 12mm, 1/2-inch
- Paper towels
- Pencil
- Phillips screwdriver: #1, #2
- Pin vise
- Propeller reamer
- Rotary tool
- Ruler
- Sanding drum
- Scissors
- Side cutters
- Spray bottle
- Square
- Straight edge
- Tie wraps
- Toothpicks
- T-pins
- Two-sided tape

Before Starting Assembly

Before beginning the assembly of your model, remove each part from its bag for inspection. Closely inspect the fuselage, wing panels, rudder and stabilizer for damage. If you find any damaged or missing parts, contact the place of purchase.

If you find any wrinkles in the covering, use a heat gun (HAN100) and covering glove (HAN150) or covering iron (HAN101) with a sealing iron sock (HAN141) to remove them. Use caution while working around areas where the colors overlap to prevent separating the colors.

Binding the Radio System

Before starting the assembly of your model, we recommend preparing your radio system for installation. This includes charging the transmitter and receiver batteries, as well as centering the trims and sticks on your transmitter. If using a computer radio, make sure to reset a model memory and name it for this particular model. We also recommend binding the transmitter and receiver at this time, following the instructions provided with your radio system.

➔ *We highly recommend re-binding the radio system once all the control throws are set. This will keep the servos from moving to their endpoints until the transmitter and receiver connect.*

Landing Gear Installation

Required Parts

Fuselage	Landing gear
M3 washer (2)	Wheel pant (right and left)
Landing gear cover	75mm foam wheel (2)
20mm x 15mm plywood plate with M3 blind nut (2)	
5/16-inch metal washer (2)	
5/16-inch plywood washer (2)	
5/32-inch wheel collar with setscrew (4)	
5/32 x 1 1/2-inch axle (2) with nut (2)	
M3 x 10 socket head machine screw (2)	
Landing gear intersection fairing (right and left)	

1. Locate the items for this section of the manual.



2. Temporarily remove the three M4 x 20 socket head screws from the fuselage. Use the M4 x 20 socket head screws and a 3mm hex wrench to secure the landing gear to the fuselage. Use threadlock on the screws to prevent them from vibrating loose.



3. Use medium CA to glue the landing gear cover in place on the bottom of the fuselage.



4. Use hobby scissors to trim the landing gear intersection fairings. Open the narrow end to allow the fairing to fit over the landing gear. Trim as necessary so the fairing fits the contour of the fuselage. Use silicone adhesive to glue the fairings to the fuselage. Use low-tack tape to hold the fairing in position until the adhesive fully cures.

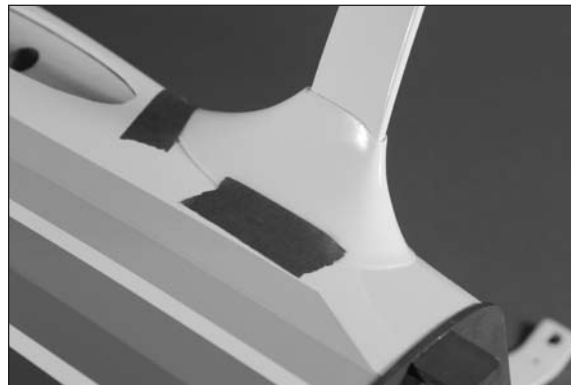
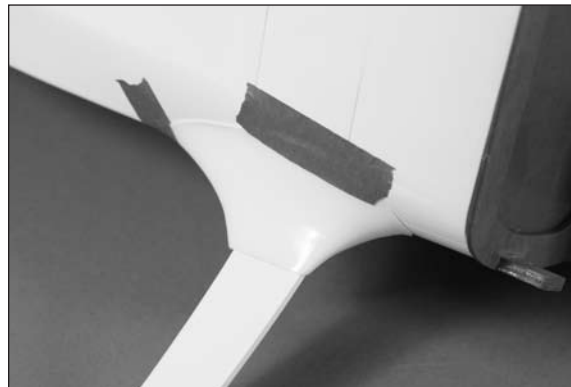

5. Position the wheel pant on the landing gear. The recess of the wheel pant will fit snugly to the shape of the landing gear. Use a felt-tipped pen to mark the location for both the axle and wheel pant retaining bolt.

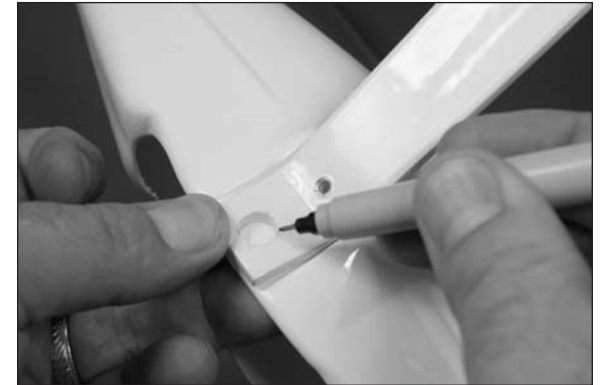

6. Use a drill and 5/16-inch (8mm) drill bit to drill the hole for the axle, and a 1/8-inch (3mm) drill bit for the wheel pant mounting screw.

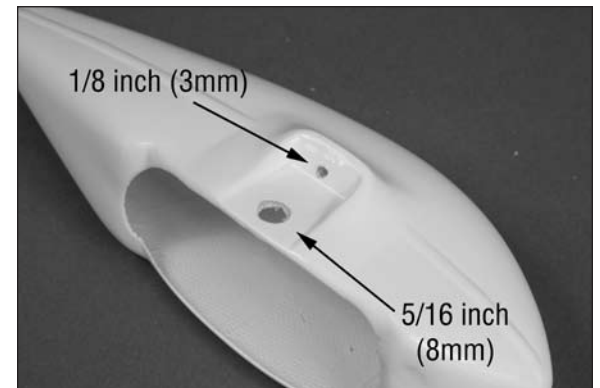

□□ 7. Fit the 20mm x 15mm plywood plate to the wheel pant so the blind nut aligns with the mounting hole in the wheel pant. Use medium grit sandpaper to sand the plate as necessary so the blind nut aligns with the hole in the pant. Use a small amount of 5-minute epoxy to glue the plate inside the wheel pant, being careful not to get glue in the blind nut.

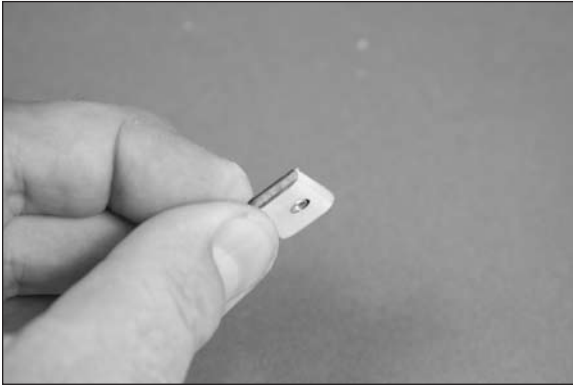

□□ 8. Remove the hardware from the axle. Use a flat file to make a 1/4-inch (6mm) wide flat on the axle that is centered 1 inch (25mm) from the hex on the axle.

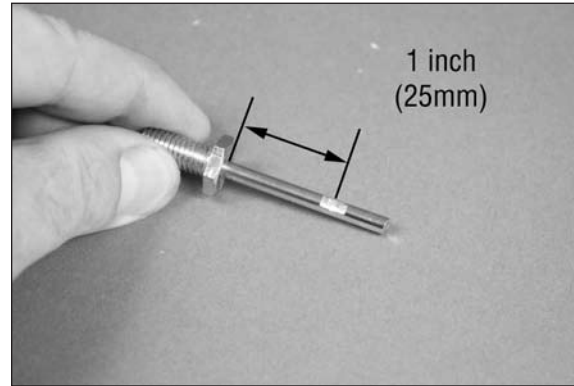

□□ 9. Place a drop of light machine oil on the axle. Secure the wheel to the axle using the wheel collars remove earlier. Tighten the setscrews using a 1.5mm hex wrench. Make sure to use threadlock on the setscrews to prevent them from vibrating loose.

□□ 10. Place the 5/16-inch metal washer, then the 5/16-inch plywood washer on the threaded portion of the axle. Fit the assembly into the wheel pant. You may need to flex the wheel pant open slightly to fit the axle in.



□□ 11. Position the wheel pant on the landing gear. Use an M3 x 10 socket head screw and M3 washer to secure the wheel pant to the landing gear. Use two 1/2-inch open-end wrenches to secure the axle to the landing gear. Make sure to position the setscrews in the wheel collars so they can be checked periodically.



□□ 12. Repeat steps 5 through 11 to install the remaining wheel and wheel pant.

Tail Installation

Required Parts

Fuselage	Stabilizer with elevators
Rudder with fin	Black-covered balsa block
Bottom wing (right and left)	
12mm x 420mm aluminum tube	

□ 1. Locate the stabilizer and elevators. Separate the elevators from the stabilizer. Remove the joiner wire and use medium grit sandpaper to roughen the wire where it contacts the elevators.



□ 2. Mix a small amount of 5-minute epoxy. Apply the epoxy to the joiner wire and to the elevators where the joiner wire is installed. Place the joiner wire into each elevator half and use a paper towel and isopropyl alcohol to remove any excess epoxy. Use low-tack tape to keep the joiner wire in position until the epoxy fully cures. Use a straight edge along the hinge line to keep the elevators aligned while the epoxy cures.

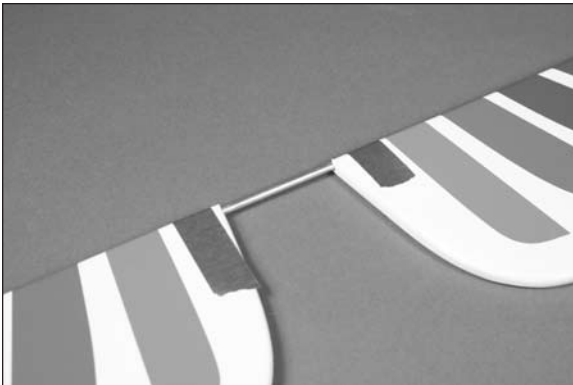

□ 3. Remove the tape from the elevators. Use a drill and 1/16-inch (1.5mm) drill bit to drill a hole in the center of each hinge slot in the elevators and stabilizer. This provides a tunnel for the CA to wick into when installing the hinges, creating a better bond between the hinges and surrounding wood.

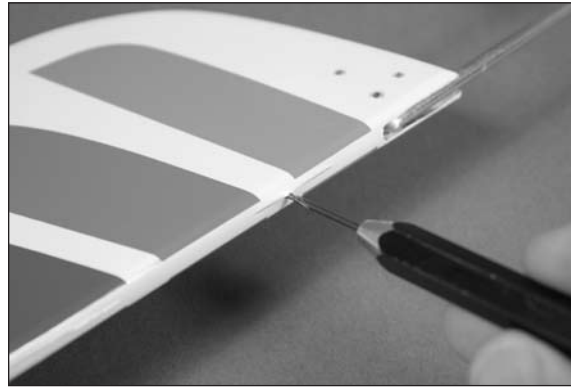

□□ 4. Place a T-pin in the center of the six elevator hinges. This will help center the hinges in the elevator and stabilizer.



□□ 5. Place the hinges in the elevator, resting the T-pin against the leading edge of the elevator.

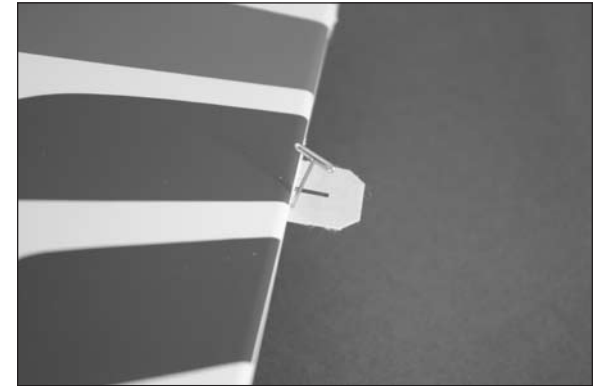

□□ 6. Fit the elevators to the stabilizer. Check that the ends of the elevator and stabilizer align, and that the trim aligns.

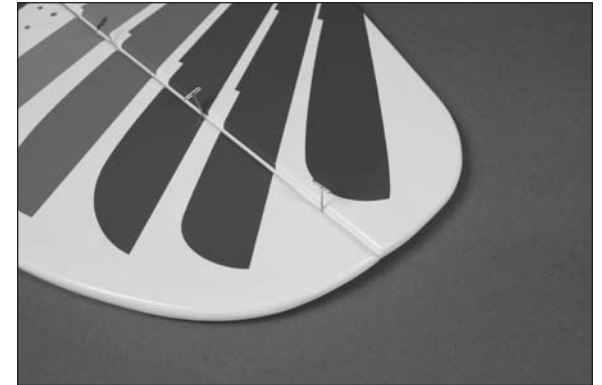

□□ 7. Remove the T-pins from the hinges and make sure the gap between the elevators and stabilizer are as small as possible. Saturate the top and bottom of each hinge using thin CA. Allow the CA to cure before proceeding. Check that the hinges are secure by gently pulling on the control surface. If not, apply thin CA to any hinges that are not glued and recheck. Move the control surface through its range of motion several times to break in the hinges. This will reduce the initial load on the servo during your first flights.

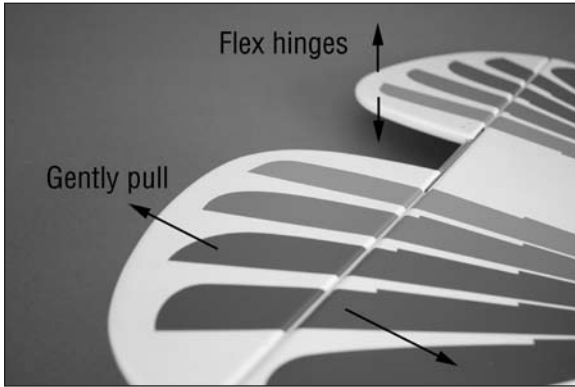

□ 8. Slide the 12mm x 420mm aluminum tube into the bottom wing panel. The tube socket has a cap on it, so do not force the tube in any farther than it will easily slide.



□ 9. Slide the wing into position on the fuselage. Make sure the wing is tight against the fuselage. Slide the remaining wing panel into position tightly against the fuselage. The bottom wing is only installed so it can be used as a reference when installing the stabilizer.

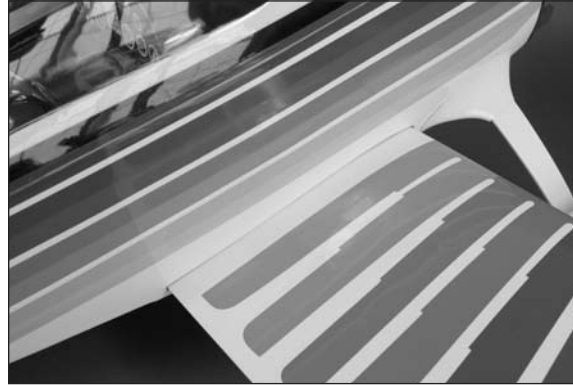

➔ *Incorrectly aligning the stabilizer to the wing will produce an aircraft requiring additional trim to fly correctly and be detrimental to its flight characteristics. Make sure to align the stabilizer as described.*

□ 10. Slide the stabilizer in the slot in the fuselage. Center the stabilizer in the slot. Note that the holes for mounting the control horn are on the right side of the fuselage when viewed from the top.

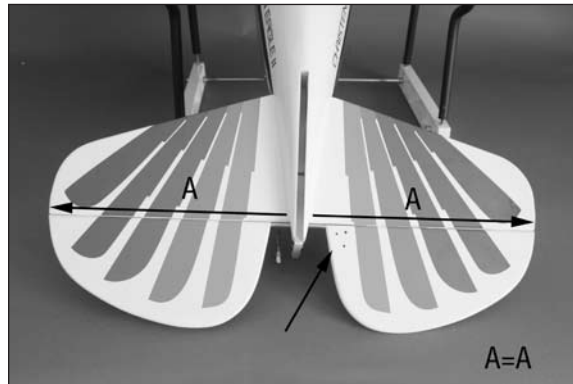

□ 11. Measure from the tip of the stabilizer to the wing tip on both sides. These measurements must match exactly. If they do not, reposition the stabilizer as necessary.

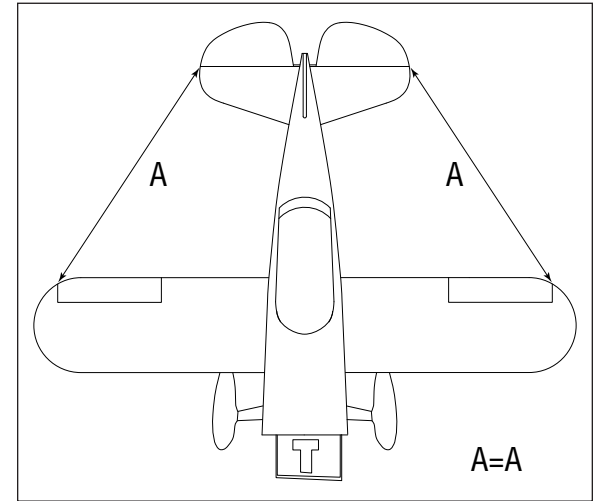

□ 12. Step back 8–10 feet (2–3 meters) and view the airframe from the rear. Check the alignment between the stabilizer and wing to make sure they are aligned equally. If not, lightly sand the stabilizer saddle to correct any alignment issues.

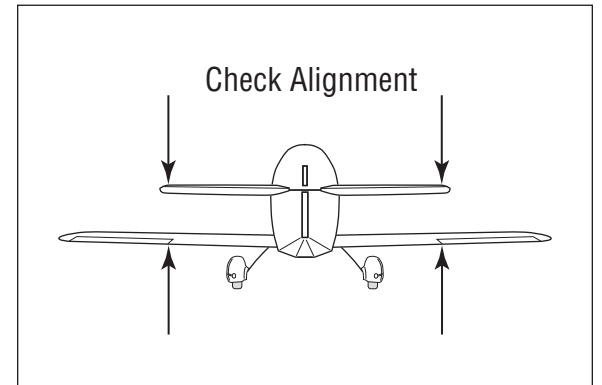

□ 13. Once the stabilizer has been aligned, use a felt-tipped pen to transfer the outline of the fuselage onto the top and bottom of the stabilizer.

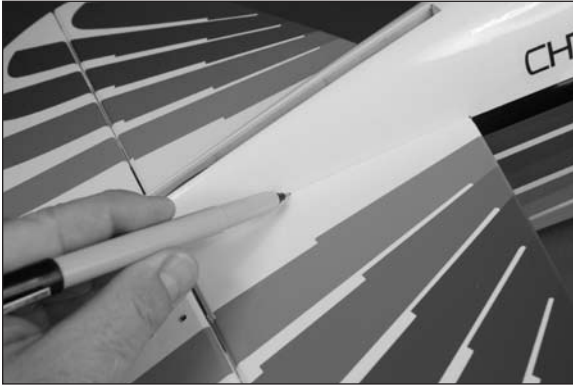

□ 14. Remove the stabilizer from the fuselage. Use a hobby knife and a new #11 blade to trim the covering 1/16-inch (1.5mm) inside the lines drawn in the previous step. Remove the covering, exposing the wood at the center of the stabilizer. Use a paper towel and denatured alcohol to remove the pen lines from the stabilizer and fuselage.

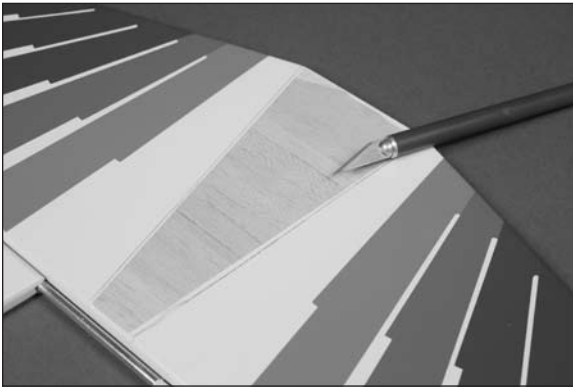

→ *Make sure to use a new #11 blade and use light pressure to trim only the covering. Avoid cutting into the underlying wood, which could weaken the structure of your model.*

□ 15. Mix 1/2 ounce (15mL) of 30-minute epoxy. Apply epoxy to the exposed wood on both the top and bottom of the stabilizer. Slide the stabilizer into position in the fuselage. Use a paper towel and isopropyl alcohol to remove any excess epoxy before it cures. Recheck the alignment of the stabilizer while the epoxy is curing to make sure it doesn't change position in the fuselage. Allow the epoxy to cure before resuming building your model.



□ 16. Remove the wings from the fuselage. Use a small amount of medium CA to glue the black-covered balsa block in position at the rear of the fuselage.

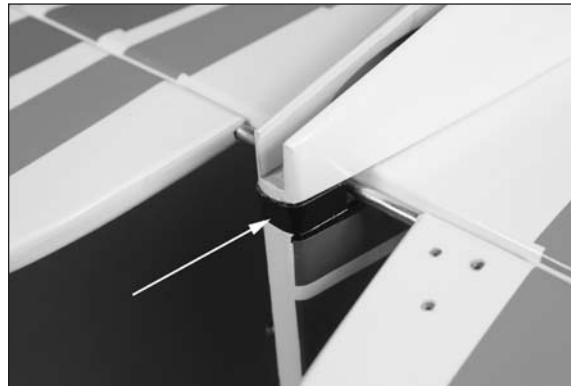

□ 17. Remove the rudder and hinges from the fin. Slide the fin into position on the fuselage. Use a felt-tipped pen to trace the outline of the fuselage on both sides of the fin.



□ 18. Remove the fin from the fuselage. Use a hobby knife and a new #11 blade to trim the covering 1/16 inch (1.5mm) below the lines drawn in the previous step. Remove the covering, exposing the wood at the bottom of the fin. Use a paper towel and denatured alcohol to remove the pen lines from the fin and fuselage.

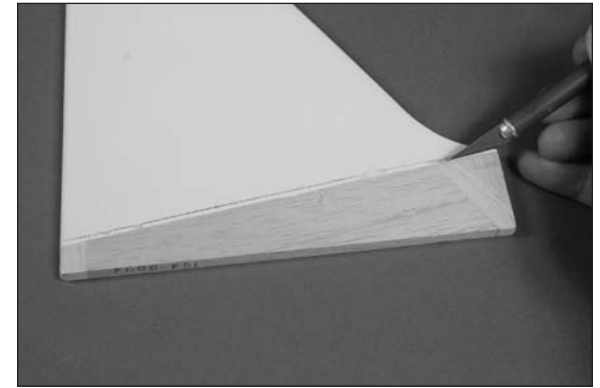

→ *Make sure to use a new #11 blade and use light pressure to trim only the covering. Avoid cutting into the underlying wood, which could weaken the structure of your model.*

□ 19. Mix 1/3 ounce (10mL) of 30-minute epoxy. Apply the epoxy to the exposed wood at the bottom of the fin as well as to the fuselage where the fin will come in contact with the fuselage. Slide the fin into position. Use a paper towel and rubbing alcohol to remove any excess epoxy from the fuselage. Use a square to check the alignment of the fin to the stabilizer. Use low-tack tape, if necessary, to hold the fin in position until the epoxy fully cures. Use a paper towel and rubbing alcohol to remove any excess epoxy before it fully cures.

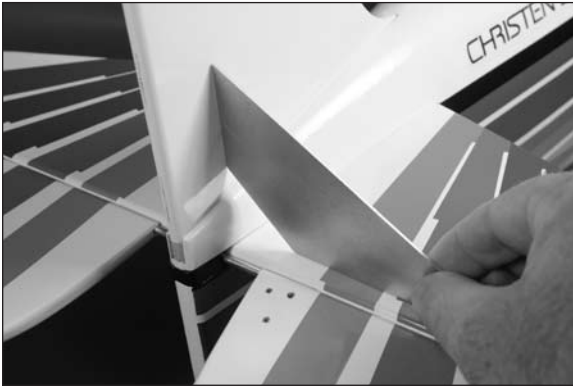

□ 20. Repeat steps 4 through 7 to hinge the rudder to the fin and fuselage. You will need to use a hobby knife with a #11 blade to cut a slot in the fuselage for the bottom hinge on the rudder.

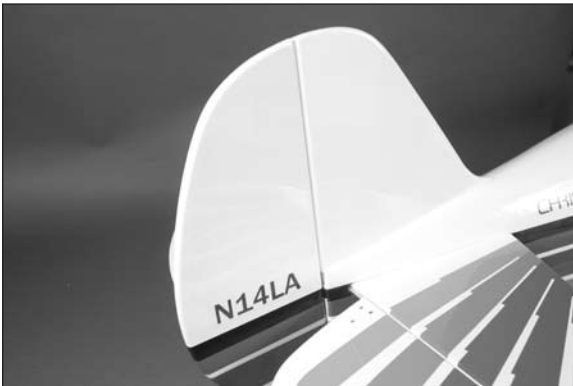

Tail Wheel and Control Horn Installation

Required Parts

Fuselage assembly	Control horn backplate (2)
Control horn (2)	M2 x 12 machine screw (6)
Tail wheel assembly	Steering bracket
N2 nut	M2 x 15 machine screw
M3 x 12 self-tapping screws (2)	

□ 1. Locate the items for this section of the manual.

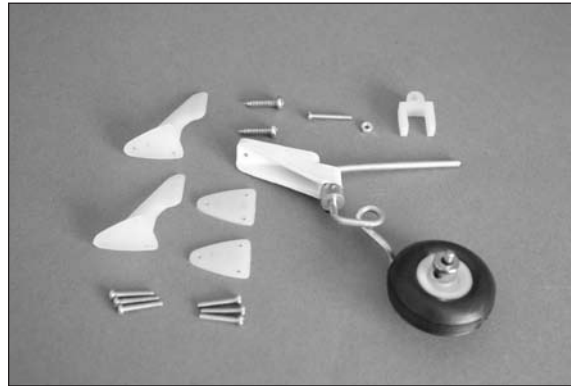

□ 2. Use a #1 Phillips screwdriver to attach the rudder and elevator control horn using three M2 x 12 machine screws and a control horn backplate for each control horn. It may be necessary to use a pin vise and 5/64-inch (2mm) drill bit to clear the holes if any of the hinges are blocking the mounting holes.

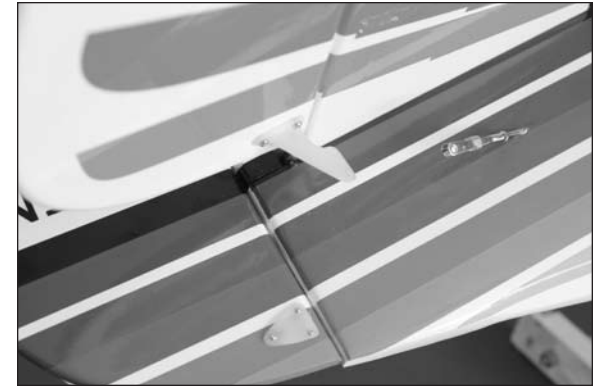
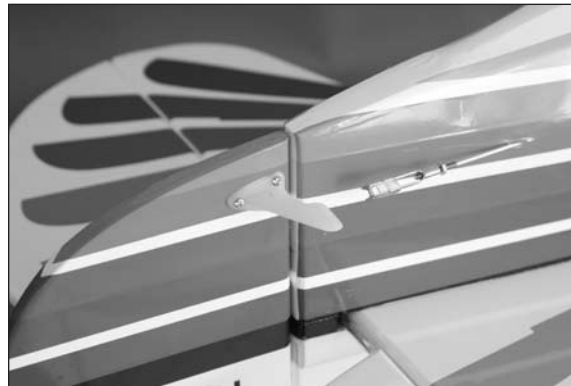

□ 3. Position the tail wheel assembly at the rear of the fuselage so the hinge point of the tiller arm aligns with the rudder hinge line. The holes in the bracket will align with the fuselage center line. Use a felt-tipped pen to mark the location for the two mounting screws on the fuselage.



□ 4. Use a pin vise and 5/64-inch (2mm) drill bit to drill the holes for the mounting screws. Use a #1 Phillips screwdriver to thread an M3 x 12 self-tapping screw in each hole. Remove the screw, then apply 2–3 drops of thin CA in each hole to harden the surrounding wood.



□ 5. Mount the tail wheel bracket using two M3 x 12 self-tapping screws. Use a #1 Phillips screwdriver to tighten the screws.



□ 6. Slide the steering bracket on the tail gear wire so it is positioned 5/8-inch (8mm) from the end of the wire. Use a pin vise and 5/64-inch (2mm) drill bit to drill the hole through the rudder using the hole in the bracket as a guide. Secure the steering bracket using an M2 x 15 machine screw and M2 nut. Tighten the screw using a #1 Phillips screwdriver and 4mm nut driver. Make sure to use threadlock on the nut to prevent it from vibrating loose. Slide the wheel collar against the tail wheel bracket and use a 1.5mm hex wrench to tighten the setscrew, securing the position of the wheel collar.



Radio Installation

Required Parts

Fuselage assembly	Receiver
Receiver battery	Switch harness
Servo with hardware (3)	
3-inch (76mm) servo extension (2)	

□ 1. Remove the canopy from the fuselage. Use a #1 Phillips screwdriver to thread a servo mounting screw in each of the holes in the fuselage for the servo mounting screws. Apply 2–3 drops of thin CA in each hole to harden the surrounding wood.

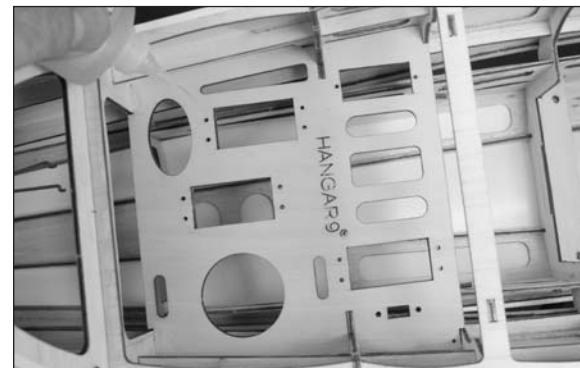

➔ *You do not need to prepare the holes for the throttle servo when building the model for electric power.*

□ 2. Install the grommets and brass eyelets in the rudder and elevator servos. Use the screws provided with the servos to secure them in the fuselage. Make sure the servo output shaft faces the front of the fuselage for both servos. Use a #1 Phillips screwdriver to tighten the screws.



□ 3. Mount the receiver in the fuselage using a hook and loop strap and 1/4 inch (6mm) of foam rubber (not included). Plug the rudder and elevator servo into the appropriate ports of the receiver. Plug a 3-inch (76mm) extension in the ports that will be used for the aileron servos. The remote receiver is mounted using hook and loop tape (not included) inside of the fuselage above the servos. Make sure the antenna of the remote receiver is positioned at a different angle than the main receiver for the best operation of your radio system.



□ 4. Use the radio system to center the rudder and elevator servos. Use a pin vise and 5/64-inch (2mm) drill bit to enlarge the hole 1/2 inch (13mm) from the center of a 4-sided servo horn. Remove the excess arms from the horn so they won't interfere with the operation of the servos. Connect the Z-bend of the rudder and elevator pushrod to the servo horn. Attach the horns to the servos using the screws provided with the servos and a #1 Phillips screwdriver.

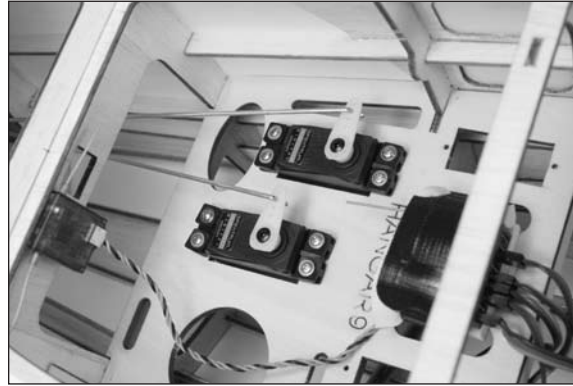

□□ 5. With the radio system on and the elevator servo centered, attach the clevis to the outer hole of the elevator control horn. Adjust the clevis so the elevator is aligned with the stabilizer. Once the clevis is set, slide the silicone retainer over the forks of the clevis to keep the clevis from opening accidentally. Apply threadlock to the nut and clevis to prevent them from vibrating loose. Use pliers to tighten the nut against the clevis to prevent it from vibrating and changing position.



□ 6. Repeat step 5 to connect the clevis to the middle hole of the rudder control horn.



➔ *The following steps illustrate installing the switch harness, battery and throttle servo for the glow-powered version of your model. If you are building for electric power, skip to the next section of the manual to install the aileron servos.*

□ 7. Install the throttle servo in the fuselage using the screws included with the servo and a #1 Phillips screwdriver. The output shaft of the servo faces to the front of the fuselage. Plug the servo into the throttle port of the receiver.



8. Mount the switch harness in the fuselage using the hardware provided with the switch and a #1 Phillips screwdriver. There are two different locations in the fuselage for the switch, so use the one best suited for your switch. Plug the switch into the battery port of the receiver.



9. Wrap the receiver battery in 1/4-inch (6mm) foam. Use a hook and loop strap (not included) to secure the battery in the fuselage. Secure the lead from the battery to the switch harness using string or dental floss so it will not accidentally disconnect inside the fuselage.



Aileron Servo Installation

Required Parts

Control horn (2) M3 nut (4)
 Servo with hardware (2)
 3-inch (76mm) servo extension (2)
 Bottom wing (right and left)
 3mm metal clevis with silicone tubing (4)
 3mm x 70mm threaded rod (2)
 M2 x 12 self-tapping screw (6)

1. Locate the items for this section of the manual.

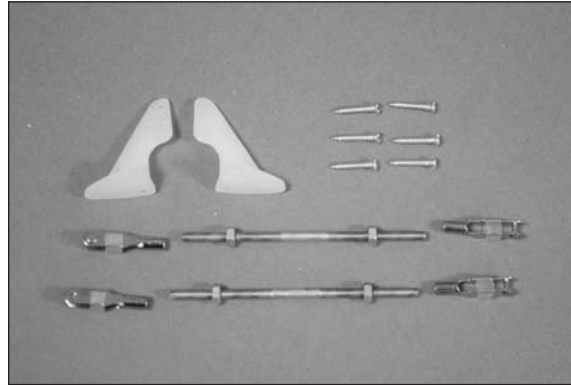

2. Hinge the aileron following the procedure found in the section "Tail Installation." Fit the aileron to the wing. Before gluing the hinges, make sure the ends of the aileron are spaced evenly in the opening.

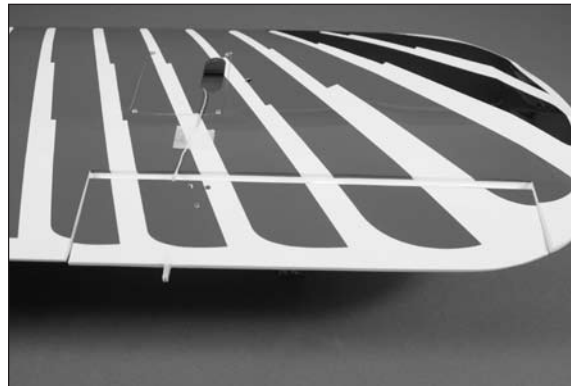

3. Use a #1 Phillips screwdriver to remove the four M2 x 12 self-tapping screws holding the aileron servo cover to the wing. Apply 1–2 drops of thin CA in each screw hole to harden the surrounding wood.



4. Use a #1 Phillips screwdriver to thread a servo mounting screw into each of the holes for mounting the aileron servo. Remove the screw, then apply 1–2 drops of thin CA to each hole to harden the surrounding wood.

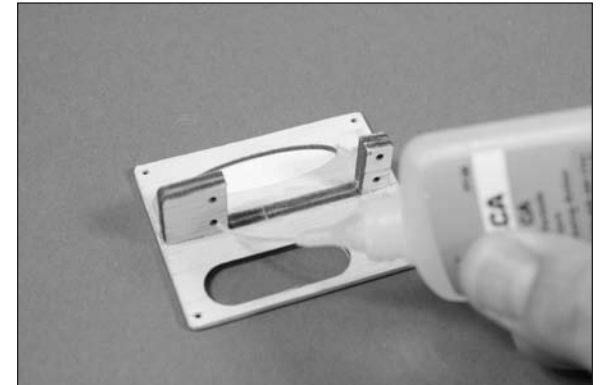

□□ 5. Prepare the aileron servo by installing the grommets and brass eyelets. Use a #1 Phillips screwdriver and the screws included with the servo to secure the servo to the cover. Make sure the output shaft for the servo aligns with the opening in the aileron servo cover.

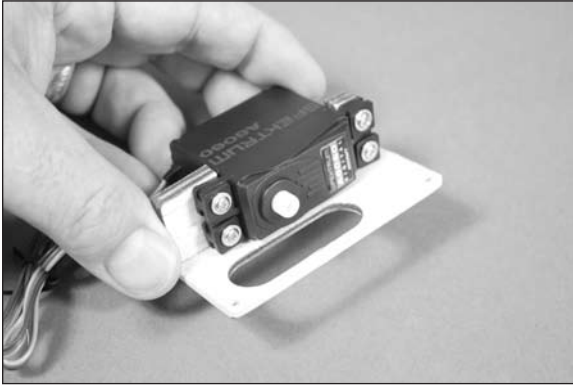

□□ 6. Secure a 3-inch (76mm) servo extension to the aileron servo lead using string or dental floss so it does not disconnect inside the wing accidentally.

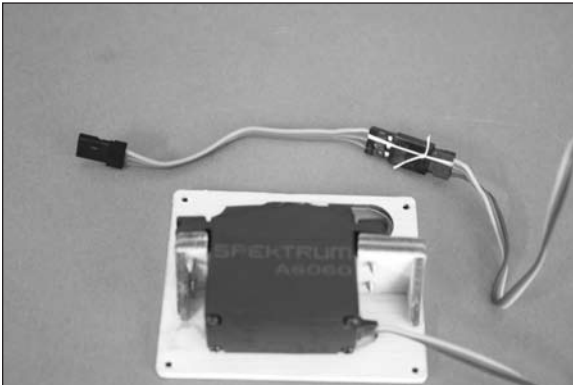

□□ 7. Use the radio system to center the aileron servo. Attach the servo horn so it is perpendicular to the servo center line. Use side cutters to remove any arms from the horn that may interfere with the operation of the servo. The clevis for the aileron pushrod will attach to the hole on a 4-way servo horn that is 19/32 inch (15mm) from the center of the horn.

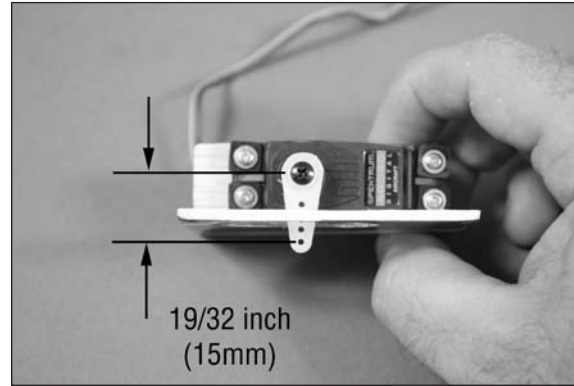

□□ 8. Tie the string located in the wing around the end of the aileron servo extension. Use the string to pull the extension and servo lead through the wing. Secure the aileron servo and cover to the wing using the M2 x 12 self-tapping screws removed in step 3 and a #1 Phillips screwdriver.

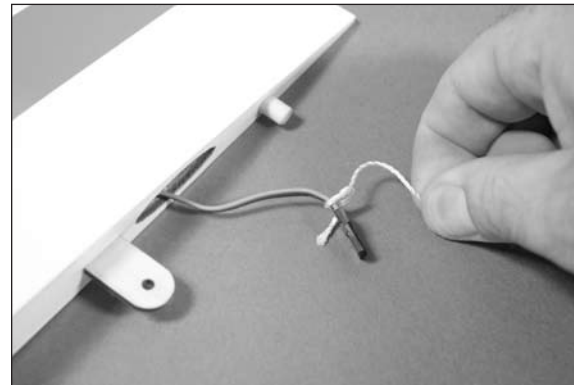

□□ 9. Use a #1 Phillips screwdriver to thread an M2 x 12 self-tapping screw in each of the three control horn mounting holes. Be careful not to thread the screws through the top of the aileron. Remove the screws, then apply 2–3 drops of thin CA in each hole to harden the surrounding wood.

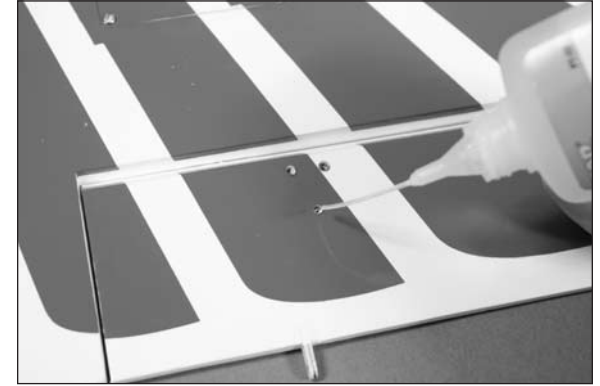

□□ 10. Mount the aileron control horn using three M2 x 12 self-tapping screws and a #1 Phillips screwdriver.

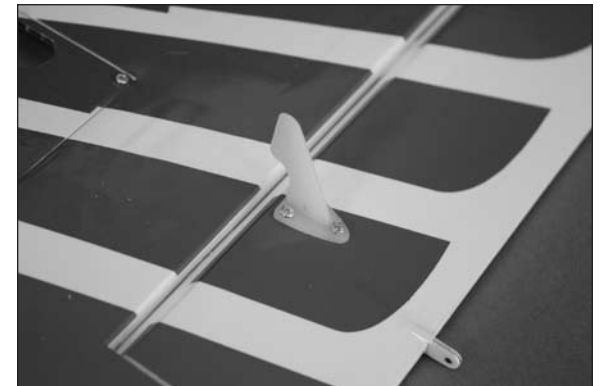

□□ 11. Thread a clevis on each end of the 3mm x 70mm threaded rod. Set the distance between the pins of the clevises so they are $3\frac{5}{8}$ inches (92mm) apart. Make sure each clevis is threaded equally on the rod.

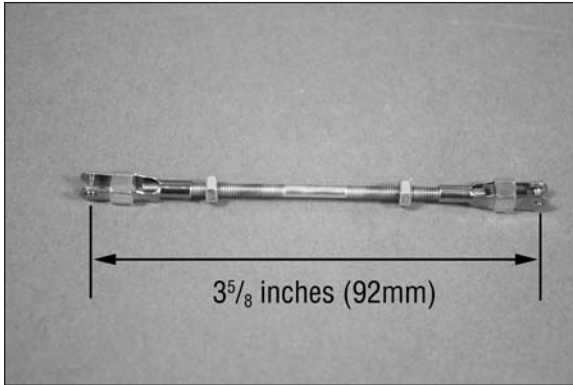

□□ 12. Connect the servo to the control horn using the linkage prepared in the previous step. With the aileron servo centered, fine-tune the length of the linkage so the aileron is centered. Make sure there is an equal amount of thread in each clevis. Once the length of the linkage is set, use pliers to tighten the M3 nuts against the clevises so they don't vibrate and change position. Use threadlock on the nuts and clevises to prevent them from vibrating loose. Slide the silicone retainers over the forks of the clevises so they don't open accidentally in flight.



Cabane Strut Installation

Required Parts

Fuselage assembly	Cabane strut (right and left)
M3 nut (2)	M3 washer (4)
Upper wing center rib	
M3 x 10 socket head screw (6)	

□ 1. Locate the items for this section of the manual.

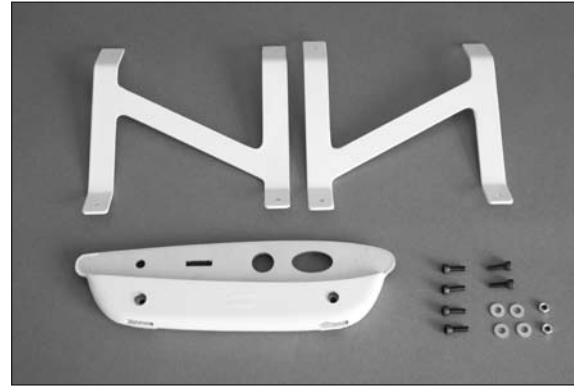

□ 2. Use a hobby knife with a #11 blade to remove the covering on the top of the fuselage so the cabane struts can be inserted into the fuselage. We recommend using a trim seal tool to iron the covering neatly into the openings in the fuselage.

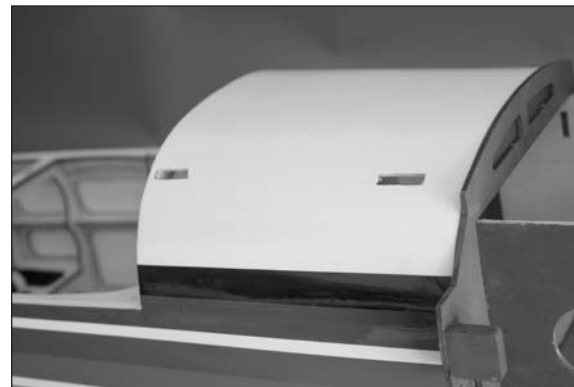

□ 3. Place the cabane struts in position, noting their position as shown in the photo. Loosely install the four M3 x 10 socket head machine screws and M3 washers. Leave the hardware loose so the struts can be positioned while installing the upper wing center rib. Make sure to use threadlock on the screws so they won't vibrate loose.

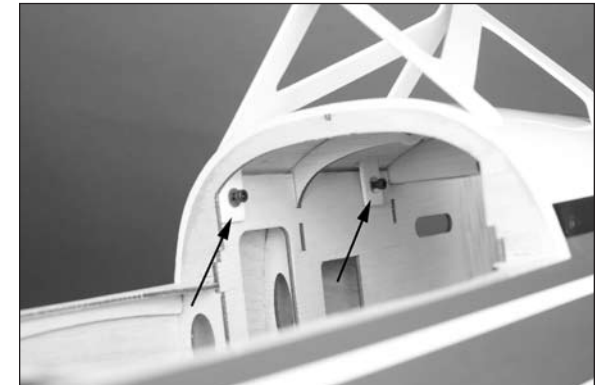

- 4. Place the upper center wing rib in position on the cabane struts. Start the M3 x 10 socket head screws that secure the rib to the cabane struts.



- 5. Use a 2.5mm hex wrench to slowly tighten the hardware securing the cabane struts in position on the fuselage. You may want to use hemostats to hold the M3 nuts when using them to attach the upper center wing rib to the struts. Again, make sure to use threadlock on all the fasteners to prevent them from vibrating loose.

Electric Power Installation

Required Parts

Fuselage assembly	Wood tray
Wood box	M4 blind nut (4)
M3 washer (2)	Hook and loop strap (2)
Plywood engine template	Triangle stock, 300mm
Motor battery (2)	Speed control with connectors
Tie wraps (not included)	
9-inch (228mm) servo extension	
Hook and loop tape (not included)	
Power 90 motor with hardware	
M4 x 25 socket head screw (4)	
M3 x 15 socket head screw (2)	

- 1. Locate the items for this section of the manual.

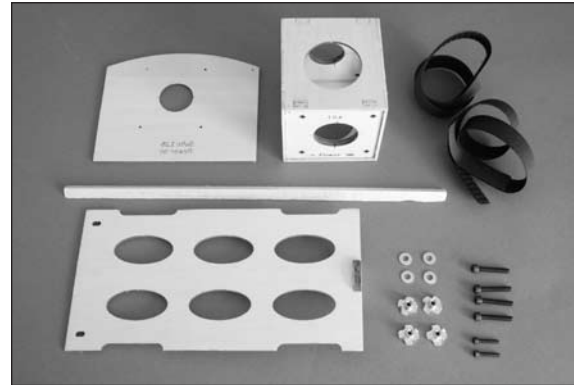

- 2. Place the two hook and loop straps on the wood tray.

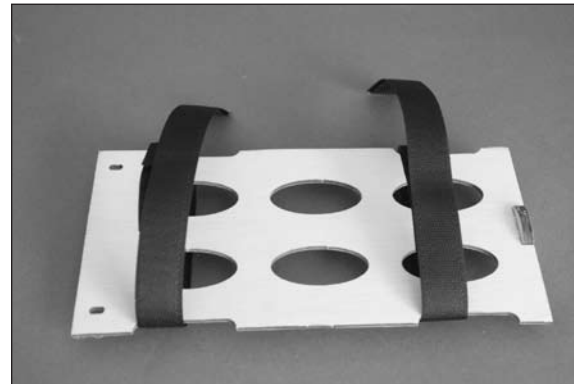

- 3. Place the wood tray in the fuselage, guiding the tab on the tray into the slot near the front of the fuselage. Use two M3 x 15 socket head screws and two M3 washers to secure the tray at the rear. Make sure to use threadlock before tightening the screws, using a 2.5mm hex wrench.

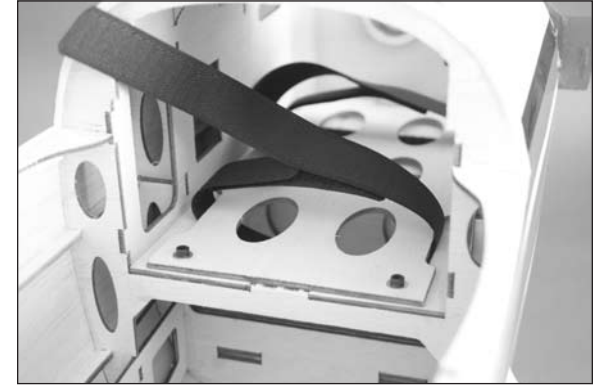

- 4. Use low-tack tape to secure the plywood engine template to the firewall, making sure it is centered. Use a drill and 1/16-inch (1.5mm) drill bit to drill the four pilot holes for the wood box mounting screws.

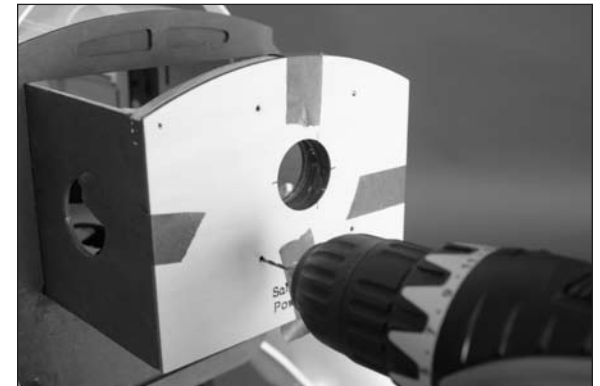

- 5. Remove the template from the fuselage. Use a 7/32-inch (5.5mm) drill bit to enlarge the holes in the firewall.



- 6. Use the four M4 x 25 socket head bolts, four M4 washers and four M4 blind nuts to secure the wood box to the firewall. Tighten the screws using a 3mm hex wrench, making sure to draw the barbs of the blind nuts into the back-side of the firewall. Use threadlock on the screws to prevent them from vibrating loose.



- 7. Use a razor saw to cut the triangle stock to the length of each side of the wood box. Use 5-minute epoxy to glue the pieces to the wood box and firewall. Allow the epoxy to fully cure before proceeding.

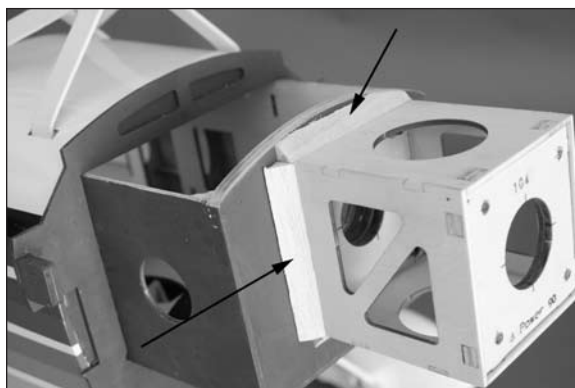

- 8. Prepare the motor following the instructions included with the motor. Attach the motor to the wood box using the hardware included with the motor. Make sure to use threadlock on all metal-to-metal fasteners to prevent them from vibrating loose.

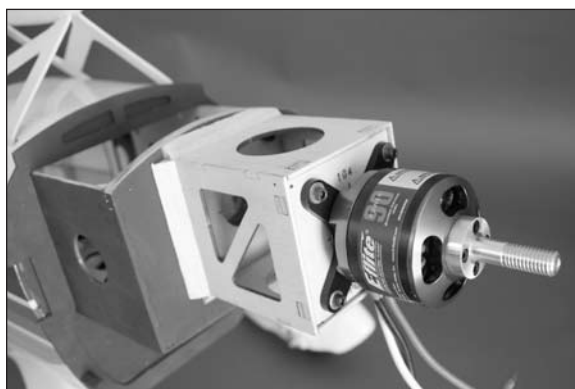

- 9. Solder any necessary connectors on the speed control. Mount the speed control following the suggestions included with the speed control. Connect the speed control to the motor. Use a 9-inch (228mm) servo extension to connect the lead from the speed control to the receiver. Route the motor leads so they don't interfere with the operation of the motor or installation of the cowling.

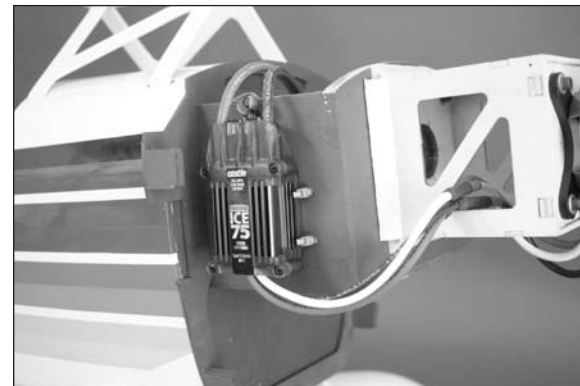

- 10. Secure the two motor batteries in the fuselage using the hook and loop straps. Use hook and loop tape (not included) to keep the batteries from sliding on the plate. Connect the batteries to the speed control using a Y-harness.

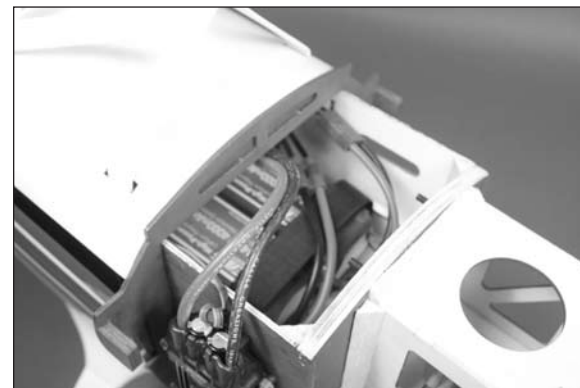

➔ *Once the motor and batteries have been installed, skip to the section "Cowling Installation," as the following sections cover the installation of a glow engine and its related components.*

4-Stroke Engine Installation

Required Parts

Fuselage assembly	Engine mount (right and left)
M4 washer (12)	M4 blind nut (4)
M4 lock nut (4)	M4 x 30 machine screw (8)
Engine	

- 1. Locate the items for this section of the manual.

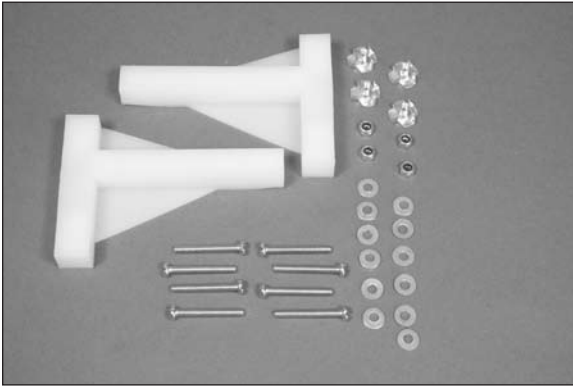

- 2. Use low-tack tape to secure the plywood engine template to the firewall, making sure it is centered. Use a drill and 1/16-inch (1.5mm) drill bit to drill the four pilot holes for the wood box mounting screws.

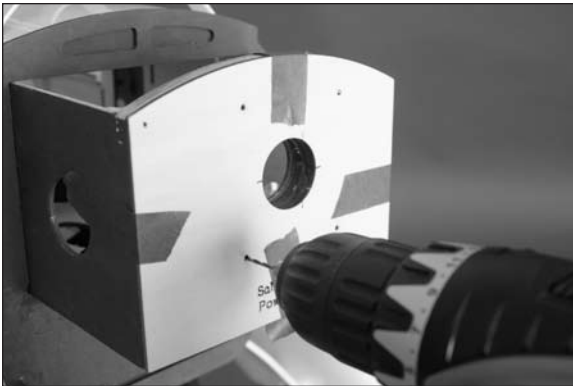

- 3. Remove the template from the fuselage. Use a 7/32-inch (5.5mm) drill bit to enlarge the holes in the firewall.

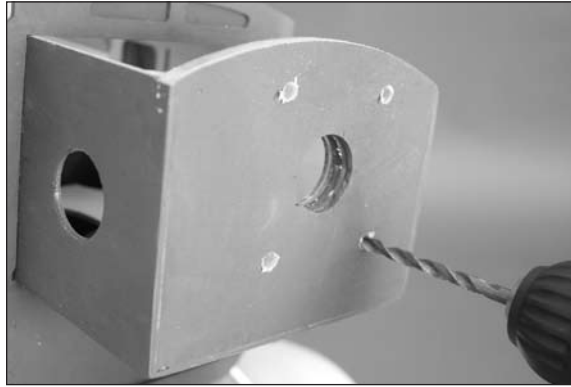

- 4. Use a ruler to measure up 2 inches (51mm) and over 1³/₁₆ inches (30mm). Use a drill and 5/32-inch (4mm) drill bit to drill the hole for the throttle pushrod.

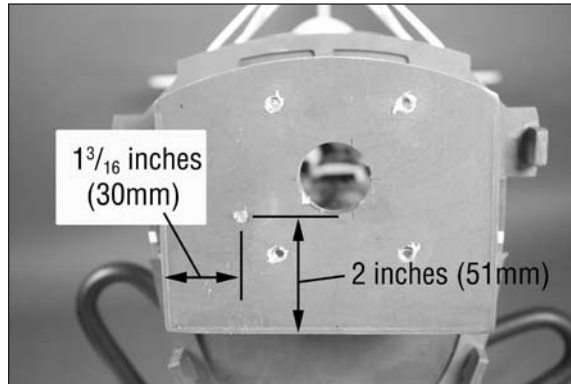

- 5. Attach the right and left engine mounts to the firewall using four M4 x 30 machine screws, four M4 washers and four M4 blind nuts. Note the position of the mounts as shown in the photo with the rails toward the left side of the fuselage. Use a #2 Phillips screwdriver to tighten the bolts, drawing the prongs from the blind nuts into the back-side of the firewall. Make sure to use threadlock on the bolts to prevent them from vibrating loose.

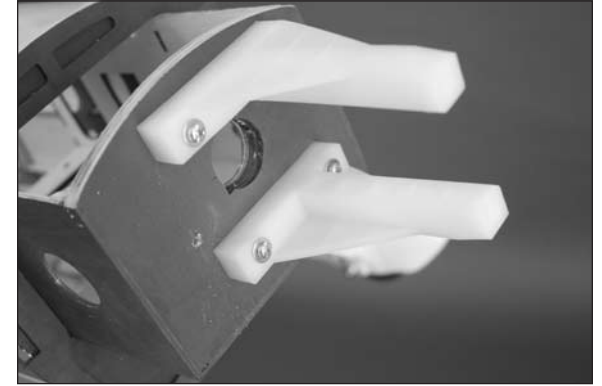

- 6. Check the position of the carburetor on your engine. It may be necessary to turn the carburetor around to match the position shown. Follow the instructions provided with the engine for the correct procedure if necessary.

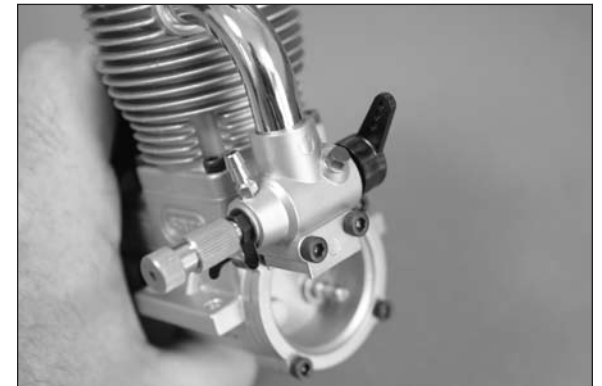

□ 7. Position the engine on the engine mount rails so the face of the drive washer is $5\frac{1}{16}$ inches (145mm) from the firewall. Use a felt-tipped pen to mark the locations for the engine mounting screws on the engine mount rails.

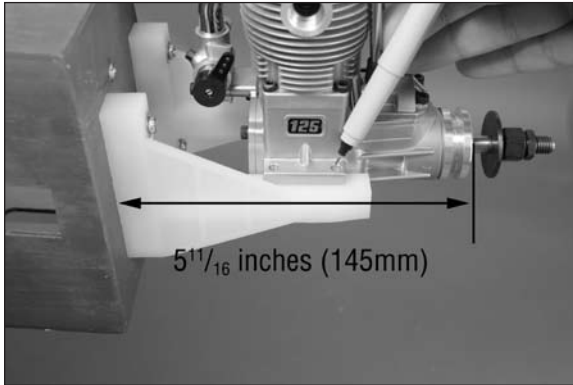

□ 8. Remove the engine. Use a drill and 5/32-inch (4mm) drill bit to drill the holes for the engine mounting hardware in the engine mount rails.



→ We recommend removing the mounts from the firewall and using a drill press to drill the holes for best results.

□ 9. Attach the engine to the engine mount using four M4 x 30 machine screws, four M4 lock nuts and eight M4 washers. Place the washers between the head of the bolts and engine mounting lugs, and between the mount rails and nuts. Use a #2 Phillips screwdriver and 7mm nut driver to tighten the hardware.

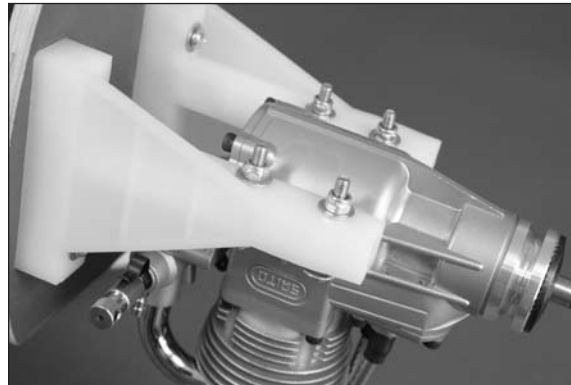

Fuel Tank Installation

Required Parts

Fuselage assembly	Fuel tank
Stopper assembly	Clunk
Fuel tubing, 550mm	Plywood fuel tank former
Plywood fuel tank retainer	

□ 1. Locate the items for this section of the manual.

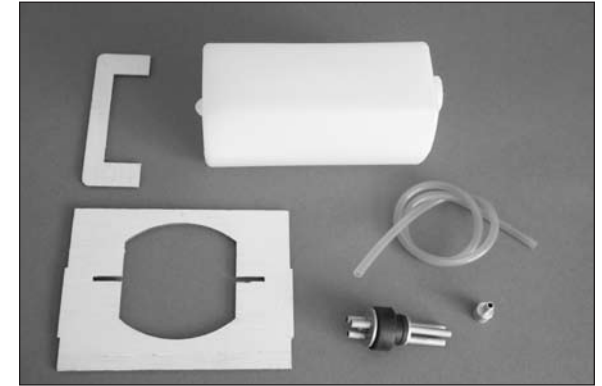

□ 2. Carefully bend the tubes on the stopper. One will be directed toward the top of the tank (vent tube) and the other toward the bottom (fill tube). Use a tubing bender to avoid kinking the tubing while bending.



□ 3. Attach the clunk to the straight line (carburetor tube) using a piece of fuel tubing. Cut the fuel tubing so the distance between the back of the small disk and the end of the clunk measures $4\frac{3}{4}$ inches (120mm) as a starting point.

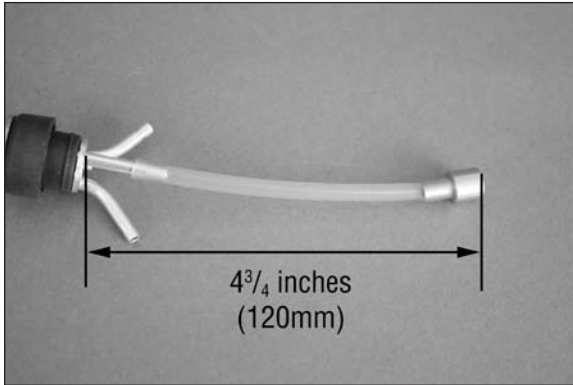

□ 4. Fit the stopper in the fuel tank. It may be necessary to rotate the bent tubes to insert the stopper. The tubes should be close but not touch the top and bottom of the tank. It may be necessary to bend them slightly or even use a short piece of tubing on the tubes to achieve this. Check that the clunk is close to the rear of the tank and can move freely within the tank to allow for consistent fuel draw. Once set, use a #1 Phillips screwdriver to tighten the screw to secure the stopper. Do not over-tighten the stopper and distort or split the neck of the tank.

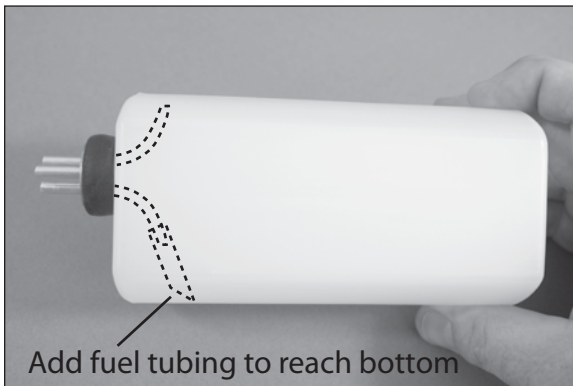

□ 5. Cut three $4\frac{1}{2}$ inch (114mm) pieces of fuel tubing. Attach the fuel tubing to the tubes on the tank.



□ 6. Prepare the plywood fuel tank former by drilling a hole that is $\frac{7}{8}$ inch (22mm) from the side and $\frac{1}{16}$ inch (32mm) from the bottom using a pin vise and $\frac{5}{32}$ -inch (4mm) drill bit. Note the orientation of the former before drilling the hole.

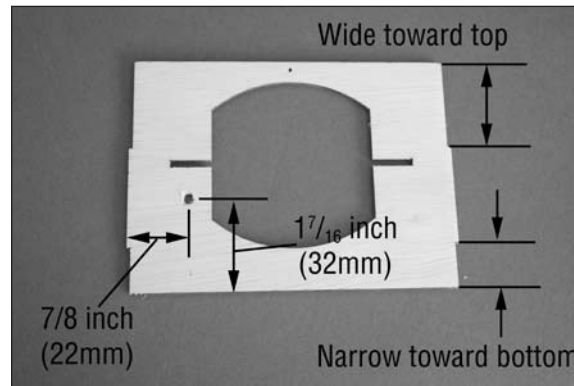

□ 7. Place the former in the fuselage with the hole in the former on the right, lined up with the arm on the carburetor. Position the former in the center of the openings on the sides of the fuselage, but do not glue the former at this time.

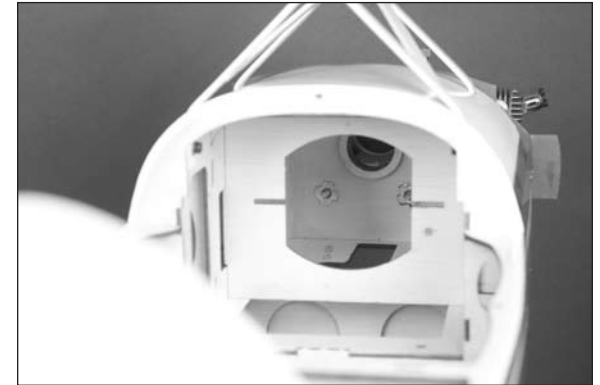

□ 8. Slide the fuel tank into the fuselage, guiding the tubing through the hole in the firewall. Make sure the neck of the tank is seated in the opening of the firewall.



□ 9. Position the plywood fuel tank retainer so the tabs are inserted into the slots on the tank former. The retainer will keep the tank from sliding rearward in the fuselage. The tabs on the retainer should engage the former. If not, reposition the former as necessary. Once the position of the pieces has been set, use medium CA to glue the former to the fuselage and the retainer to the former. It will be necessary to use a hobby knife with a #11 blade to trim the tab off the rear of the fuel tank.



Throttle Pushrod Installation

Required Parts

Fuselage assembly Plywood pushrod standoff
1.5mm x 750mm rod with nylon housing
Pushrod connector with setscrew and m2 nuts

□ 1. Locate the items for this section of the manual.

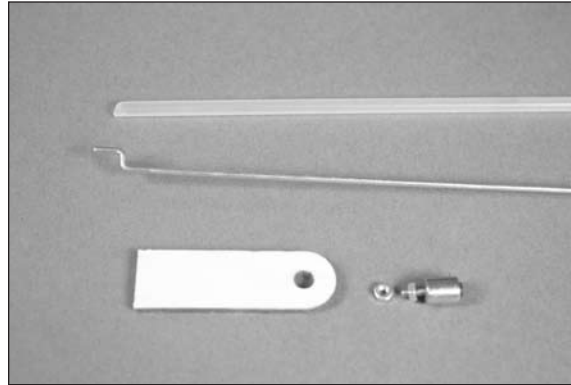

□ 2. Use medium sandpaper to sand three sections that are 1/4 inch (6mm) wide on the pushrod tube. The first is the end of the pushrod. The next two are 5 1/2 inches (140mm) and 9 1/4 inches (324mm) from the end as shown. This will allow the CA to adhere to the pushrod when it is glued into position.

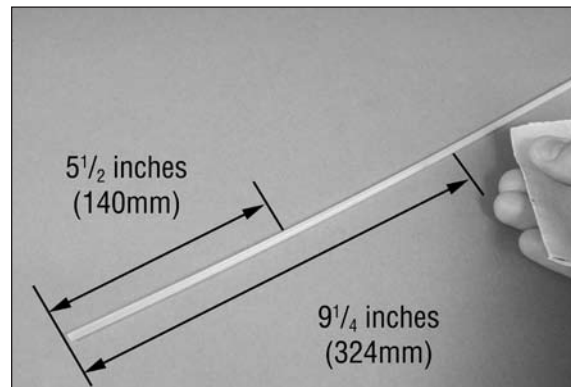

□ 3. Slide the pushrod tube through the holes in the firewall and plywood fuel tank former. Leave 1/16 inch (1.5mm) of the pushrod forward of the firewall. Use medium CA to glue the pushrod into position.



□ 4. Slide the pushrod wire through the tube. The Z-bend in the pushrod will connect to the center hole of the carburetor arm. You may need to remove the engine or arm to connect the wire.

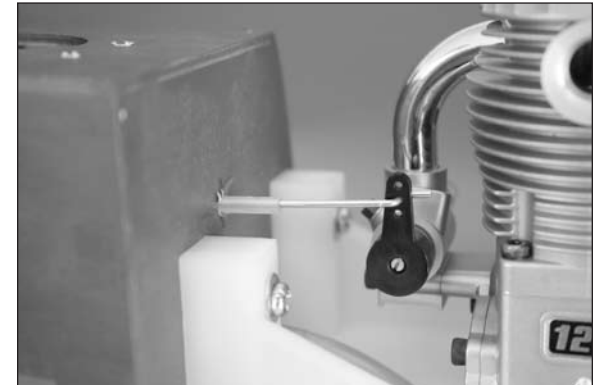

□ 5. Attach the pushrod connector to the servo arm so it is located 5/8 inch (16mm) from the center of the arm. Make sure the connector can rotate freely. Use a drop of medium CA applied with a toothpick to secure the nut on the bottom of the arm.

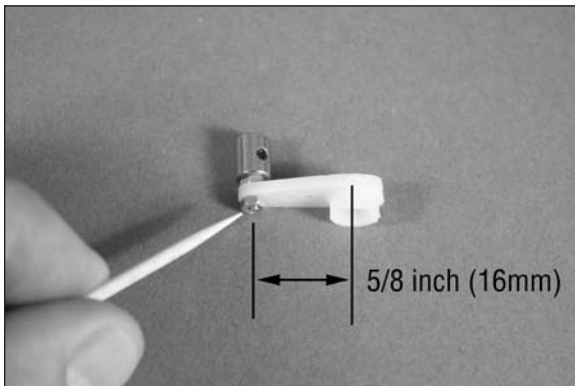

□ 6. Slide the plywood pushrod standoff on the tube. Center the throttle servo and secure the servo arm so it is perpendicular to the servo centerline when the throttle stick and trim are centered. Make sure to slide the pushrod wire through the connector before securing the arm using the screw provided with the servo and a #1 Phillips screwdriver.

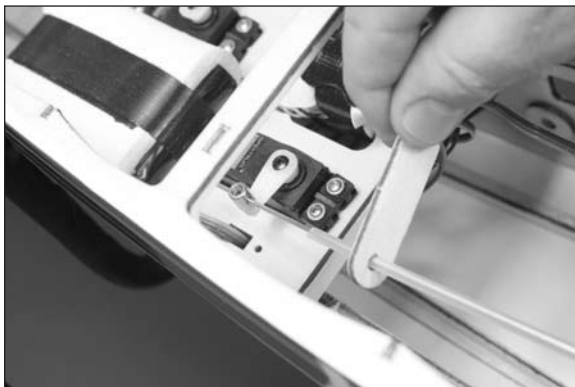

➔ Use wire cutters to trim the length of the wire if necessary. Make sure to leave enough wire to ensure the linkage can be connected properly.

□ 7. Use the radio to move the servo to the fully open position. Move the linkage to open the carburetor. Use a 2mm hex wrench to tighten the setscrew, securing the pushrod wire. Check the operation of the carburetor using the radio system to make sure the throttle moves freely from open to closed. Use the ATV setting in the radio if necessary to make small adjustment.



□ 8. Use medium CA to glue the pushrod standoff to the inside of the fuselage and the pushrod tube.



Cowling Installation

Required Parts (all)

Fuselage assembly	Cowling
Spinner assembly	M3 x 8 self-tapping screw (4)

Required Parts (glow only)

Muffler	Baffle
Fuel dot (not included)	
90-degree muffler header (not included)	
Glow plug adapter (not included)	
Exhaust diverter (not included)	

□ 1. Locate the items for this section of the manual.

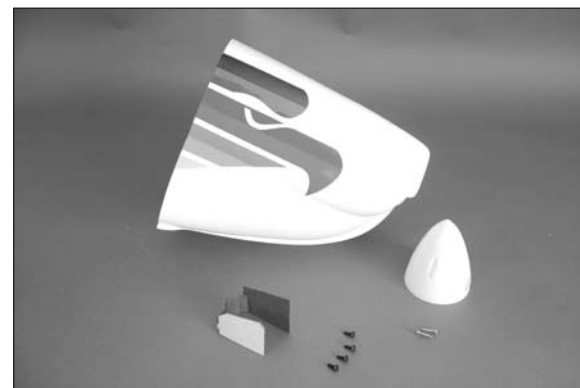

□ 2. Slide the cowling on the fuselage. Place the spinner backplate on the motor shaft so it can be used to align the cowling.



➔ It may be necessary to remove the needle valve when a glow engine has been installed.

- 3. With the spinner backplate tight against the engine drive washer, position the cowl so there is a 1/16-inch (1.5mm) gap between the cowl and spinner backplate. Make sure the gap is even and that the cowl is aligned with the backplate.



- 4. Use a pencil to mark the locations on the cowl mounting blocks.

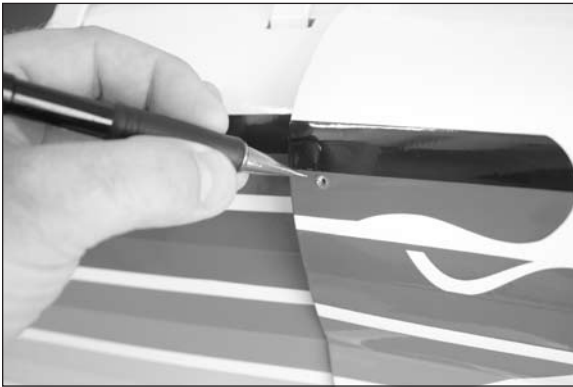

→ Using a small piece of masking tape on the blocks before installing the cowl will make it easier to see the marks.

→ It may be necessary to cut an opening in the cowl to clear the head of the engine or valve covers, depending on your choice of engines.

- 5. Remove the spinner backplate and cowl. Use a drill and 5/32-inch (2mm) drill bit to drill the holes in the cowl mounting blocks for the cowl mounting screws.

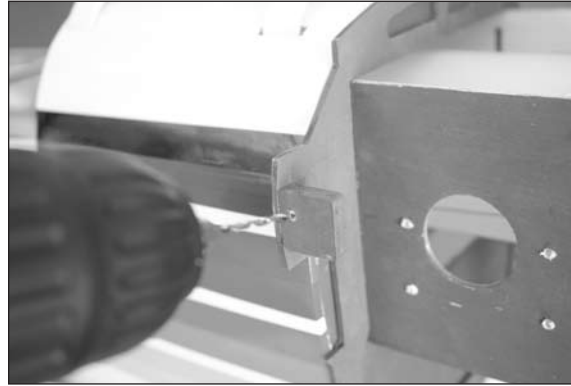

- 6. Use a #1 Phillips screwdriver to thread an M3 x 8 self-tapping screw in each hole. Remove the screw, then apply 2–3 drops of thin CA in each hole to harden the surrounding wood.



→ The following steps are only necessary if you are installing a glow engine in your aircraft. If you have elected to install the EP option, skip to Step 13.

- 7. Use hobby scissors and a rotary tool with a sanding drum to remove material from the bottom of the cowl. The opening should be 4 1/8 inches (105mm) in width and be 3 1/2 inches (90mm) forward of the rear edge of the cowling to provide enough area for air to pass over the engine for cooling.

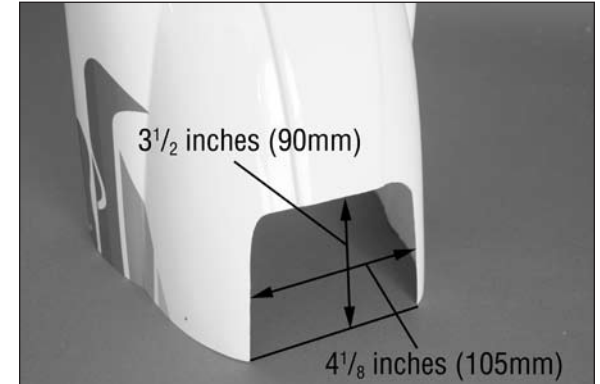

- 8. Use a hobby knife with a #11 blade and a rotary tool with a sanding drum to cut a 1/2-inch (13mm) wide opening from the painted air inlet for air flow into the cowl.



□ 9. Use silicone adhesive to glue the baffle into the cowling to direct air over the head of the engine. Allow the adhesive to fully cure before proceeding. The top and bottom of the baffle should be aligned parallel with the upper and lower edges of the cowl opening.

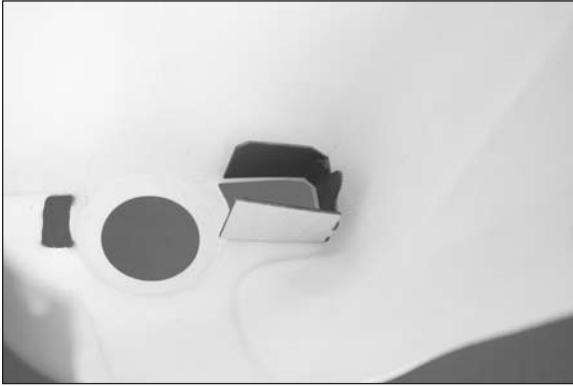

□ 10. Attach the muffler to the engine using a 90 degree exhaust adapter. We also added an exhaust diverter to direct the exhaust out of the bottom of the cowl. Connect the line from the vent to the muffler, and the line from the clunk to the carburetor.

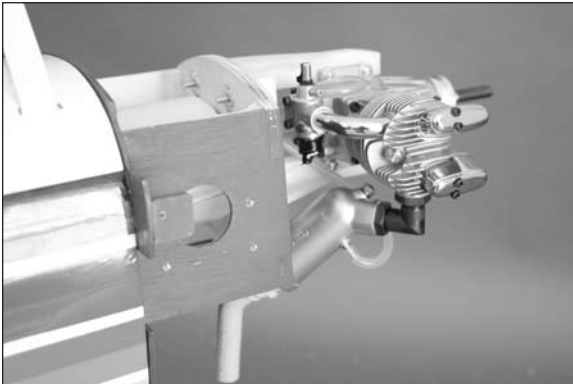

□ 11. At this time you will need to decide if you will be cutting a hole in the cowling for glow plug access, or use a remote adapter so it can be accessed remotely. The adapter is shown here, eliminating the need for a hole in the cowling for the glow plug. The additional weight of the adapter may require tail weight to achieve the desired center of gravity.

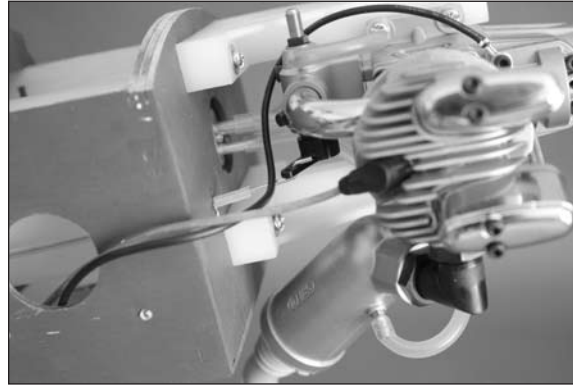

□ 12. Use card stock to locate any items that may need to be accessed from the outside of the cowl.



□ 13. Slide the cowl on the fuselage and use the four M3 x 8 self-tapping screws and a #1 Phillips screwdriver to attach the cowl. Use a felt-tip pen to mark the locations for the items indicated in the previous step.

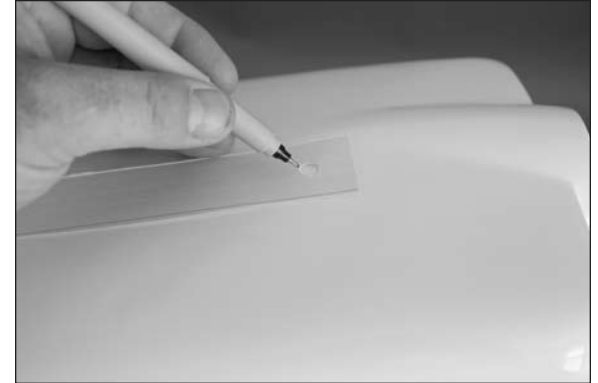

□ 14. Remove the cowl and cut out any areas that were marked in the previous step. Mount the fuel filler dot on the cowl where it can be easily accessed. Place the cowl back on the fuselage and secure it as instructed in the previous step.

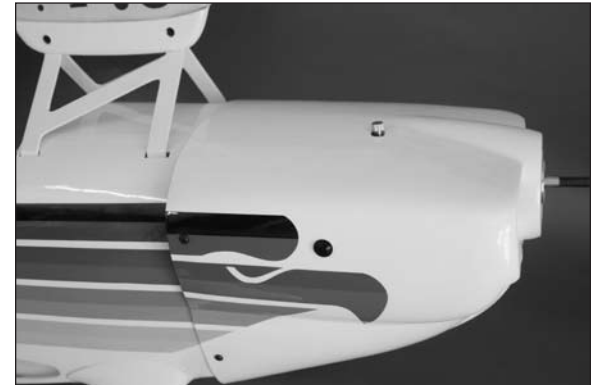

□ 15. Mount the spinner and propeller. Use open-end or box wrenches to tighten the propeller nut. Check the fit of the spinner to the propeller. It may be necessary to trim the opening for the propeller. The propeller must not contact the spinner cone when it is installed. The spinner is held in position using two M3 x 12 self-tapping screws. Tighten the screws using a #1 Phillips screwdriver.



Wing Installation

Required Parts (all)

Fuselage assembly	Aluminum wing tube, 420mm
M3 washer (3)	Aluminum wing tube, 370mm
Interplane strut (2)	M3 x 45 machine screw (4)
M3 nut (4)	
2.6mm x 16mm aluminum pin (8)	
3mm x 270mm threaded rod	
Metal clevis with silicone tubing (4)	
M3 x 10 socket head machine screw (3)	
Wing transport frame with rubber bands (2)	
Bottom wing panel (right and left)	
Top wing panel (right and left)	

□ 1. Locate the items for this section of the manual.

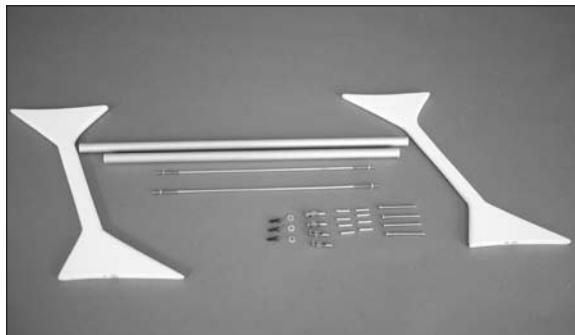

□□ 2. Insert two 2.6mm x 16mm aluminum pins in the bottom of the interplane strut. Use a very small amount of medium CA to secure the pins. Make sure the CA has fully cured before proceeding.



□□ 3. Attach the wing strut to the top of the bottom wing panel using an M3 x 45 machine screw. Use a #1 Phillips screwdriver to tighten the screw.

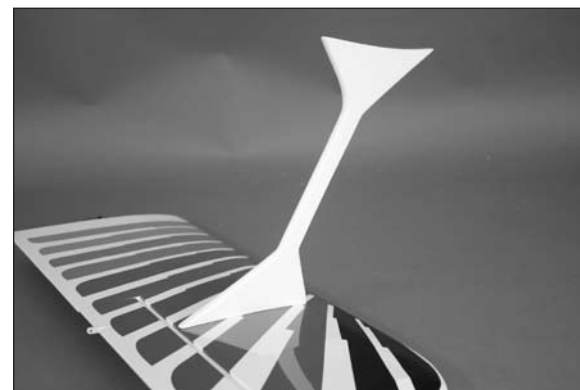

□ 4. Repeat steps 2 and 3 to prepare the remaining wing panel for installation.

□ 5. Slide the 420mm aluminum tube into the bottom wing panel. The tube socket has a cap on it, so do not force the tube in any farther than it will easily slide.



□ 6. Slide the wing into position on the fuselage. Slide the wing tight against the fuselage. Use an M3 x 12 socket head machine screw and M3 washer to secure the wing in position. Use a 2.5mm hex wrench to tighten the screw. Connect the aileron servo extension to the receiver at this time.



□ 7. Attach the remaining bottom wing panel to the fuselage using an M3 x 12 socket head machine screw and M3 washer. Tighten the screw using a 2.5mm hex wrench.

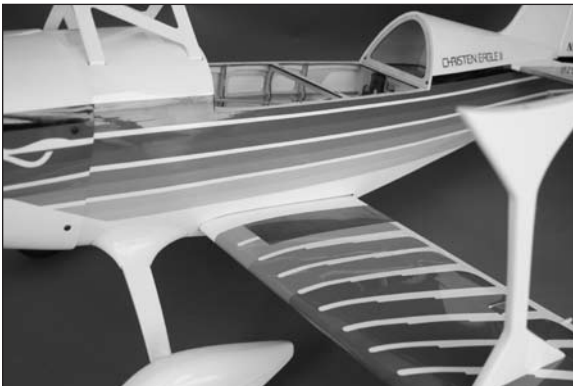

→ When installing the top wing, the pins will be in position in the interplane struts. Use care not to damage the covering on the bottom of the top wing during installation.

□ 8. Place the four remaining 2.6mm x 16mm aluminum pins into the struts. Slide the 370mm aluminum tube into the top wing panel. Slide the tube through the upper center wing rib. Guide the interplane strut into position, then secure it using an M3 x 45mm machine screw and #1 Phillips screwdriver.

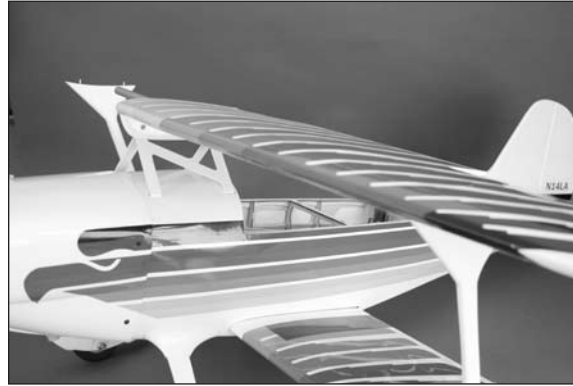

□ 9. Install the remaining top wing panel. Use an M3 x 45 machine screw and #1 Phillips screwdriver to secure the interplane strut. The right and left upper wing panels are connected using an M3 x 12 socket head machine screw and M3 washer. Tighten the screw using a 2.5mm hex wrench.

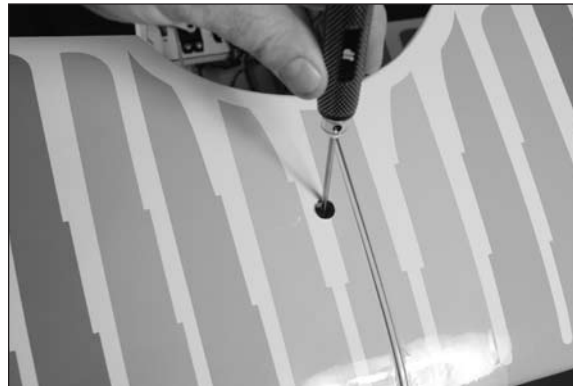

□□ 10. Thread a clevis on each end of a 3mm x 270mm threaded rod. Connect the rod between the top and bottom ailerons. With the radio system on and the bottom aileron centered, adjust the length to center the top aileron. Once centered, slide the silicone tubing over the forks of the clevis to prevent it from opening accidentally. Apply threadlock on the nuts and clevises to prevent them from vibrating loose. Use needle nose pliers to tighten the nut against the clevis to prevent it from vibrating and changing positions.



□ 11. Repeat step 10 to install the remaining aileron linkage. Place the canopy back on the fuselage to complete the assembly of your model.



REMOVING THE WING PANELS

□□ 12. Locate the wing transport frames and rubber bands. Slide the frames between the top and bottom wing as shown. Use a rubber band to hold the frame to the top and bottom wing.



□□ 13. Use a 2.5mm hex wrench to remove the three M3 screws that attach the panels to the fuselage and center section. Slide the panels from the tubes and disconnect the servo lead for the aileron servo.

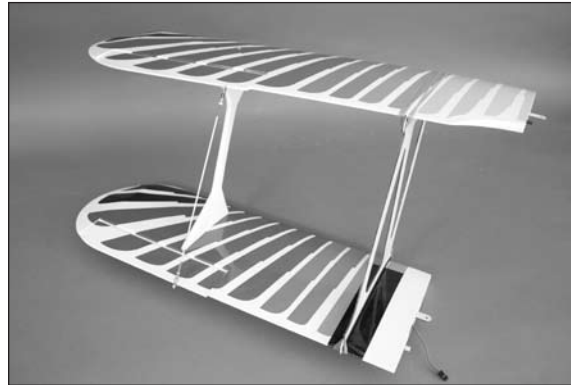

→ Using the transport frames allow the removal of the wings without the need to remove the aileron linkage and the interplane strut between the top and bottom wings.

□ 14. Repeat Steps 12 and 13 to remove the remaining wing panels from the fuselage.

→ To reattach the wings, simply perform Steps 12 through 14 in reverse order.

Center of Gravity

Required Parts

Top wing assembly
Fuselage assembly

Bottom wing assembly

An important part of preparing the aircraft for flight is properly balancing the model.

⚠ CAUTION: Do not inadvertently skip this step!

□ 1. Attach the wings to the fuselage using the M3 hardware as described in the section "Wing Installation." Make sure to connect the leads from the aileron to the appropriate leads from the receiver.

□ 2. The recommended Center of Gravity (CG) location for your model is $5\frac{1}{4}$ inches (133mm) back from the leading edge of the top wing at the center. Mark the location of the CG on the bottom of the wing with a felt-tipped pen.

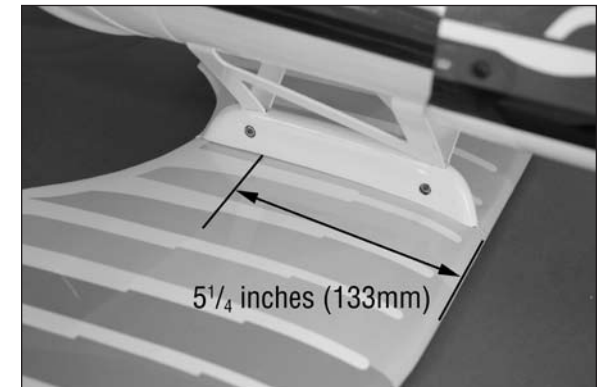

- 3. When balancing your model, make sure it is assembled and ready for flight. Support the plane inverted at the marks made on the wing with your fingers, or use a commercially available balancing stand. This is the correct balance point for your model.

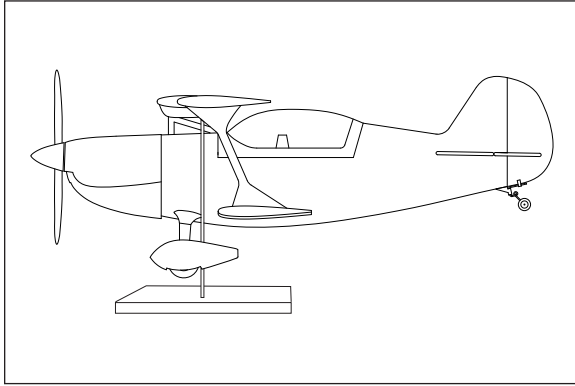

- 4. You should find the CG to be very close with the components installed as shown in this manual. If the nose of your aircraft hangs low, add weight to the rear of the aircraft. If the tail hangs low, add weight to the nose of the aircraft. Self-stick weights (HAN3626) are available at your local hobby store and work well for this purpose.

After the first flights, the CG position can be adjusted for your personal preference. Use a balance point between 5–5½-inch (127mm–140mm) will maintain great flying characteristics.

Moving the CG aft of the rear limit will enhance the model's snap roll and tumbling characteristics, but low speed handling will become more difficult, particularly in the landing phase. Use caution if experimenting with CG positions rearward of the recommended range.

Control Throws

- 1. Turn on the transmitter and receiver of your model. Check the movement of the rudder using the transmitter. When the stick is moved to the right, the rudder should also move right. Reverse the direction of the servo at the transmitter if necessary.
- 2. Check the movement of the elevator with the radio system. Moving the elevator stick toward the bottom of the transmitter will make the airplane elevator move up.
- 3. Check the movement of the ailerons with the radio system. Moving the aileron stick to the right will make the right aileron move up and the left aileron move down.
- 4. Use a ruler to adjust the throw of the elevator, ailerons and rudder.

Aileron:

<i>High Rate:</i>		
Up:	7/8 inches	22 mm
Down:	7/8 inches	22 mm
<i>Low Rate:</i>		
Up:	19/32 inches	15 mm
Down:	19/32 inches	15 mm

Elevator:

<i>High Rate:</i>		
Up:	1¾ inches	35 mm
Down:	1¾ inches	35 mm
<i>Low Rate:</i>		
Up:	1 inches	25 mm
Down:	1 inches	25 mm

Rudder:

<i>High Rate:</i>		
Right:	1⅞ inches	47 mm
Left:	1⅞ inches	47 mm
<i>Low Rate:</i>		
Right:	1¾ inches	35 mm
Left:	1¾ inches	35 mm

These are general guidelines measured from our own flight tests. You can experiment with higher rates to match your preferred style of flying.

➔ *Travel Adjust and Sub-Trims are not listed and should be adjusted according to each individual model and preference. Always install the control horns 90 degrees to the servo centerline. Use sub-trim as a last resort to center the servos.*

➔ *We highly recommend re-binding the radio system once all the control throws are set. This will keep the servos from moving to their endpoints until the transmitter and receiver connect.*

Preflight

Check Your Radio

Before going to the field, ensure your batteries are fully charged per your radio's instructions. Charge the transmitter and motor battery for your airplane. Use the recommended charger supplied with your particular radio system, following the instructions provided with the radio. In most cases, the radio should be charged the night before going out flying.

Prior to each flying session, make sure to range check your radio. See your radio manual for the recommended range and instructions for your radio system. Each radio manufacturer specifies different procedures for their radio systems. Next, run the motor. With the model securely anchored, check the range again. The range test should not be significantly affected. If it is, don't attempt to fly! Have your radio equipment checked out by the manufacturer.

Double-check that all controls (aileron, elevator, rudder and throttle) move in the correct direction.

Check the radio installation and make sure all the control surfaces are moving correctly (i.e., the correct direction and with the recommended throws).

Check all the control horns, servo horns, and clevises to make sure they are secure and in good condition.

Range Test Your Radio

Before each flying session, and especially with a new model, it is important to perform a range check. It is helpful to have another person available to assist during the range check. If you are using a Spektrum transmitter, please refer to your transmitter's manual for detailed instructions on the range check process.

Safety Do's and Don'ts for Pilots

- Consult local laws and ordinances before choosing a location to fly your aircraft.
- Check all control surfaces prior to each takeoff.
- Do not fly your model near spectators, parking areas or any other area that could result in injury to people or damage of property.
- Do not fly during adverse weather conditions. Poor visibility can cause disorientation and loss of control of your aircraft. Strong winds can cause similar problems.
- Do not take chances. If at any time during flight you observe any erratic or abnormal operation, land immediately and do not resume flight until the cause of the problem has been ascertained and corrected. Safety can never be taken lightly.
- Do not fly near power lines.

Daily Flight Checks

- 1. Check the battery voltage of the transmitter battery. Do not fly below the manufacturer's recommended voltage. To do so can crash your aircraft.

When you check these batteries, ensure you have the polarities correct on your expanded scale voltmeter.

- 2. Check all hardware (linkages, screws, nuts, and bolts) prior to each day's flight. Ensure that binding does not occur and that all parts are properly secured.
- 3. Ensure all surfaces are moving in the proper manner.
- 4. Perform a ground range check before each day's flying session.
- 5. Prior to starting your aircraft, turn off your transmitter, then turn it back on. Do this each time you start your aircraft. If any critical switches are on without your knowledge, the transmitter alarm will sound a warning.
- 6. Check that all trim levers are in the proper location.
- 7. All servo pigtailed and switch harness plugs should be secured in the receiver. Make sure the switch harness moves freely in both directions.

Limited Warranty

WHAT THIS WARRANTY COVERS

Horizon Hobby, Inc. ("Horizon") warrants to the original purchaser that the product purchased (the "Product") will be free from defects in materials and workmanship at the date of purchase.

WHAT IS NOT COVERED

This warranty is not transferable and does not cover (i) cosmetic damage, (ii) damage due to acts of God, accident, misuse, abuse, negligence, commercial use, or due to improper use, installation, operation or maintenance, (iii) modification of or to any part of the Product, (iv) attempted service by anyone other than a Horizon Hobby authorized service center, or (v) Products not purchased from an authorized Horizon dealer.

OTHER THAN THE EXPRESS WARRANTY ABOVE, HORIZON MAKES NO OTHER WARRANTY OR REPRESENTATION, AND HEREBY DISCLAIMS ANY AND ALL IMPLIED WARRANTIES, INCLUDING, WITHOUT LIMITATION, THE IMPLIED WARRANTIES OF NON-INFRINGEMENT, MERCHANTABILITY AND FITNESS FOR A PARTICULAR PURPOSE. THE PURCHASER ACKNOWLEDGES THAT THEY ALONE HAVE DETERMINED THAT THE PRODUCT WILL SUITABLY MEET THE REQUIREMENTS OF THE PURCHASER'S INTENDED USE.

PURCHASER'S REMEDY

Horizon's sole obligation and purchaser's sole and exclusive remedy shall be that Horizon will, at its option, either (i) service, or (ii) replace, any Product determined by Horizon to be defective. Horizon reserves the right to inspect any and all Product(s) involved in a warranty claim. Service or replacement decisions are at the sole discretion of Horizon. Proof of purchase is required for all warranty claims. SERVICE OR REPLACEMENT AS PROVIDED UNDER THIS WARRANTY IS THE PURCHASER'S SOLE AND EXCLUSIVE REMEDY.

LIMITATION OF LIABILITY

HORIZON SHALL NOT BE LIABLE FOR SPECIAL, INDIRECT, INCIDENTAL OR CONSEQUENTIAL DAMAGES, LOSS OF PROFITS OR PRODUCTION OR COMMERCIAL LOSS IN ANY WAY, REGARDLESS OF WHETHER SUCH CLAIM IS BASED IN CONTRACT, WARRANTY, TORT, NEGLIGENCE, STRICT LIABILITY OR ANY OTHER THEORY OF LIABILITY, EVEN IF HORIZON HAS BEEN ADVISED OF THE POSSIBILITY OF SUCH DAMAGES. Further, in no event shall the liability of Horizon exceed the individual price of the Product on which liability is asserted. As Horizon has no control over use, setup, final assembly, modification or misuse, no liability shall be assumed nor accepted for any resulting damage or injury. By the act of use, setup or assembly, the user accepts all resulting liability. If you as the purchaser or user are not prepared to accept the liability associated with the use of the Product, purchaser is advised to return the Product immediately in new and unused condition to the place of purchase.

LAW

These terms are governed by Illinois law (without regard to conflict of law principals). This warranty gives you specific legal rights, and you may also have other rights which vary from state to state. Horizon reserves the right to change or modify this warranty at any time without notice.

Warranty Services

QUESTIONS, ASSISTANCE, AND SERVICES

Your local hobby store and/or place of purchase cannot provide warranty support or service. Once assembly, setup or use of the Product has been started, you must contact Horizon directly. This will enable Horizon to better answer your questions and service you in the event that you may need any assistance. For questions or assistance, please direct your email to productsupport@horizonhobby.com, or call 877.504.0233 toll free to speak to a Product Support representative. You may also find information on our website at www.horizonhobby.com.

INSPECTION OR SERVICES

If this Product needs to be inspected or serviced, please use the Horizon Online Service Request submission process found on our website or call Horizon to obtain a Return Merchandise Authorization (RMA) number. Pack the Product securely using a shipping carton. Please note that original boxes may be included, but are not designed to withstand the rigors of shipping without additional protection. Ship via a carrier that provides tracking and insurance for lost or damaged parcels, as Horizon is not responsible for merchandise until it arrives and is accepted at our facility. An Online Service Request is available at <http://www.horizonhobby.com> under the Support tab. If you do not have internet access, please contact Horizon Product Support to obtain a RMA number along with instructions for submitting your product for service. When calling Horizon, you will be asked to provide your complete name, street address, email address and phone number where you can be reached during business hours. When sending product into Horizon, please include your RMA number, a list of the included items, and a brief summary of the problem. A copy of your original sales receipt must be included for warranty consideration. Be sure your name, address, and RMA number are clearly written on the outside of the shipping carton.

Notice: Do not ship LiPo batteries to Horizon. If you have any issue with a LiPo battery, please contact the appropriate Horizon Product Support office.

WARRANTY REQUIREMENTS

For Warranty consideration, you must include your original sales receipt verifying the proof-of-purchase date. Provided warranty conditions have been met, your Product will be serviced or replaced free of charge. Service or replacement decisions are at the sole discretion of Horizon.

NON-WARRANTY SERVICE

Should your service not be covered by warranty service will be completed and payment will be required without notification or estimate of the expense unless the expense exceeds 50% of the retail purchase cost. By submitting the item for service you are agreeing to payment of the service without notification. Service estimates are available upon request. You must include this request with your item submitted for service. Non-warranty service estimates will be billed a minimum of ½ hour of labor. In addition you will be billed for return freight. Horizon accepts money orders and cashiers checks, as well as Visa, MasterCard, American Express, and Discover cards. By submitting any item to Horizon for service, you are agreeing to Horizon's Terms and Conditions found on our website <http://www.horizonhobby.com/Service/Request>.

UNITED STATES

(Electronics and engines)

Horizon Service Center
4105 Fieldstone Rd
Champaign, Illinois
61822 USA

productsupport@horizonhobby.com
877-504-0233

Online Repair Request visit:
www.horizonhobby.com/service

(All other products)

Horizon Product Support
4105 Fieldstone Rd
Champaign, Illinois
61822 USA

productsupport@horizonhobby.com
877-504-0233

UNITED KINGDOM

Horizon Hobby Limited
Units 1-4 Ployters Rd
Staple Tye
Harlow, Essex
CM18 7NS
United Kingdom
sales@horizonhobby.co.uk
+44 (0) 1279 641 097

GERMANY

Horizon Technischer Service
Hamburger Str. 10
25335 Elmshorn
Germany
service@horizonhobby.de
+49 4121 46199 66

FRANCE

Horizon Hobby SAS
14 Rue Gustave Eiffel
Zone d'Activité du Réveil Matin
91230 Montgeron
+33 (0) 1 60 47 44 70

Compliance Information for the European Union



INSTRUCTIONS FOR DISPOSAL OF WEEE BY USERS IN THE EUROPEAN UNION

This product must not be disposed of with other waste. Instead, it is the user's responsibility to dispose of their waste equipment by handing it over to a designated collection point for the recycling of waste electrical and electronic equipment. The separate collection and recycling of your waste equipment at the time of disposal will help to conserve natural resources and ensure that it is recycled in a manner that protects human health and the environment. For more information about where you can drop off your waste equipment for recycling, please contact your local city office, your household waste disposal service or where you purchased the product.

Academy of Model Aeronautics National Model Aircraft Safety Code

Effective January 1, 2011

A. GENERAL

A model aircraft is a non-human-carrying aircraft capable of sustained flight in the atmosphere. It may not exceed limitations of this code and is intended exclusively for sport, recreation and/or competition. All model flights must be conducted in accordance with this safety code and any additional rules specific to the flying site.

1. Model aircraft will not be flown:
 - (a) In a careless or reckless manner.
 - (b) At a location where model aircraft activities are prohibited.
2. Model aircraft pilots will:
 - (a) Yield the right of way to all man carrying aircraft.
 - (b) See and avoid all aircraft and a spotter must be used when appropriate. (AMA Document #540-D-See and Avoid Guidance.)
 - (c) Not fly higher than approximately 400 feet above ground level within three (3) miles of an airport, without notifying the airport operator.
 - (d) Not interfere with operations and traffic patterns at any airport, heliport or seaplane base except where there is a mixed use agreement.
 - (e) Not exceed a takeoff weight, including fuel, of 55 pounds unless in compliance with the AMA Large Model Aircraft program. (AMA Document 520-A)
 - (f) Ensure the aircraft is identified with the name and address or AMA number of the owner on the inside or affixed to the outside of the model aircraft. (This does not apply to model aircraft flown indoors).
 - (g) Not operate aircraft with metal-blade propellers or with gaseous boosts except for helicopters operated under the provisions of AMA Document #555.
 - (h) Not operate model aircraft while under the influence of alcohol or while using any drug which could adversely affect the pilot's ability to safely control the model.
 - (i) Not operate model aircraft carrying pyrotechnic devices which explode or burn, or any device which propels a projectile or drops any object that creates a hazard to persons or property.

Exceptions:

- Free Flight fuses or devices that burn producing smoke and are securely attached to the model aircraft during flight.

- Rocket motors (using solid propellant) up to a G-series size may be used provided they remain attached to the model during flight. Model rockets may be flown in accordance with the National Model Rocketry Safety Code but may not be launched from model aircraft.
- Officially designated AMA Air Show Teams (AST) are authorized to use devices and practices as defined within the Team AMA Program Document (AMA Document #718).
 - (j) Not operate a turbine-powered aircraft, unless in compliance with the AMA turbine regulations. (AMA Document #510-A).
- 3. Model aircraft will not be flown in AMA sanctioned events, air shows or model demonstrations unless:
 - (a) The aircraft, control system and pilot skills have successfully demonstrated all maneuvers intended or anticipated prior to the specific event.
 - (b) An inexperienced pilot is assisted by an experienced pilot.
- 4. When and where required by rule, helmets must be properly worn and fastened. They must be OSHA, DOT, ANSI, SNELL or NOCSAE approved or comply with comparable standards.

B. RADIO CONTROL (RC)

1. All pilots shall avoid flying directly over unprotected people, vessels, vehicles or structures and shall avoid endangerment of life and property of others.
2. A successful radio equipment ground-range check in accordance with manufacturer's recommendations will be completed before the first flight of a new or repaired model aircraft.
3. At all flying sites a safety line(s) must be established in front of which all flying takes place (AMA Document #706-Recommended Field Layout):
 - (a) Only personnel associated with flying the model aircraft are allowed at or in front of the safety line.
 - (b) At air shows or demonstrations, a straight safety line must be established.
 - (c) An area away from the safety line must be maintained for spectators.
 - (d) Intentional flying behind the safety line is prohibited.
4. RC model aircraft must use the radio-control frequencies currently allowed by the Federal Communications Commission (FCC). Only individuals properly licensed by the FCC are authorized to operate equipment on Amateur Band frequencies.
5. RC model aircraft will not operate within three (3) miles of any pre-existing flying site without a frequency-management agreement (AMA Documents #922- Testing for RF Interference; #923- Frequency Management Agreement)



© 2011 Horizon Hobby, Inc.
horizonhobby.com
Hangar9.com

Hangar 9, Evolution, JR, DSM2, DSMX, PowerPro, EC3, UltraCote and the Horizon Hobby logo are trademarks or registered trademarks of Horizon Hobby, Inc.

The Spektrum trademark is used with permission of Bachmann Industries, Inc.

Saito is a trademark of Saito Seisakusho Co. Ltd, Japan.

Aviat®, Aviat Aircraft™ and Eagle II™ are trademarks or registered trademarks of Aviat Aircraft, Inc.

All other trademarks, service marks and logos are the property of their respective owners.