

# ***Paladin Lite***

***PL18 Lite***

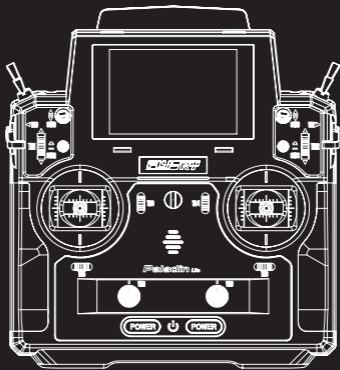

# Quick Start Guide

## **Precautions!**

For your own safety: make sure to download and read the Disclaimer & Warning documentation from the Flysky website before using this product.

Flysky Website : [www.flysky-cn.com](http://www.flysky-cn.com)

1. For best signal quality the transmitters antenna must be kept at least 20 cm away from all your body and must not be juxtaposed or operated close to other transmitters. Antenna installation instructions and transmitter operating conditions that meet RF signal emissions must be provided to end users and installers.
2. Hereby, [Flysky Technology co., Ltd] declares the RF equipment [Paladin lite PL18 lite] to be in accordance with RED2014/53/EU.
3. The full text of the EU DOC is available at: [www.flysky-cn.com](http://www.flysky-cn.com).

## Front View:

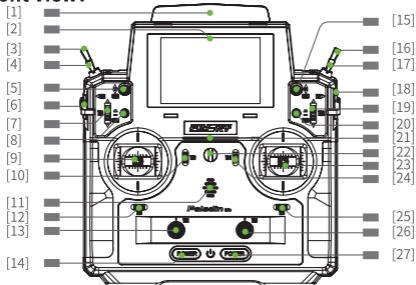

[1]	Antenna	[13]	VRA Knob
[2]	320×480 TFT LCD	[14]	Left Power Button
[3]	SWF- 2 Position Switch	[15]	SWD-3 Position Switch
[4]	SWE-3 Position Switch	[16]	SWH-2 Position Switch, Self-Resetting
[5]	SWB-3 Position Switch	[17]	SWG-2 Position Switch
[6]	VRD Lever/VRD Knob(A/B)	[18]	VRE Lever/VRE Knob(A/B)
[7]	TR1 Button	[19]	TR2 Button
[8]	SWA Button	[20]	SWC Button
[9]	Left Stick	[21]	Transmitter LED
[10]	TR3 Button	[22]	Lanyard Hook
[11]	Speaker	[23]	Right Stick
[12]	TR5 Button	[24]	TR4 Button

**Note:** PL18 Lite is divided into Version A and Version B. The VRD and VRE in Version A are levers. The VRD and VRE in Version B are knobs.

## 后视图:

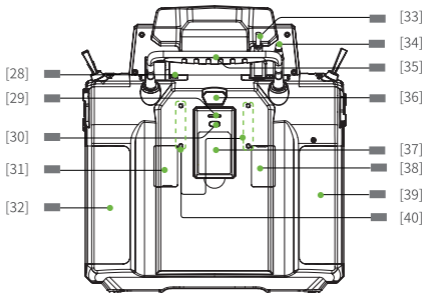

[25]	TR6 Button	[33]	Micro USB
[26]	VRB Knob	[34]	Coaching Port
[27]	Right Power Button	[35]	Handle
[28]	Bluetooth Port	[36]	FRM301 Press To Release FRM301 Module
[29]	FRM301 Status Indicator	[37]	FRM301 RF Module
[30]	FRM301 Button	[38]	Gimbal Stiffness Adjustment Screw
[31]	Gimbal Stiffness Adjustment Screw	[39]	Grip
[32]	Grip	[40]	Fixed hole of the RF module adapter

- For more information about the Paladin Lite transmitter please read the user manual.

## Power On

1. Check to make sure that the battery is fully charged;
2. Press both power buttons until the screen turns on.

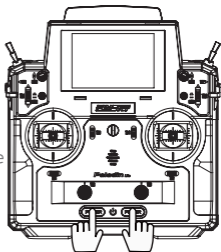

- !** If any switches are not at their highest positions, or the throttle is not at its lowest position, the system will prompt: “Switch is not in the highest position, throttle is not at the lowest position” . The transmitter will show which switches are not in the correct position by highlighting them in red on a diagram.

## Power Off

1. Power off the receiver.
2. Press and hold both power buttons until the screen turns off. After powering off the transmitter wait for 3 seconds before turning it on again.

- !** Always power off the receiver before the transmitter. Powering off the transmitter before the receiver may lead to loss of control of the model.

## Main Screen Introduction

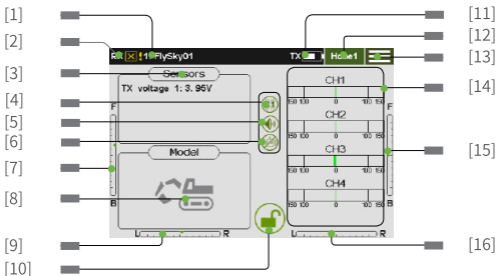

[1]	Model Name	[9]	TR5 Trim Value
[2]	Binding Indicate/ Signal Strength	[10]	Lock/Unlock
[3]	Sensor	[11]	Transmitter Power
[4]	Work Mode	[12]	Home Page
[5]	Vioce	[13]	Function Menu Icon
[6]	vibration	[14]	Channel Display
[7]	TR3 Trim Value	[15]	TR4 Trim Value
[8]	Model Type	[16]	TR6 Trim Value



Indicates that the screen is locked



Indicates that the screen is unlocked



Function Disabled



Function Enabled



Touch to restore functions default settings



Touch to enter function menu



Click to assign controls such as switches



Click to set the curve type

## Gimbal Adjustment Instructions

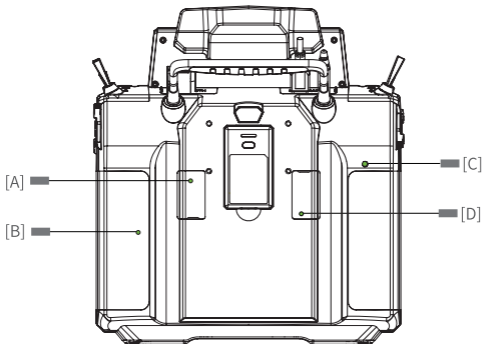

### Function Setup:

By adjusting the tension screws on the back of the radio, gimbal stick can be either self-centering or non self-centering.

### Available options:

A	Adjusting screw for self-centering/non self-centering of the right stick	B	Stick friction adjusting screw for non self-centering of the right stick
C	Stick friction adjusting screw for non self-centering of the left stick	D	Adjusting screw for self-centering/non self-centering of the left stick

## Left gimbal as example:

### Non Self-returning

1. Use a Phillips screwdriver to adjust the screw [A ] counterclockwise until the gimbal reaches its center point.
2. Adjust screw [B ]counterclockwise to adjust the Frictional strength.

### Self-return and Non self-return

1. Use a Phillips screwdriver to adjust the screw [A ]clockwise so that the gimbal is no longer at its center point.
2. Adjust the screw [B ]clockwise to strengthen or reduce the Frictional strength.



#### Attention

**After adjusting clockwise to the tightest, the counterclockwise adjustment range should be controlled below 5 turns. Over-adjustment will cause the screw to fall out.**



## Servo Frequency

This function is used to adjust the frequency of the channel output control servo, including analog servo (50 Hz), digital servo (380 Hz) and custom. The correct output frequency value can be selected or set according to the servo used. The system defaults to analog servo and the custom frequency adjustment range is between 50-400 Hz.



### Function Setup:

- Enter the main interface and touch 
- Enter [Rx Setup] and touch [Servo Frequency].
- Touch to select analog servo, digital servo or custom.
- If you select custom, touch "+" or "-" on the screen to adjust the frequency.





Check the servos user manual for the correct servo operating frequency. Using the wrong frequency may lead to issues and unpredictable movement.

## Language

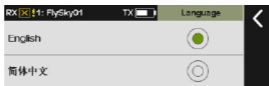
This transmitter has 2 languages available:



### Function Setup:

Touch the function menu icon  to enter the function menu, touch [System], then touch [Language]. Touch your preferred language option and touch the back icon  to save and exit.

## RF Module Update

If the following prompt is displayed on start up, the RF module needs to be updated.



Touch “yes” to enter update mode. Touch “no” to exit the update menu. If the RF module requires and update complete the following steps:

### How To Update:

Touch the function menu icon  to enter the function menu, touch [RF setup], then [RF firmware update]. When prompted touch yes to start the update. Once the update is completed the system will go back to the previous menu.

## Binding

The transmitter and receiver have been pre-bound at the factory, however if you need to bind a new receiver or rebind the original receiver follow the steps below.

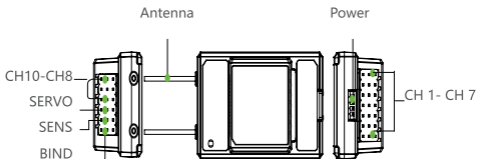

1. Connect the bind cable to the receivers bind port.
2. Connect power to any of the receivers other ports.
3. Turn on the transmitter, touch the function menu icon , touch [RX Setup], then [Bind with a receiver].
4. If binding has been successful the receivers status indicator will stop flashing and remain solid.
5. On the transmitter touch the back button to exit bind mode. Disconnect power then remove the bind cable from the receiver.
6. Power on the receiver again and check to make sure everything works as expected.



If after an update the transmitter is unable to connect or bind to the receiver, it is necessary to put the receiver into forced update mode, then go to the RX Setup menu and select RX update as normal.



Insert the bind cable as shown to short the pins and enter forced update mode.

The above steps are only applicable when pairing the Paladin Lite and FTr10. If you are using other receivers, please refer to the receivers user manual.

# Model Type





The transmitter includes a variety of options for modes, including fixed wing, glider, helicopter, multi-axis/quad and excavators.



**Attention**

**Before setting up, a model type must be selected.**

## Function Setup:

1. Touch the function menu icon  to enter the function menu, touch [Models], then touch [Set model type].  
The currently selected model will be highlighted in green.
2. To switch the model type, touch the corresponding model icon, and click [Yes] in the pop-up prompt box. The transmitter will then enter the structure settings for that model type.
3. Once the model is setup select the back icon  to save and exit.

## **Failsafe Function**

This function protects the user by preventing the model from behaving unexpectedly if signal is lost.

All 18 channels are displayed failsafe menu. If set to [OFF], the channel will remain at its last set position before losing signal.

If a percentage is displayed, then that channel will move to that percentage when signal is lost. Failsafe is active by default.

Failsafe Time: Sets how long it takes for the failsafe settings to kick in after signal loss.

### **Function Settings:**

Touch the function menu icon  to enter the function menu, touch [Rx Setup], touch [Failsafe]. Touch the icon at the bottom middle of the screen to turn failsafe on or off globally.

### **Failsafe Setup:**

Touch a channel to enter its failsafe menu. Move the stick, button, knob or switch to the desired failsafe position and touch the back button  to save and exit.

- When the  icon is displayed on a channel or in the global function bar the function is disabled for that channel or globally.
- The failsafe function needs to enter the [Auxiliary Channel] function to assign controls to aux channels before these channels can be used.

## Specifications

Paladin Lite (PL18 Lite)	
Product number	PL18 Lite
Channels	18
RF	2.4GHz
Transmission Power	< 20dBm (EU)
2.4GHz Protocol	AFHDS 3
Low Voltage Alarm	< 3.65V
Data Output	Micro USB
Charging Port	Micro USB
Antenna Type	Built-in Antenna
Input Power	1S (3.7V) *4300mAh
Online Update	Yes
Dimensions	196*214*86.5mm
Weight	895g(A) 881g(B)
Certification	CE, FCC ID: N4ZFT1800

## 注意事项！

开始操作前请务必在 Flysky 官网下载并阅读《免责声明 & 警告》了解安全注意事项，并在 Flysky 官网下载阅读使用说明书。

Flysky 官网地址：[www.flysky-cn.com](http://www.flysky-cn.com)

1. 发射机的天线必须距离所有人员或其他发射机至少 20 厘米的间隔距离。必须将天线安装说明和满足射频讯号辐射的发射机操作条件提供给终端用户和安装人员。
2. 特此,【Flysky Technology co., Ltd】声明无线电设备【Paladin Lite(PL18 Lite ),FT18 Lite】符合 RED2014/53/EU.
3. 欧盟 DOC 声明全文可在以下互联网地址:[www.flysky-cn.com](http://www.flysky-cn.com) 获取。



## 前视图:

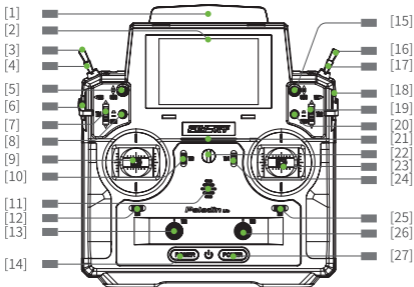

[1] 天线	[13] VRA 旋钮
[2] 320*480 显示屏	[14] 左电源键
[3] SWF 两档开关	[15] SWD 三档开关
[4] SWE 三档开关	[16] SWH 二档复位开关
[5] SWB 三档开关	[17] SWG 二档开关
[6] VRD 拨杆 /VRD 旋钮 (A/B)	[18] VRE 拨杆 /VRE 旋钮 (A/B)
[7] TR1 按键	[19] TR2 按键
[8] SWA 按键	[20] SWC 按键
[9] 左摇杆	[21] 发射机 LED 灯
[10] TR3 按键	[22] 吊环
[11] 喇叭	[23] 右摇杆
[12] TR5 按键	[24] TR4 按键

**注:** PL18 Lite 分为 A 版和 B 版, 其中 A 版 VRD 及 VRE 为拨杆, B 版 VRD 及 VRE 为旋钮。

## 后视图:

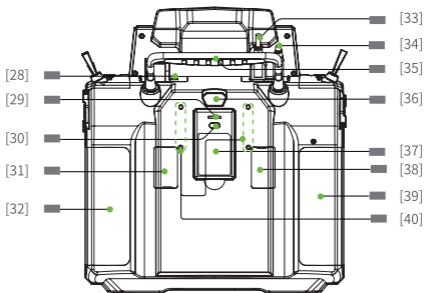

[25]	TR6 按键	[33]	Micro USB 接口
[26]	VRB 旋钮	[34]	教练孔
[27]	右电源键	[35]	提手
[28]	蓝牙模块插口	[36]	高频取出按键 (按压弹起 FRM301)
[29]	高频头 FRM301 指示灯	[37]	高频头模块 (FRM301)
[30]	高频头 FRM301 按键	[38]	总成座调节螺孔塞
[31]	总成座调节螺孔塞	[39]	手胶
[32]	手胶	[40]	高频转接件固定孔

- 关于 Paladin Lite 发射机的更多操作请阅读使用说明书。

## 开机

1. 检查系统状态，确保：  
电池电量充足；
2. 同时按住发射机两个电源键  
开机。

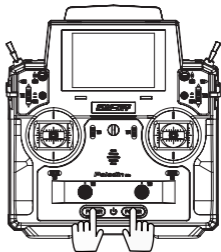

### 开机警告！

当开机语音提示“开关不在最高位，油门不在最低位”或“Switch is not in the highest position, throttle is not at the lowest

position”，同时发射机弹出提示界面时（红色表示对应控件位置需调整），请根据提示检查按键，开关，摇杆，并按照发射机提示将其放在正确位置。

## 关机

1. 断开接收机电源；
2. 同时长按发射机两个电源键，直至屏幕熄灭，表示关机。  
发射机屏幕熄灭后，需等待 3s 后，方可完全关闭，期间请勿再次开机。



关闭前，请务必先断开接收机电源，然后关闭发射机。如果强行关闭发射机，将有可能导致遥控设备失控或者引擎继续工作而引发事故。

# 主界面介绍

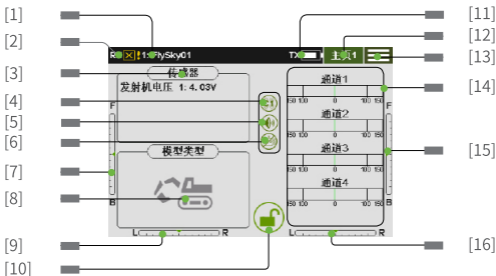

[1]	模型名称	[9]	TR5 微调值
[2]	对码提示 / 信号强弱	[10]	锁屏键
[3]	传感器	[11]	发射机电量
[4]	工作模式	[12]	主页栏
[5]	声音	[13]	点击可进入功能菜单
[6]	振动	[14]	通道显示
[7]	TR3 微调值	[15]	TR4 微调值
[8]	模型类型	[16]	TR6 微调值



表示功能或此界面被锁定不可操作



表示此功能在禁用状态



点击可使功能恢复初始值



点击可进行开关等控件分配



表示此功能或此界面可操作



表示此功能在开启状态



点击可对功能进行设置



点击可进行曲线类型设置

## 总成座调节说明

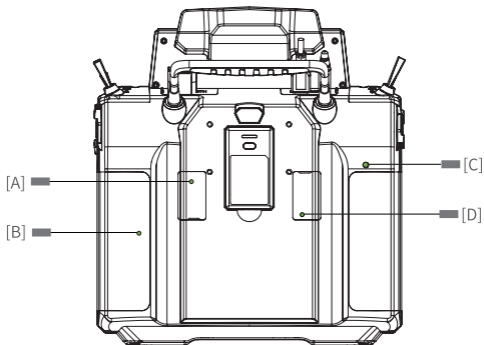

### 功能设置：

用户可调节螺丝孔螺丝实现总成座回中与不回中切换，请参照以下步骤：

### 螺丝说明：

A	右摇杆回中 / 不回中调节螺丝	B	右摇杆不回中时摇杆摩擦力调节螺丝
C	左摇杆不回中时摇杆摩擦力调节螺丝	D	左摇杆回中 / 不回中调节螺丝

**以右边摇杆为例：**

**不回中 - 回中：**

1. 请用十字螺丝刀逆时针调节 A 位置螺丝使摇杆变为回中状态；
2. 逆时针调节 B 位置螺丝调整摩擦力度；

**回中 - 不回中：**

1. 请用十字螺丝刀顺时针调节 A 位置螺丝使摇杆为不回中状态；
2. 顺时针调节 B 位置螺丝加强摩擦力度；



顺时针调到最紧后，逆时针调整范围应控制在 5 圈以下，过调会导致螺丝脱出。

## 舵机响应速度

此功能用于调节通道输出控制舵机频率，该功能包括模拟舵机（50Hz）、数字舵机（380Hz）、自定义频率，可根据使用的舵机选择或设置正确的输出频率值，系统默认数字舵机，自定义频率调节范围在 50-400Hz 之间。



功能设置：

- 进入主界面，点击 
- 进入【接收机设置】，点击【舵机响应速度】
- 点击选择模拟舵机、数字舵机或自定义频率
- 如选择自定义频率，请点击屏幕“+”、“-”进行频率调节



 为了使舵机正常运行，请先查阅舵机使用说明书确认舵机正确频率，然后通过该功能对舵机频率数值进行更改。

## 语言

本发射机可使用两种语言：



功能设置：

点击主界面  图标，进入功能菜单界面，选择进入 [ 系统设置 ] 功能，点击 [ 语言选择 ]，进入设置界面，可根据需要选择语言，设置完成后，点击返回 ，保存设置并退出。

## 高频模块固件升级

当开机时弹出如下提示，则需要更新高频模块。

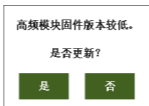

点击“是”，进入更新状态，点击“否”，退出更新界面，此时如需升级高频头，请参照以下步骤：

更新步骤：

点击主界面  图标，进入功能菜单界面，选择进入 [ 高频设置 ] 功能，点击 [ 高频模块固件升级 ]，在弹出提示后，点击 [ 是 ]，更新完成后，自动退出更新界面。



## 对码

本发射机和接收机在出厂前已对码成功。如果您需要对码时，请按照如下步骤进行对码：

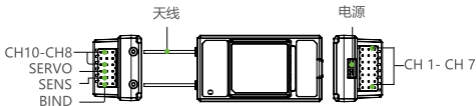

1. 将对码线连接至接收机 BIND 接口；
2. 将电源线连接至接收机其他任意接口，此时接收机快闪；
3. 开启发射机，点击主界面  图标进入功能菜单后，选择进入 [ 接收机设置 ]，点击 [ 接收机对码 ]；
4. 对码成功后，接收机指示变为常亮；
5. 点击退出发射机对码界面，将对码线断开；
6. 检查舵机是否正常工作。如需重新对码，请重复以上步骤。

**!** 发射机在更新完后，如无法与接收机对码，需强制更新接收机。在接收机进入强制更新模式后，在 [ 接收机设置 ] 功能中选择 [ 接收

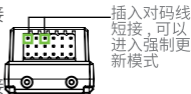

收机固件更新]，选择对应的接收机后点击 [ 升级 ]，即可完成更新。

以上步骤适用于 Paladin Lite 与 FTr10 的接收机对码，如您使用的是其他接收机，请进入官网查询。



## 模型类型



此发射机包含飞机模式、滑翔机模式、直升机模式、多轴、工程车等多种模型。

在设置各模型结构前，必须先选择正确的模型类型。

### 功能设置：

1. 点击主界面  图标，进入功能菜单界面，选择进入 [ 模型 ] 功能中 [ 设置模型类型 ]；  
绿色高亮状态的模型表示发射机当前模型类型。
2. 如需切换模型类型，点击对应模型图标，在弹出的提示框中点击 [ 是 ]，设置成功后将进入对应模型的结构设置界面。
3. 设置完成后点击此图标 ，即可退出。

## 失控保护

该功能用于在接收机丢失信号或失控后，保护模型和操作人员的安全。

失控保护菜单下显示 18 个通道的列表，如果在通道后显示 [ 关闭 ]，表示模型在丢失信号后，该通道的舵机会继续保持失控前的位置继续行驶。如果显示一个百分比，则表示模型在丢失信号后，该通道的舵机会移动到百分比对应的位置，并保持在该位置继续行驶。

触发时间：可设置失控生效的时间。

功能设置：

点击主界面  图标，进入功能菜单界面，选择进入 [ 接收机设置 ] 功能，点击 [ 失控保护 ]，进入设置界面，可根据需要进行失控保护的设置。

保护值设置方法：

点击选择所需设置通道，将通道对应控件（摇杆、按键、开关、滑杆）移动至所需位置保持不动，点击返回 ，保存设置并退出。

- 当对应通道界面显示  图标时，表示该功能处于关闭状态，设置无效。
- 失控保护功能需进入 [ 辅助通道 ] 功能为通道分配控件后，方可进行对应通道的失控保护设置。

## 规格参数

Paladin Lite (PL18 Lite)	
产品型号	PL18 Lite
通道个数	18
无线频率	2.4GHz
发射功率	< 20dBm (EU)
2.4GHz 模式	AFHDS 3
低电压报警	< 3.65 V
数据输出	Micro USB
充电接口	Micro USB
天线类型	内置天线
输入电源	1S (3.7V) *4300mAh
在线更新	Yes
外形尺寸	196*214*86.5mm
机身重量	895g (A 版) 881g (B 版)
认证	CE, FCC ID: N4ZFT1800



FCC ID: N4ZFT1800

出版日期 :2021-01-12

Copyright ©2021 Flysky Technology co., ltd

