



Perfect Appearance Excellent Performance

精 于 静 精 于 动

Sky Trainer 182

OPERATING MANUAL



Please visit both our Facebook fanpage and our homepage for updated product information

WARNING!

 **WARNING:** Read the ENTIRE instruction manual to become familiar with the features of the product before operating. Failure to operate the product correctly can result in damage to the product, personal property and cause serious injury.

This is a sophisticated hobby product and NOT a toy. It must be operated with caution and common sense and requires some basic mechanical ability. Failure to operate this Product in a safe and responsible manner could result in injury or damage to the product or other property. This product is not intended for use by children without direct adult supervision.

This manual contains instructions for safety, operation and maintenance. It is essential to read and follow all the instructions and warnings in this manual prior to assembly, setup, or use, in order to operate correctly and avoid damage or serious injury.

Safety Precautions and Warnings

As the user of this product, you are solely responsible for operating in a manner that does not endanger yourself and others or result in damage to the product or the property of others. This model is controlled by a radio signal subject to interference from many sources outside your control. This interference can cause momentary loss of control so it is advisable to always keep a safe distance in all directions around your model, as this margin will help avoid collisions or injury.

Age Recommendation: Not for children under 14 years. This is not a toy.

- Never operate your model with low transmitter batteries.
- Always operate your model in an open area away from cars, traffic or people.
- Avoid operating your model in the street where injury or damage can occur.
- Never operate the model in the street or in populated areas for any reason.
- Carefully follow the directions and warnings for this and any optional support equipment (chargers, rechargeable battery packs, etc.) you use.
- Keep all chemicals, small parts and anything electrical out of the reach of children.
- Moisture causes damage to electronics. Avoid water exposure to all equipment not specifically designed and protected for this purpose.
- Never lick or place any portion of your model in your mouth as it could cause serious injury or even death.



Table of contents

<i>Kit contents</i>	1
<i>The spare parts list</i>	1
Spare parts list content	
The illustration of the spare parts	
<i>Kit Inspection</i>	3
<i>Charging the Flight Battery</i>	3
<i>Low Voltage Cutoff</i>	6
<i>Assemble the plane</i>	6
Install the control horns	
Connect the linkage rod	
Connect the main wing halves	
Install the landing gear set	
How to install the Version 2 front landing gear set	
Install the fairing base of the stay bar	
Mount the main wing	
Install the stay bar	
Install the horizontal stabilizer	
Install the vertical fin	
The receiver chamber	
Install the battery	
Check the C.G. (Center of Gravity)	
<i>Get your model ready to fly</i>	17
Important ESC and plane information	
The transmitter and model setup	
Check the control throws	
Check the motor rotating direction	
Install the propeller set	
Install the antenna and the balancing fin	
<i>Before the model flying</i>	22
Find a suitable flying site	
Perform the range check of your plane	
Monitor your flight time	
<i>Flying course</i>	23
Take off	
Flying	
Landing	
Maintenance	
<i>Troubleshooting</i>	24
<i>AMA</i>	25

Kit contents



Kit contents

1. The fuselage assembly (With the motor, the canopy, the electronic parts, ESC)
2. Vertical stabilizer assembly
3. Horizontal stabilizer with the elevator
4. Landing gear set
5. Propeller and spinner
6. Spare parts bag
7. Wing tube and the stay bar

The spare parts list

Replacement parts for the FMS Sky trainer 182 are available using the order numbers in the Spare parts list that follows. The fastest, most economical service can be provided by your hobby dealer or mail-order company.

Spare parts list content

Spare parts list content

- MG 101 Fuselage (With all the plastic parts installed)
- MG 102 **Red/Blue/AT-Red/AT-Blue** Main wing set (With the control horn in stored)
- MG 103 **Red/Blue/AT-Red/AT-Blue** Vertical stabilizer
- MG 104 Horizontal stabilizer
- MG 105 Cowl
- MG 106 Spinner (With the back plate)
- MG 201 Motor (3536-KV850)
- MG 202 ESC (35A with 4A integrated BEC)

- MG 203 Battery (11.1V 2200mAh 25C)
 - MG 205 Servo (9g)
 - MG 206 LED set (Navigation light and the landing light)
 - MG 301-Red/blue/AT Red/AT Blue Landing gear set (The main and the front landing gear)
 - MG 302 Linkage rod (With the clevis and securing ring)
 - MG 303 Stay bar
 - MG 304 Screw set
 - MG 305-Red/Blue/AT Red/AT Blue Sticker
 - MG 306 Propeller (11*9 three blades durable propeller)
 - MG 307 Motor mount
 - MG 308 Firewall
 - MG 309 Wing tube
 - MG 310 Motor shaft
- Note:** The item# with the color mark means the parts are special for the different scheme.

The illustration of the spare parts



MG 101

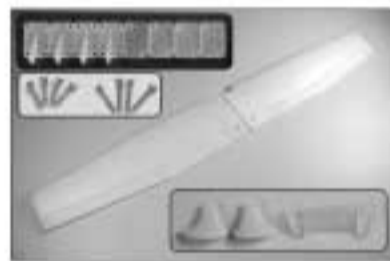

MG 102



MG 103



MG 104



MG 105



MG 106



MG 201



MG 202



MG 203



MG 205



MG 206



MG 301



MG 302



MG 303

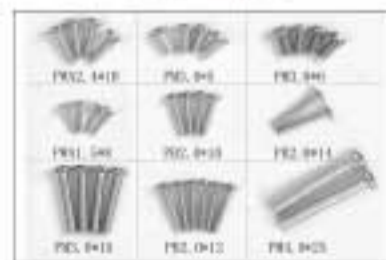

MG 304



MG 305



MG 306

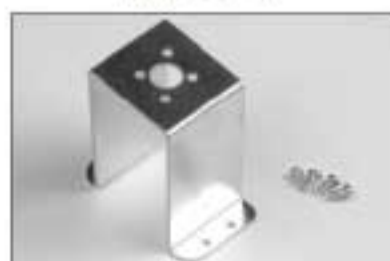

MG 307



MG 308

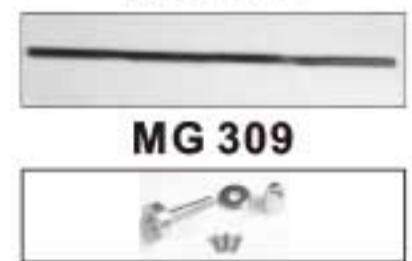

MG 309



MG 310

Kit inspection

Before starting to build, inspect the parts to make sure they are acceptable quality. If any parts are missing or are not in good shape or acceptable quality, or if you need assistance with setup and assembly, please feel free to contact FMSteam. Please write down the name of the parts when you are reporting defective or missing of them.

FMSteam Product Support

ADDRESS: 3/F, Building B, 3rd Industry Zone, Matigang, Dalingshan Town, Dongguan City, P.R.C

Ph: 0086-769-86976655

Charging the Flight Battery

The Battery Charger included with your aircraft is designed to safely charge the Li-Po battery, **Caution:** All instructions and warnings must be followed exactly. Mishandling of Li-Po batteries can result in fire, personal injury, or property damage.

Battery warning:

- ◆ By handling, charging or using the included Li-Po battery you assume all risks associated with lithium batteries.
- ◆ If at any time the batteries begin to swell, or balloon, discontinue use immediately! Charging or discharging a swelling or ballooning battery can result in fire.
- ◆ Always store the batteries at room temperature in a dry area to extend the life of the battery. Always transport or temporarily store the battery in a temperature range of 40-120°F. Do not store battery or model in a car or in direct sunlight. If stored in a hot car, the battery can be damaged or even catch fire.
- ◆ Never use a Ni-Mh charger. Failure to charge the battery with a compatible charger may cause fire resulting in personal injury and property damage.
- ◆ Never discharge Li-Po cells to below 3V.
- ◆ Never leave charging batteries unattended.
- ◆ Never charge damaged batteries.

Charging the flight battery

RTF kits come with a DC balancing charger. You must charge the battery with a Li-Po specific charger only (such as the included **BC-3S10** DC charger). When charging the battery, make certain the battery is on a heat-resistant surface, charge the battery before assembly of the airplane. Install the fully charged battery to perform control tests and binding.

BC-3S10 Balance Charger

To correctly use the charger, please read the instructions before use.

Charging the Flight Battery

Electrical Parameters

Parameter	Min	Type	Max	Unit
Working Voltage				V
Input Power				W
Work Temperature				°C
Store Temperature				°C
Charging Stop Voltage				V
Charging Current				mA
Balancing Current				mA
Activate Current				mA

Charging the Flight Battery

Using Steps:

1. Connect the charger to adapter with enough voltage and wattage, then the Power LED will turn on;
2. Connect 2S/3S battery pack to the corresponding balance port (**Do not connect two battery packs at the same time**), then the Charge LED will flicker (1Hz) and start charging.
3. When the Charge LED stops flickering, charging is complete, and the batteries can be unplugged.

Charging Function Description

1. If all voltage of the installed battery pack is higher than 4.18V, charging will not start and the charge LED will shine.
2. If the voltage of one battery or some batteries is lower than 0.7V, charging will not start. If the voltage of the first battery of a 3S battery pack is lower than 0.7V, the charger will charge the battery pack as if it was a 2S battery pack.
3. If the voltage of one battery or some batteries is lower than 2.8V, the charger will activate the battery pack with a small current. If the voltage can't be increased above 2.8V after half an hour, the charger will judge the battery pack as bad. The charge LED will then flicker rapidly (0.5Hz), and charging will stop.

Self Checking Function

1. Charger will perform a self test before each charge. The charge LED will rapidly flicker (0.5Hz) if the charging function is abnormal;
2. Accuracy checking Function: Connect a fully charged 3S battery pack (all voltage at least 4.2V), the charge LED will flicker twice then shine always. This means that the accuracy is normal.

Protection Function

1. Reverse connection protection of input
2. Reverse connection protection of output
3. Short circuit protection of output
4. Over voltage protection of output

Troubleshooting

1. **Power LED does not shine** – Adapter isn't connected correctly. Please check the polarity and reconnect adapter.
2. **Charging abruptly stops and tries to restart constantly during charging** – Output power of the adapter is not sufficient, please replace the adapter.
3. **Charge LED does not shine** – Reconnect the battery pack; Check the voltage of batteries.
4. **Charge LED rapidly flickers** – Battery is bad or charging function is abnormal. Replace battery or contact technical support.

Low voltage cut off (LVC)

When a Li-Po is discharged below 3V per cell, it will not hold a charge. The ESC protects the flight battery from over-discharge using Low Voltage Cutoff. Before the battery charge decreases too much, LVC removes power from motor in two ways: (1) Reduces power - ESC reduces motor power (recommended), (2) Hard cutoff - ESC instantly cuts motor power when the pre-set Low Voltage Protection Threshold value is reached. These settings can be changed using the ESC programming guide (available on-line).

Assemble the plane

Install the control horns

1. The control surface horns for the elevator and rudder are stapled to the bags containing the elevator and the rudder respectively.
3. Implement the control horn backplate into the other side of the surface with the small mounting nose protrude into the foam.



2. Install the elevator control horn on the down side (with the mounting nose) of the surface with the horn toward the right direction.



3. Implement the control horn backplate into the other side of the surface with the small mounting nose protrude into the foam.

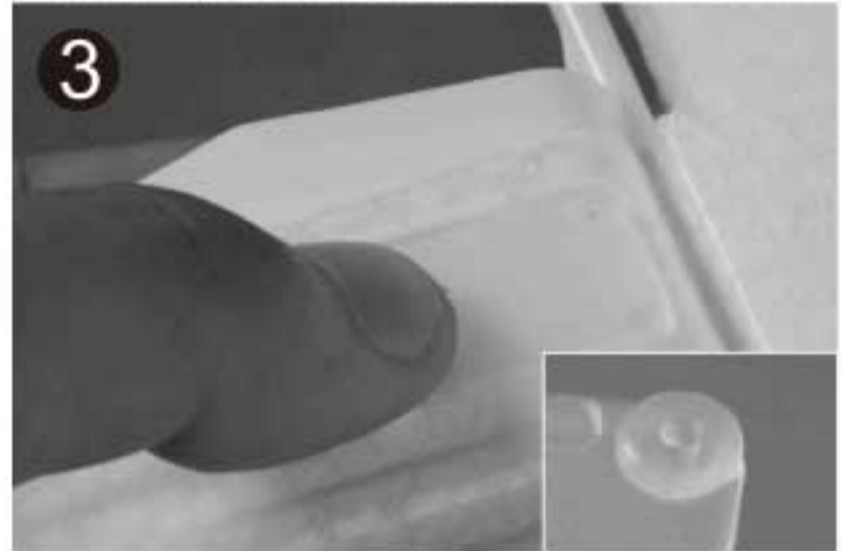

4. Secure the horn using the provided screws from the horn side.

Note: The longer screws for secure the horns always located on the leading side of the surface.

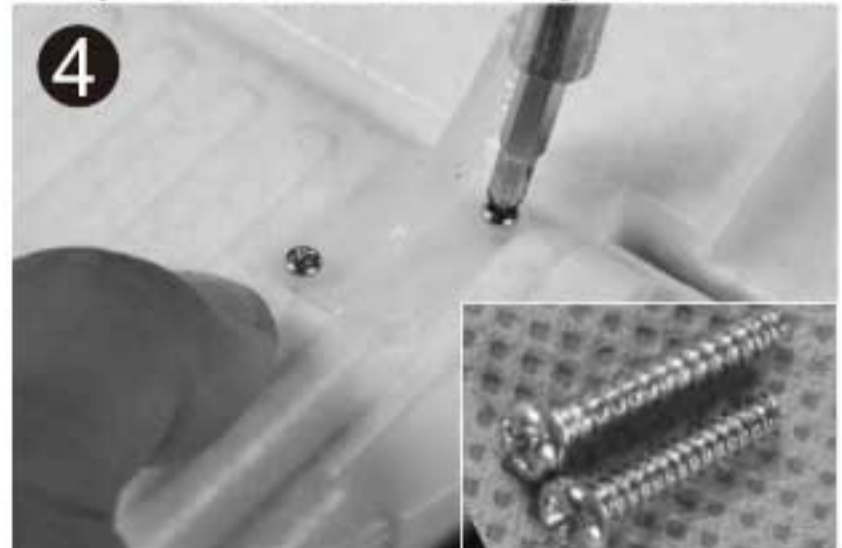

Assemble the plane

5. Make sure the screws firmly grabbed into the backplate.

Note: Do not over tighten the screws, but make sure they are tight enough.

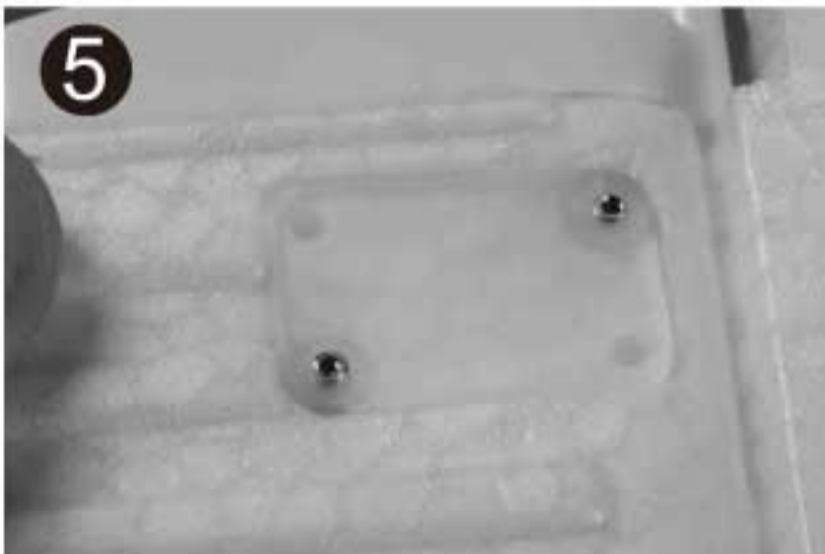

6. Attach the rudder control horn on the port (left) side of the rudder.



7. The spare parts bags for the aileron and flap are labeled for easy to use.



8. Install the control horn of the ailerons and the flaps the same, make sure the horn toward the hinge line of the control surface.



Connect the linkage rod

1. Put the Z-bend end of the linkage into the desired servo control horn hole. It is a tight fit and should allow the linkage to move just slightly within the hole to avoid binding up.



2. Snap the clevis into the surface control horn.



Assemble the plane

- The provided piece of fuel tubing keeps the clevis closed during flight. Secure all the linkages the same way.

Note: Do not over slide the securing



- Seal the servo and Led leads from the wing panel in the notch using the tape.

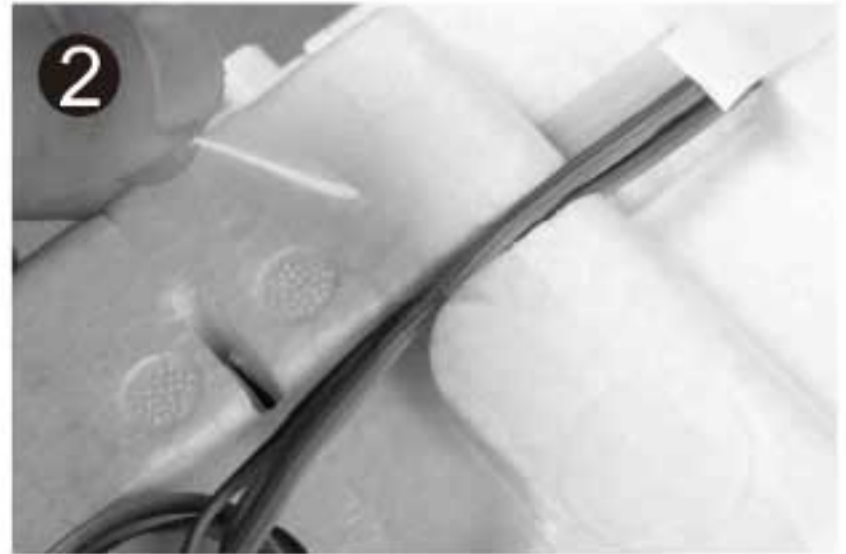

Connect the main wing halves

- Slide the connector tube into the socket till the half of it, do not force it further than it will slide, this will push the wing tube into the foam in the wing, and possibly prevent it from insert fully into the opposite wing panel.



- Tie the leads from the wing panel together using the in stored securing tape, remove the redundant end of the tape for the decreased chance of binding.

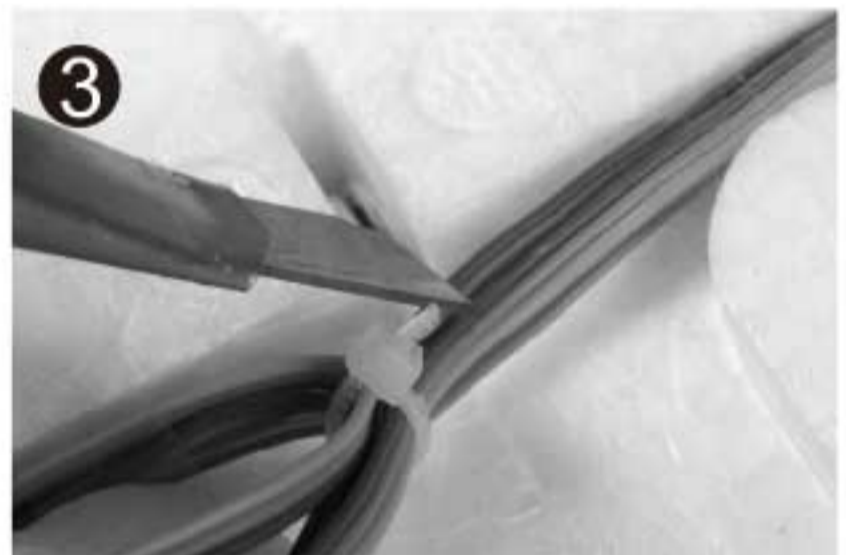

- Connect the 3 LED leads from the wing panel with the three way harness, the spare end for the tail fin LED.

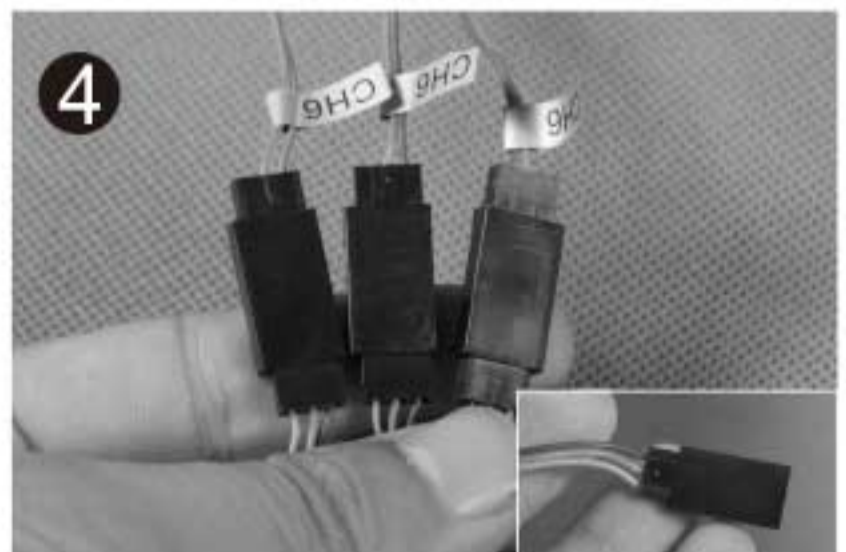

Assemble the plane

5. Plug the aileron and flap servo leads to the Y-harness with the channel labeled rightly. Secure the connector using the tape.

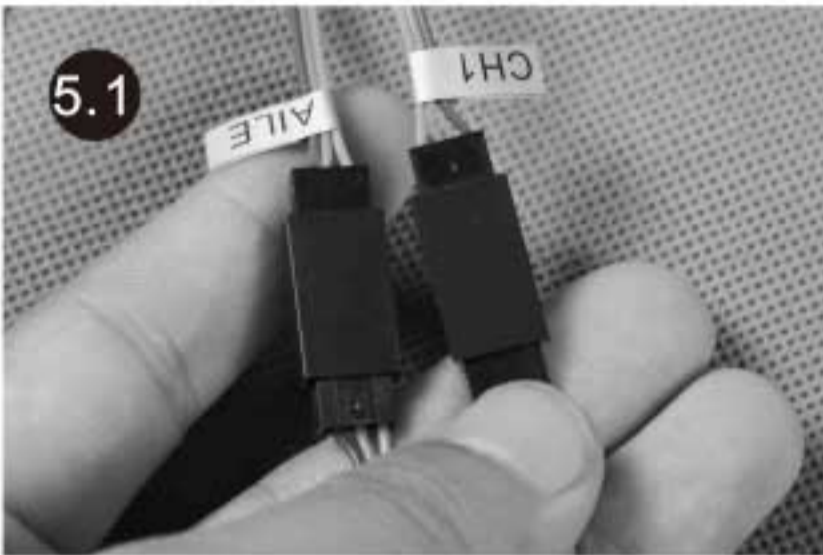

Install the landing gear set

1. Install the main landing gear by fitting the gear into the fuselage fully as the picture shows.

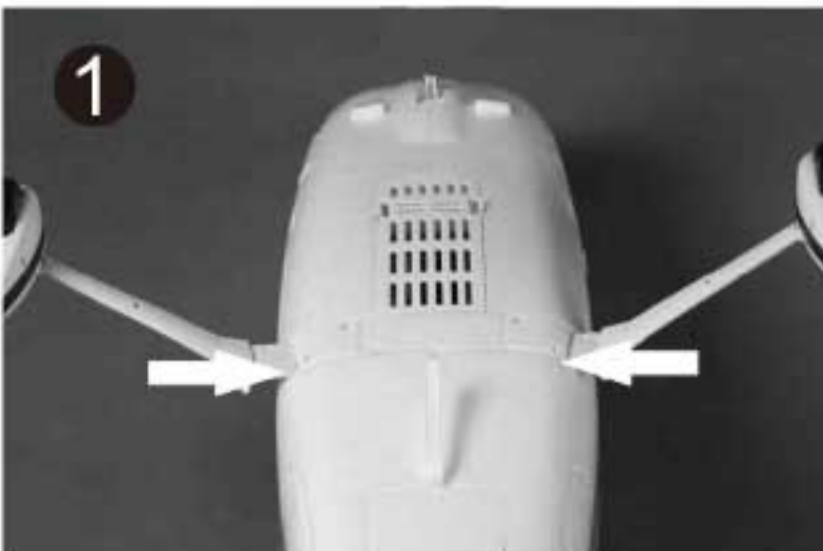

2. Secure the main landing gear using the four pieces of machine screws.
(Screws: PM 3.0*16 4PCS)

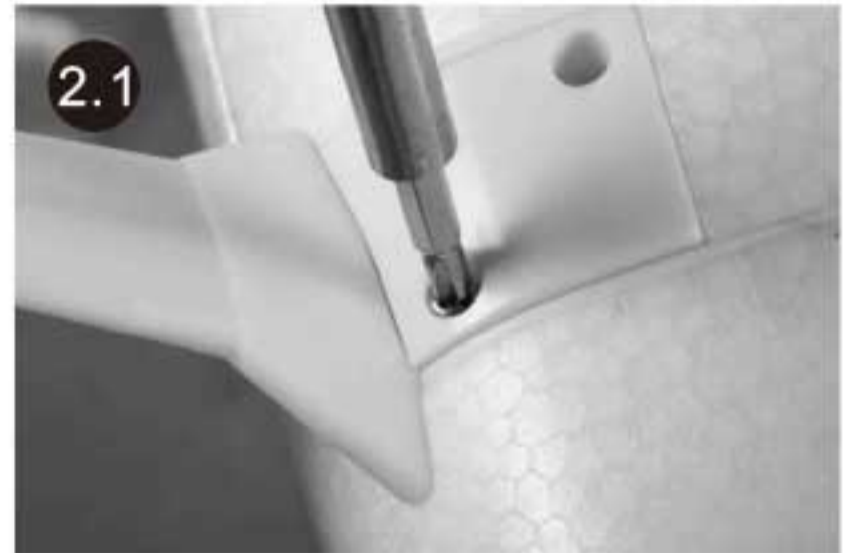

How to install the Version 2 front landing gear set

1. The new V2 front landing gear is much stronger than before, it is even with the shock absorption for better landing.

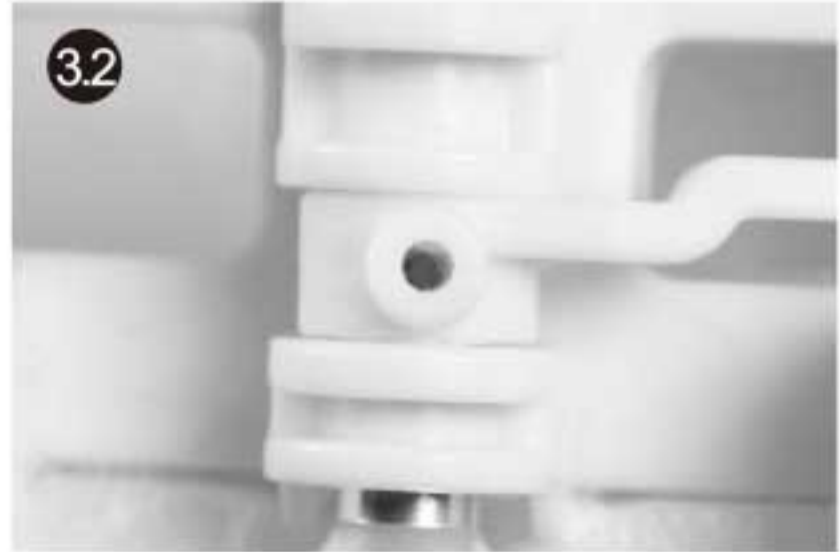

2. remove the cowling and turn over the fuselage so the bottom faces up. Make sure the hinge control hole and the front strut hole of motor board are 100% matched.

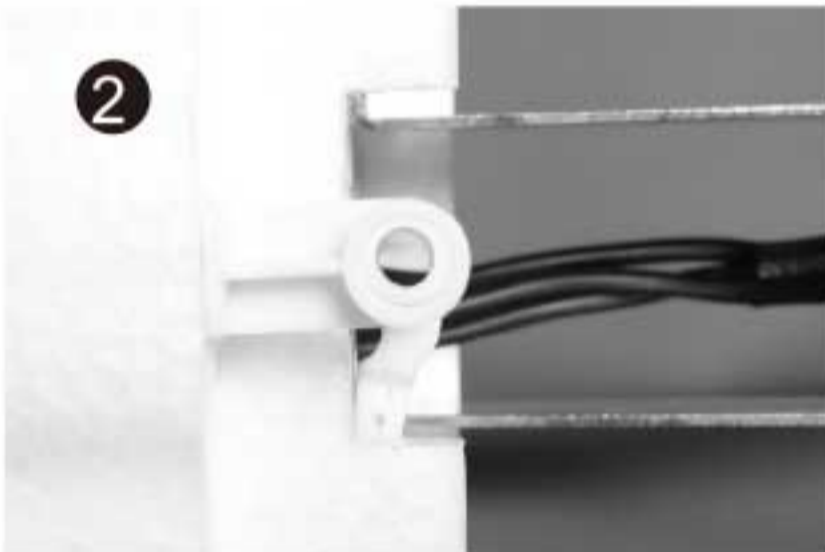

4. When two holes are 100% matched, secure to hole using the screw. Make sure do not over tighten the screw but it is tight enough.



3. Remove the screw on the control horn and install the front landing gear as photo shows. Make sure the front landing gear hole and the control horn hole are 100% matched.



5. Install the Cowling properly.



Assemble the plane

Install the fairing base of the stay bar

1. Take the base out from the spare parts bag, the left one with the antenna is for the main wing, the right one is for the fuselage



2. Fit one of the fairing to the main wing, it will fit perfectly into the notch with it inclined to the wing roots side.

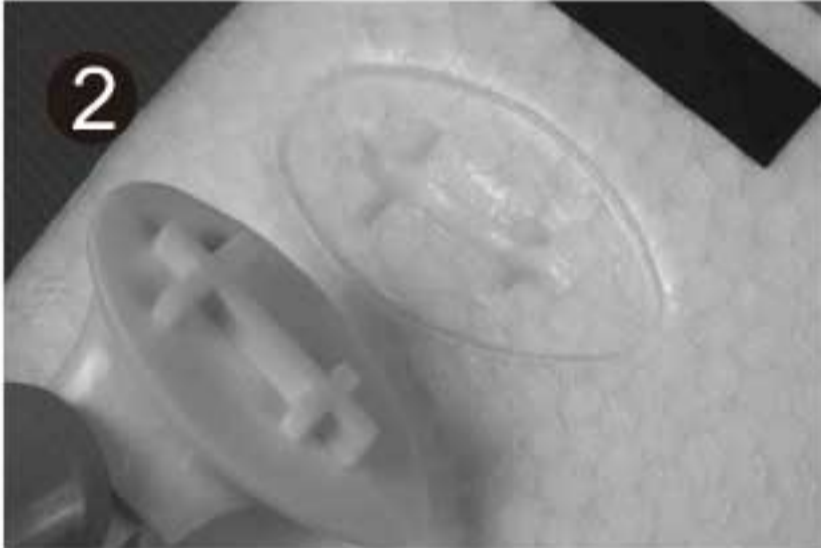

3. Apply glue to the fairing base where it fits with the main wing, we recommended the glue to be applied on both the main wing and the base. Then glue it into place.



4. Install the fairing base of the fuselage the same with the main wing one, make sure the base will incline the topside of the fuselage.

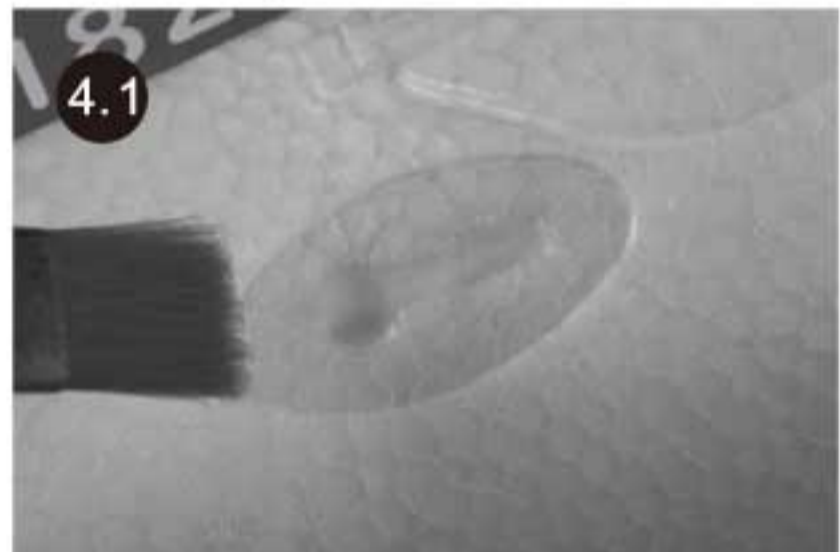

Mount the main wing

1. Thread the wire leads from the main wing into the rectangular hole at the back of the cockpit hatch.



2. Slide the main wing forward make sure the dowel at the front of the main wing keyed into the hole for the main wing mounting. Be sure to pull the wire leads from the battery hatch the same time to avoid any tangling to prevent the main wing from fully installation.

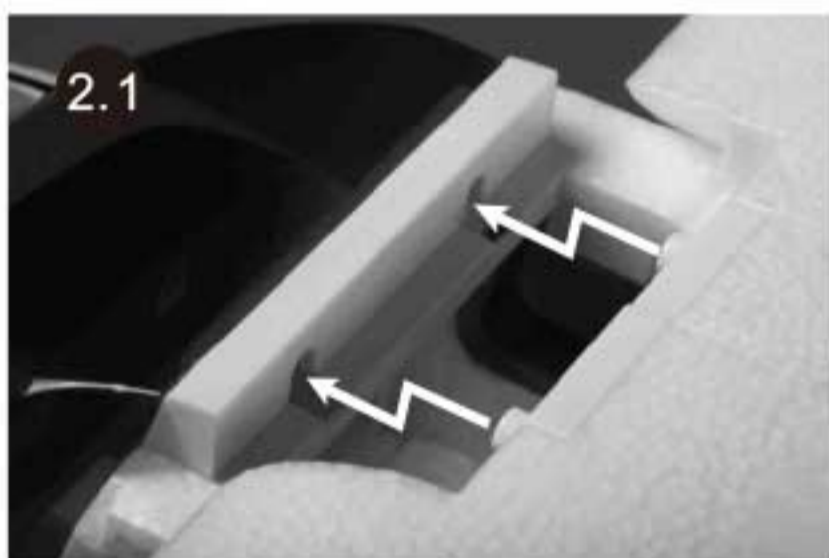

3. Fully keyed the dowels into place and secure the main wing using two pieces machine screw.
(Screws: PM4.0*25 2PCS)



Assemble the plane

Installing the stay bar

1. Fit the nuts into the hex hole at both end of the stay bar, hold it into place while you secure it using the in stored screw, the stay bar will mate perfectly with the fairing base.

Note: Use a drop of Loctite on the nuts side, but make sure no Loctite are allowed to contact with the plastic bar or it will erode the bar.

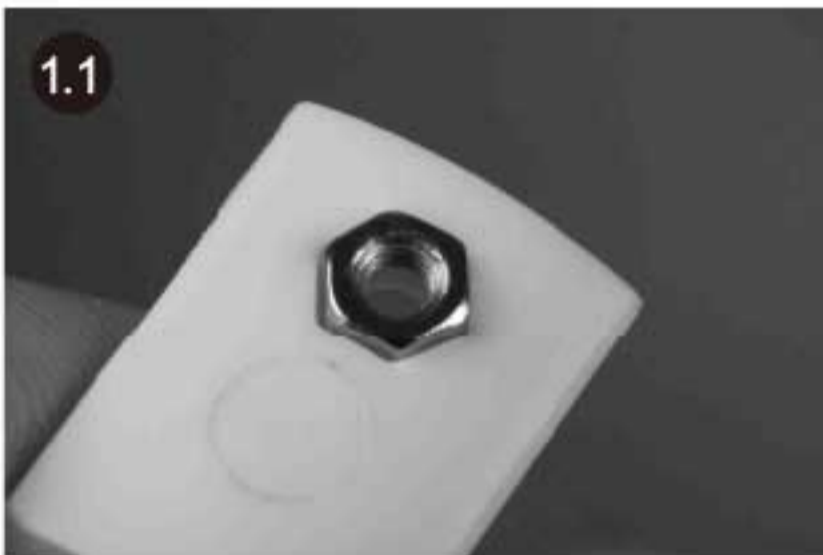

Install the horizontal stabilizer

1. Apply glue to the horizontal stabilizer where it mating with the fuselage tail.

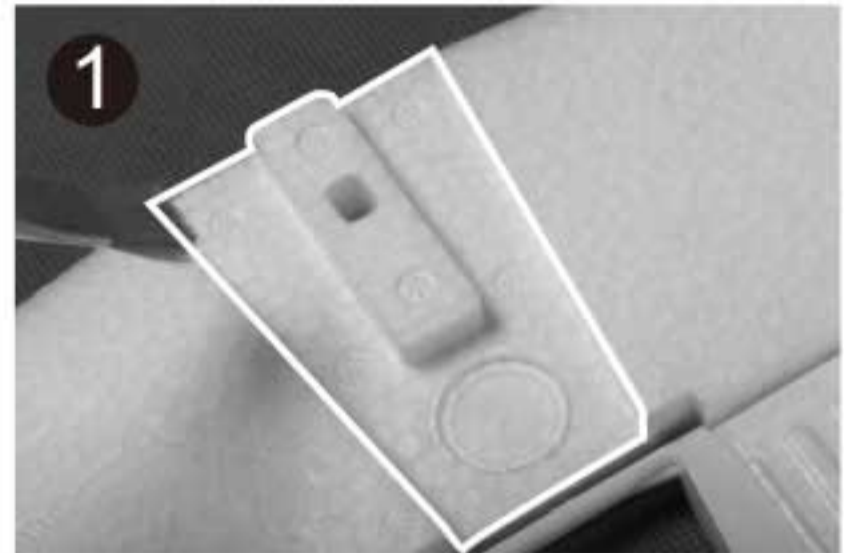

2. Thread the lead of the extensive wire for the tail LED from the bottom of the stabilizer to the upside before fully seat it into place.

Note: Make sure the lead can move freely from the fuselage and the horizontal tail assembly.

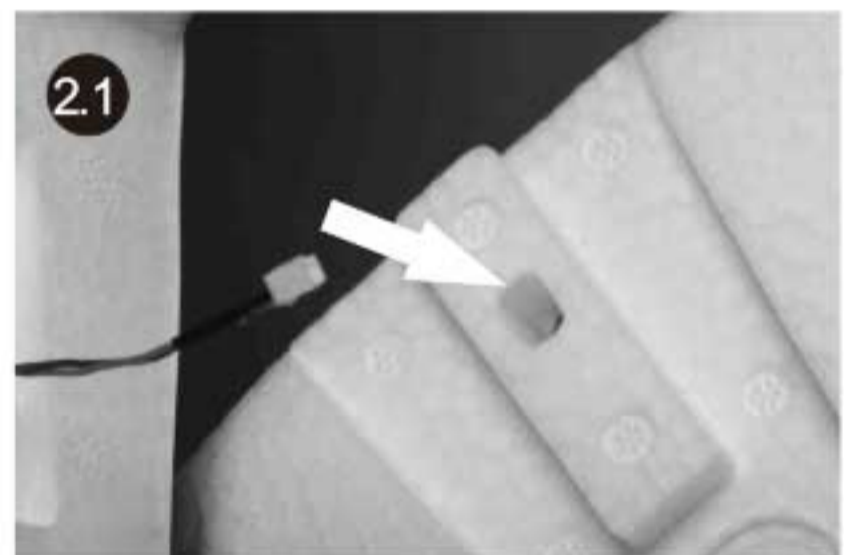

Install the vertical fin

1. Apply glue to the vertical stabilizer where it mating with the fuselage tail and the horizontal stabilizer using a glue brush.

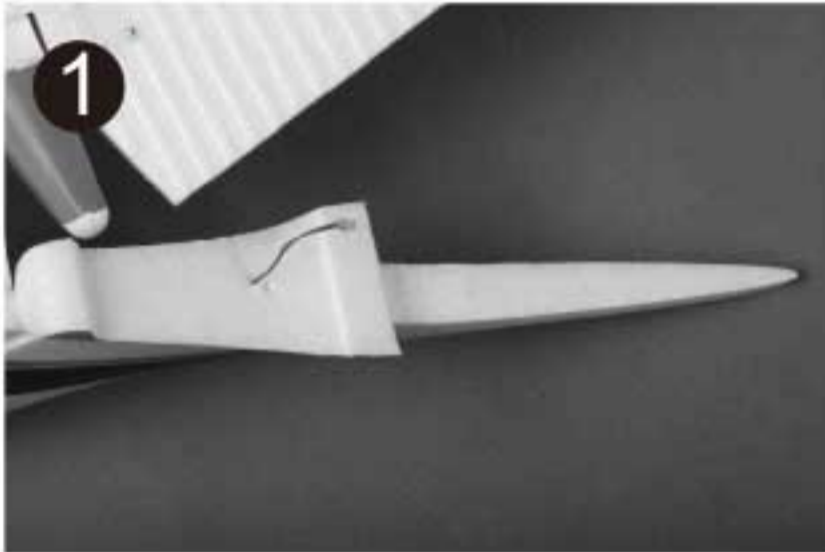

2. Connect the tail LED to the extensive wire and make sure to mate the polarity right. Use the tape to secure the connector.



3. Pull the extensive wire while slide the fin into place, check if the connector is fully seated into the hole on the horizontal fin.



4. Fully seat the stabilizer into place, make sure there is no gap left between the stabilizer and the fuselage. Make sure the vertical stabilizer is perpendicular to the wing as shown. Adjust any misalignment before the glue dries throughly.



The receiver chamber

1. Connect the tail LED extensive wire with the spare lead from the Y harness in the servo chamber (The lead mentioned in the Connect the main wing halves **step 4**).

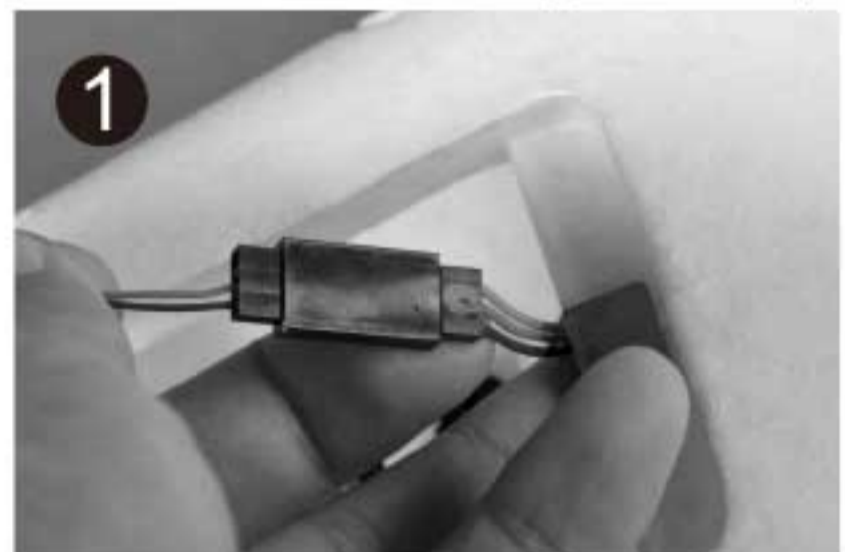

Assemble the plane

2. Attach aileron servo to the Aileron channel of your receiver. Elevator harness goes to elevator channel of your receiver. Steering servo goes to the Rudder channel. Attach the ESC connector to the throttle channel of the receiver. The LED to any spare channel.



2.2		Receiver
Aileron	1	Channel-1 — Aile
Elevator	2	Channel-2 — Elev
Throttle	3	Channel-3 — Thro
Steering	4	Channel-4 — Rudd
Flap	5	Channel-5 — Flap
LED	4	Spare Channel

3. Tuck the wire leads into the recessed cavity at the rear end of the battery hatch.

Note: Seat the receiver into the aside chamber as the picture shows.



Install the battery

1. Apply the hook tape to the cable end of the battery.

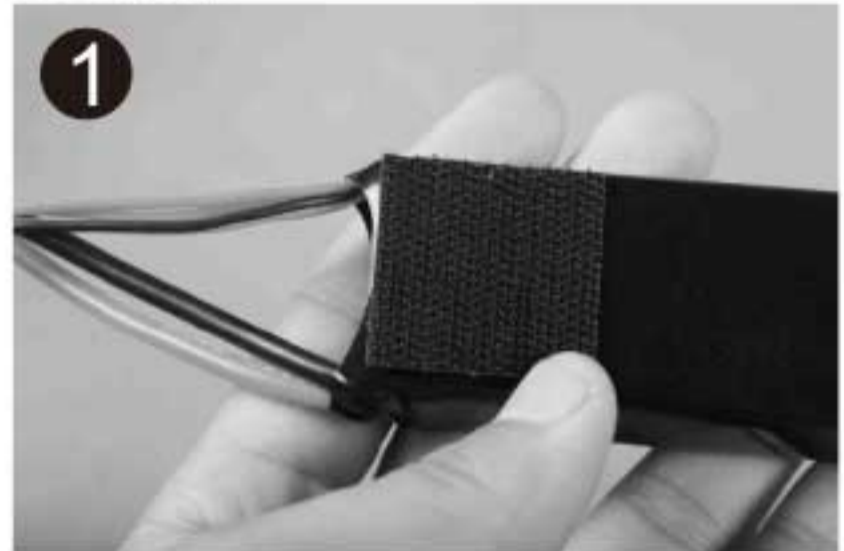

2. Slide the battery into the battery hatch with the power supply cable toward the rear end of the plane and the hook tape face the bottom of the battery hatch.
Note: You may need to relocate the battery position to achieve the correct CG for your Sky trainer 182 model.



Check the C.G. (Center of Gravity)

Center of Gravity

When balancing your model, adjust the motor battery as necessary so the model is level or slightly nose down. This is the correct balance point for your model. After the first flights, the **CG** position can be adjusted for your personal preference.

1. The recommended Center of Gravity (**CG**) location for your model is (**60mm**) forward from the leading edge of the main wing (as shown) with the battery pack installed. Mark the location of the **CG** on top of the wing.
2. When balancing your model, support the plane at the marks made on the bottom of the main wing with your fingers or a commercially available balancing stand. This is the correct balance point for your model. Make sure the model is assembled and ready for flight before balancing.

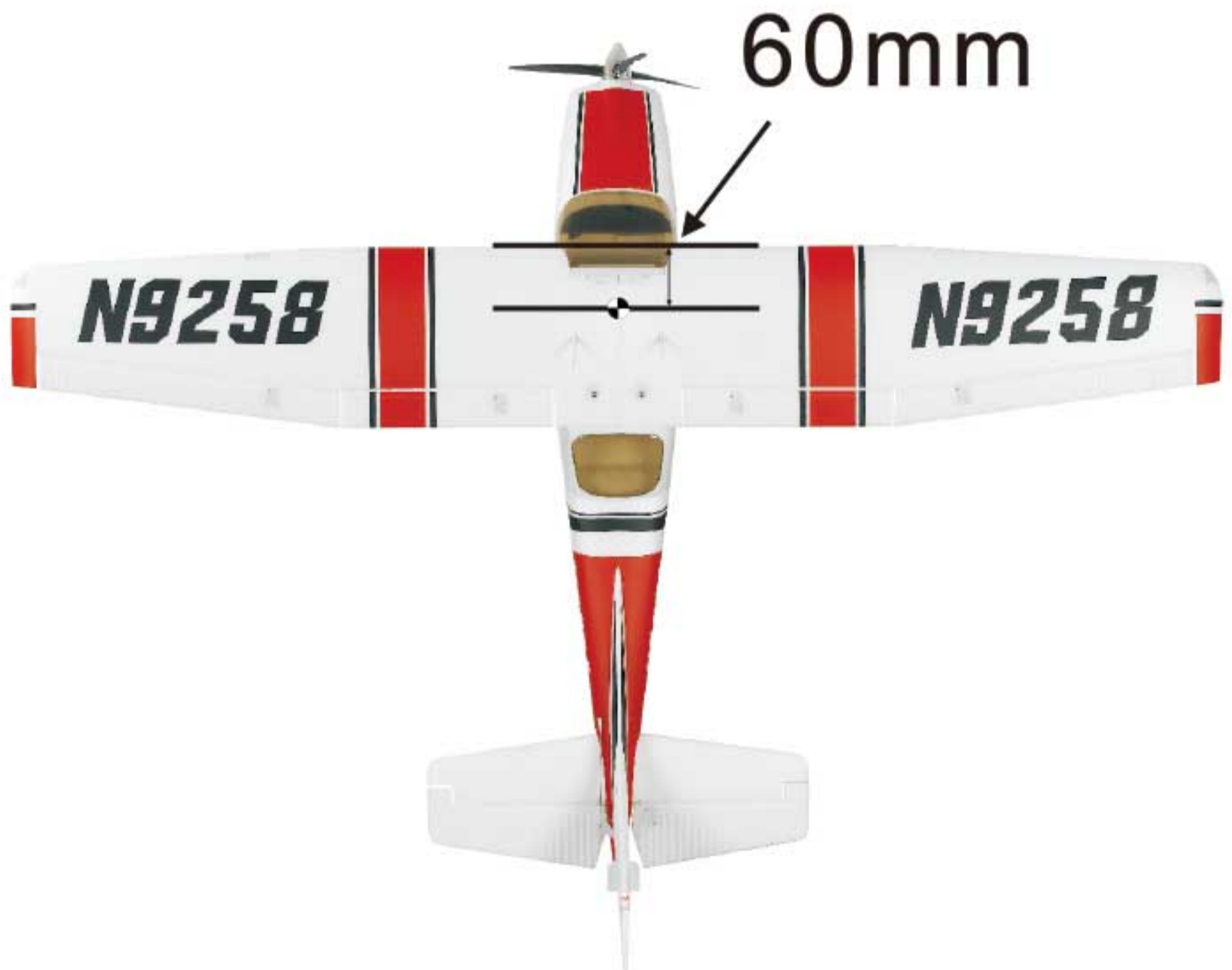

Get your model ready to fly

Important ESC and model information

1. The ESC included with the sky trainer has a safe start. If the motor battery is connected to the ESC and the throttle stick is not in the low throttle or off position, the motor will not start until the throttle stick is moved to the low throttle or off position. Once the throttle stick is moved to the low throttle or off position, the motor will emit a series of beeps. Several beeps with the same tune means the ESC has detected the cells of the battery. The count of the beeps equals the cells of the battery. The motor is now armed and will start when the throttle is moved.
2. The motor and ESC come pre-connected and the motor rotation should be correct. If for any reason the motor is rotating in the wrong direction, simply reverse two of the three motor wires to change the direction of rotation.
3. The motor has an optional brake setting. The ESC comes with the brake switched off and we recommend that the sky trainer be flown with the brake off. However, the brake could be accidentally switched on if the motor battery is connected to the ESC while the throttle stick is set at full throttle. To switch the brake off, move the throttle stick to full throttle and plug in the motor battery. The motor will beep one time. Move the throttle stick to low throttle or the off position. The motor is ready to run and the brake will be switched off.
4. **Battery Selection and Installation.** We recommend the 11.1V 2200mAh 25C Li-Po battery. If using another battery, the battery must be at least a 11.1V 2200mAh 25C battery. Your battery should be approximately the same capacity, dimension and weight as the 11.1V 2200mAh 25C Li-Po battery to fit in the fuselage without changing the center of gravity significantly.
5. The specification of the model is as follows:

Wingspan	: 1410mm/55.5in
Length	: 1100mm/43.3in
Weight	: 1520/53.6oz
Wing Area	: 27.0dm ²
Wing Load	: 56.3g/dm ²
The TX requires	: 5 Channel













The transmitter and model setup

Before getting started, bind your receiver with your transmitter. Please refer to your **Transmitter Manual** for proper operation.

CAUTION: To prevent personal injury, DO NOT install the propeller assembly onto the motor shaft while testing the control surfaces. DO NOT arm the ESC and do not turn on the transmitter until the **Transmitter Manual** instructs you to do so.

Tips: Make sure all control sticks on your radio are in the neutral position (rudder, elevator, ailerons) and the throttle in the OFF position. Make sure both ailerons move up and down (travel) the same amount. This model tracks well when the left and right ailerons travel the same amount in response to the control stick.

1. Move the controls on the transmitter to make sure aircraft control surface move correctly. See diagrams below.

	Bank Left		Aileron
	Bank Right		
	Climb		Elevator
	Descend		
	Steer Left		Steering Rudder
	Steer Right		

Get your model ready to fly

2. Make sure all servo arms are fully vertical. If not, adjust the servo arm by using the trim function on your radio. **Note:** For computerized transmitters, use the servo/channel sub-trim feature to make each servo arm fully vertical.
3. The standard hole settings for linkage connections are shown by the black arrows in the diagram below. You can move the linkage to different hole positions to increase control surface travel and increase the aerobatics of the airplane.

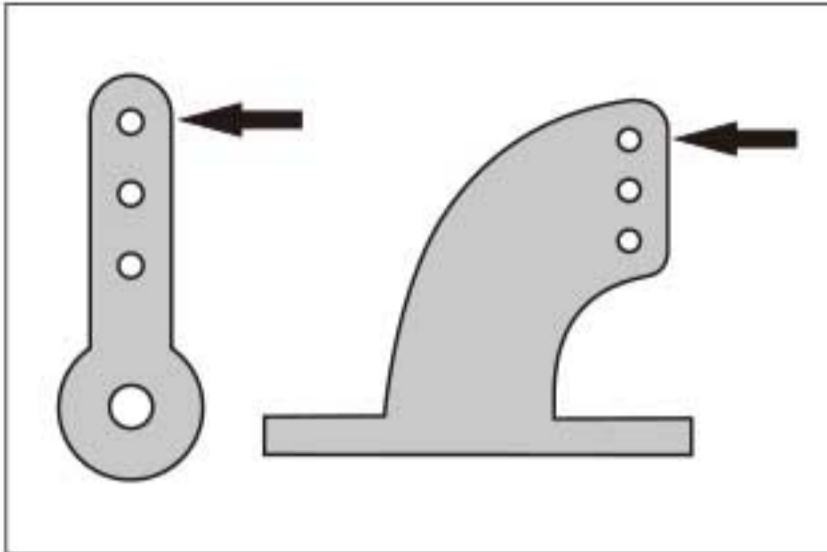

4. Align the control surface with the wing root by turning the clevis clockwise and counterclockwise on the linkage, carefully open the clevis fork and put the clevis pin in the desired hole of the control horn.
Note: Please secure the clevis with provided piece of tube after the alignment of the surface is completed.

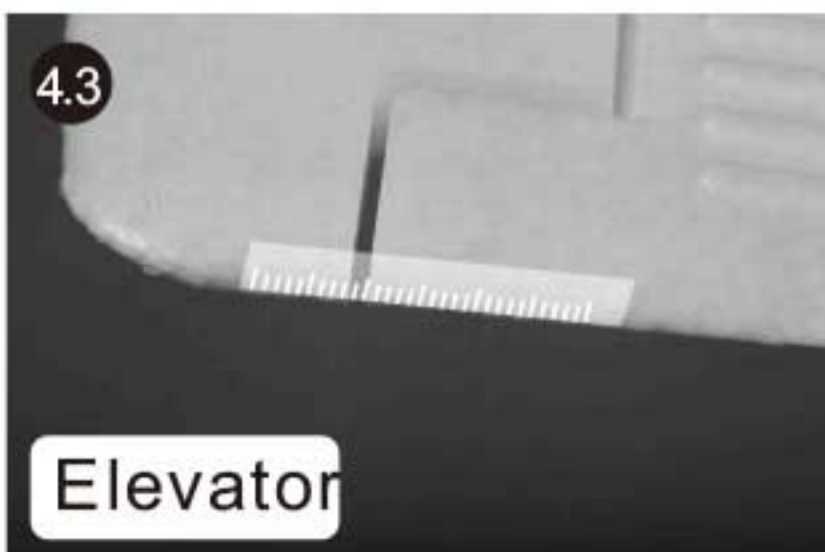
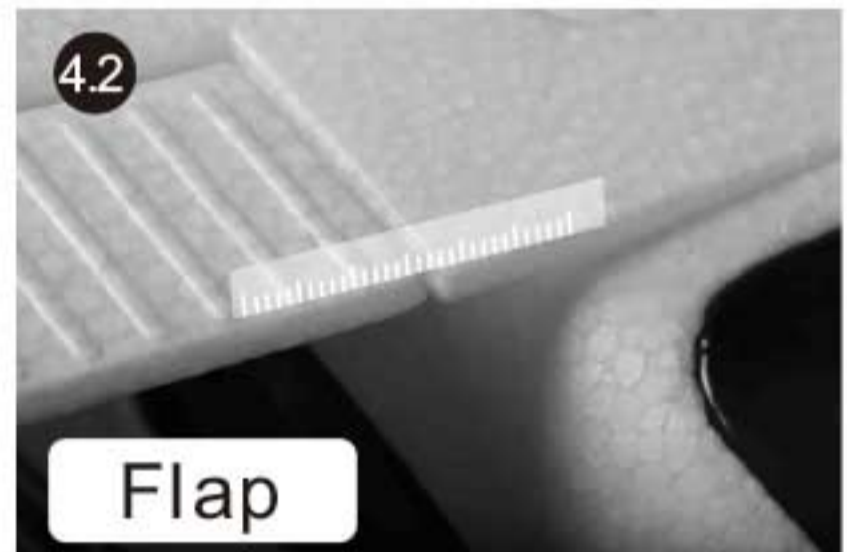
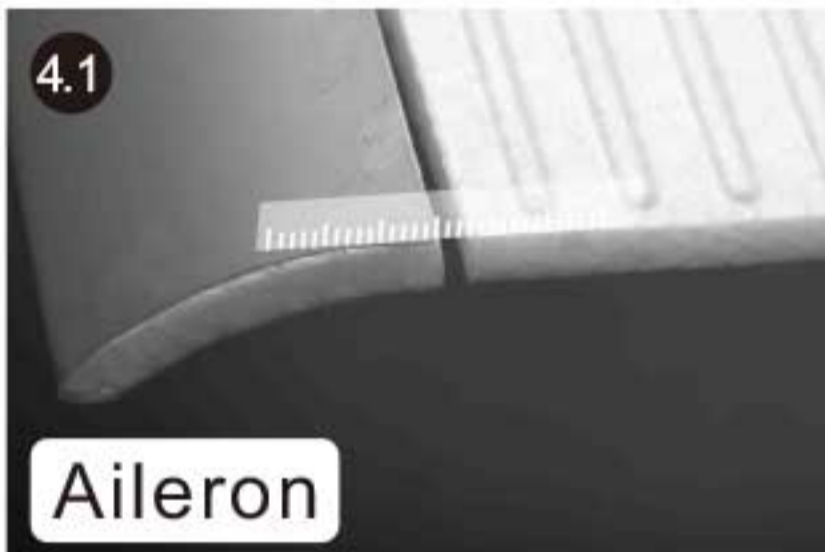

Get your model ready to fly

Check the control throws

The suggested control throw settings for **FMS MODEL** are as follows (Dual rate setting):

	High Rate	Low Rate
Elevator	15mm up/down	10mm up/down
Aileron	18mm up/down	12mm up/down
Rudder	12mm left/right	8mm left/right
Flaps full down:	15mm	

Tips: At first flight, fly the model in low rate. The first time you use high rates, be sure to fly at low to medium speeds. High rates, as listed, are only for EXTREME maneuvering.

Check the motor rotating direction

1. The motor should rotate clockwise when viewing the plane from the rear.



Install the propeller set

1. Keyed the spinner back plate onto the motor shaft fully. The plate will mate with the hex nut on the shaft.



2. Install the propeller set to the motor shaft, the side with the propeller pitches and measurement faces the front of the plane.



3. Make sure the propeller blades root ride properly on the propeller position saddle.

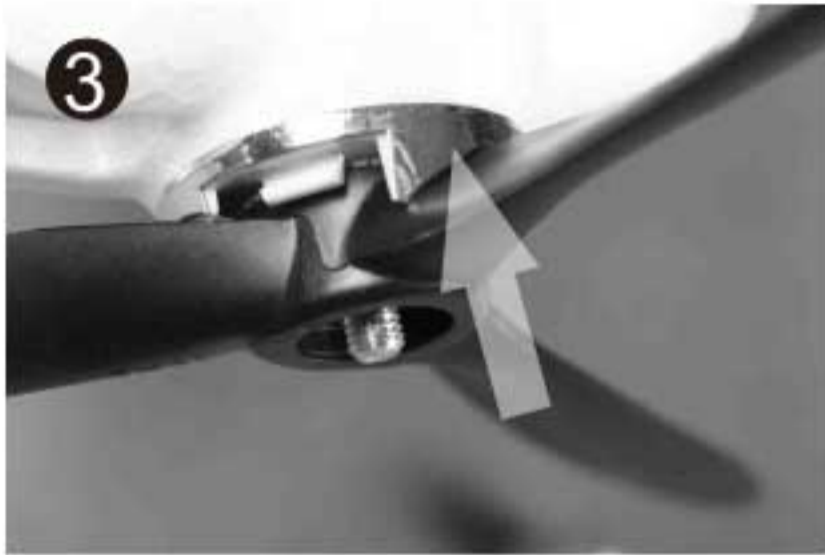

4. Secure the propeller using the nut and make sure it's tight enough.



5. Snap in the spinner, make sure it is fully seated into place.



Install the antenna and the balancing fin

1. Glue the antenna masts and the tail balancing fin into place as the pictures show.

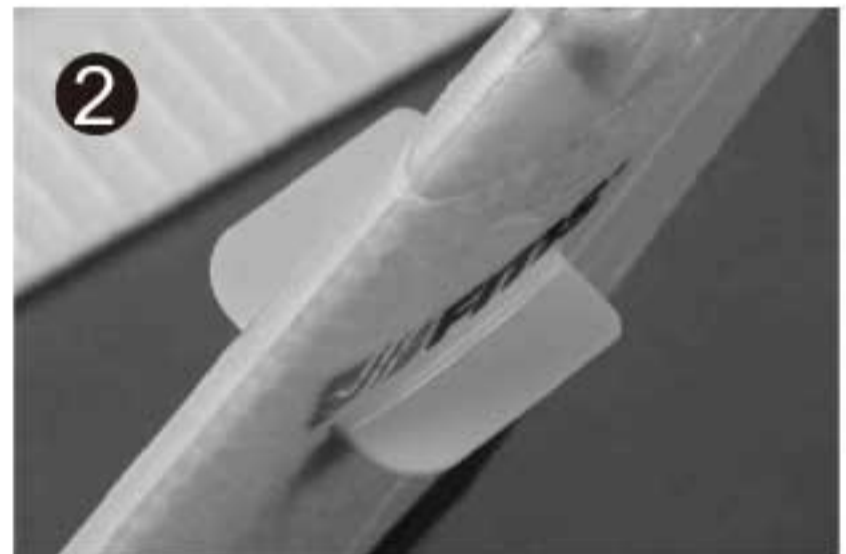
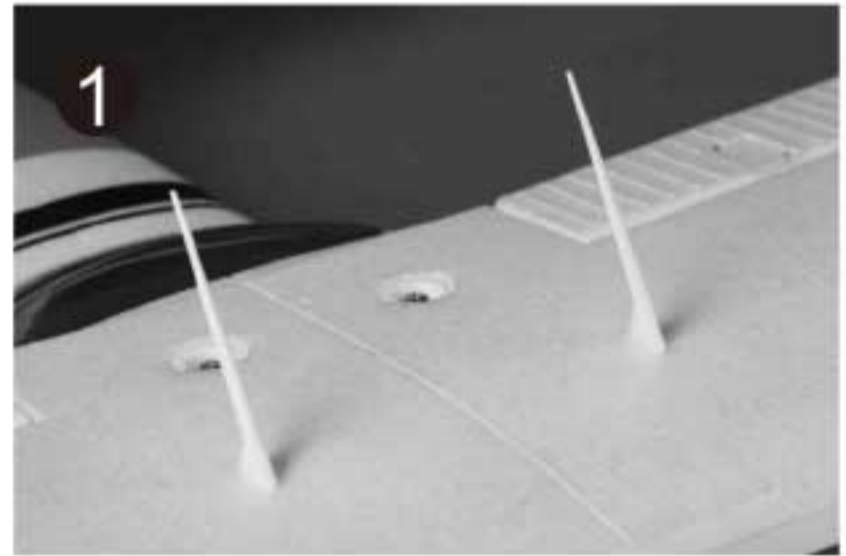

Before the model flying

Find a suitable flying site

Find a flying site clear of buildings, trees, power lines and other obstructions. Until you know how much area will be required and have mastered flying your plane in confined spaces, choose a site which is at least the size of two to three football fields – a flying field specifically for R/C planes is best. Never fly near people– especially children who can wander unpredictably.

Perform the range check of your plane

As a precaution, an operational ground range test should be performed before the first flight each time you go out. Performing a range test is a good way to detect problems that could cause loss of control such as low batteries, defective or damaged radio components, or radio interference. This usually requires an assistant and should be done at the actual flying site you will be using.

First turn on the transmitter, then install a fully-charged battery into the fuselage. Connect the battery and install the hatch.

Remember, use care not to bump the throttle stick, otherwise, the propeller / fan will turn and possibly cause damage or injury.

Note: Please refer to your Transmitter Manual that came with your radio control system to perform a ground range check. If the controls are not working correctly or if anything seems wrong, do not fly the model until you correct the problem. Make certain all the servo wires are securely connected to the receiver and the transmitter batteries have a good connection.

Monitor your flight time

Monitor and limit your flight time using a timer (such as one on a wrist watch or in your transmitter if available). When the batteries are getting low you will usually notice a performance drop before the ESC cuts off motor power, so when the plane starts flying slower you should land. Often (but not always) power can be briefly restored after the motor cuts off by holding the throttle stick all the way down for a few seconds.

To avoid an unexpected dead-stick landing on your first flight, set your timer to a conservative 4 minutes. When your alarm sounds you should land right away.

Flying course

Take off

While applying power slowly steer to keep the model straight, the model should accelerate quickly. As the model gains flight speed, you will want to climb at a steady and even rate. The Sky trainer 182 will climb out at a nice angle of attack (AOA).

Flying

Always choose a wide-open space for flying your plane. It is ideal for you to fly at a sanctioned flying field. If you are not flying at an approved site, always avoid flying near houses, trees, wires and buildings. You should also be careful to avoid flying in areas where there are many people, such as busy parks, schoolyards, or soccer fields. Consult laws and ordinances before choosing a location to fly your aircraft. After takeoff, gain some altitude. Climb to a safe altitude and begin to trim the model till it's tracks well through all aspects of flight, including high speed passes, inverted flight, loops, and point rolls.

Landing

Land the model when you hear the motor pulsing (LVC) or if you notice a reduction in power. If using a transmitter with a timer, set the timer so you have enough flight time to make several landing approaches.

Recharge the battery and repair the model as needed. The model's three point landing gear allows the model to land on hard surfaces. Align model directly into the wind and fly down to the ground. Fly the airplane down to the ground using 1/4-1/3 throttle to keep enough energy for proper flare. Before the model touches down, always fully decrease the throttle to avoid damaging the propeller or other components. The key to a great landing is to manage the power and elevator all the way to the ground and set down lightly on the main landing gear. After a few flights you will find the model can be set down lightly on the mains and you can hold the nose wheel off balancing the model on the mains till it slows and gently settles the nose.

Maintenance

Repairs to the foam should be made with foam safe adhesives such as hot glue, foam safe CA, and 5 min epoxy. When parts are not repairable, see the Spare Parts List for ordering by item number.

Always check to make sure all screws on the aircraft are tightened. Pay special attention to make sure the bullet of the rotor adaptor is firmly in place before every flight.

Troubleshooting

Problem	Possible Cause	Solution
Aircraft will not respond to the throttle but responds to other controls.	<ul style="list-style-type: none"> - ESC is not armed. - Throttle channel is reversed. 	<ul style="list-style-type: none"> - Lower throttle stick and throttle trim to lowest settings. - Reverse throttle channel on transmitter.
Extra propeller noise or extra Vibration.	<ul style="list-style-type: none"> - Damaged spinner, propeller, motor, or motor mount. - Loose propeller and spinner parts. - Propellor installed backwards. 	<ul style="list-style-type: none"> - Replace damaged parts. - Tighten parts for propeller adapter, propeller and spinner.
Reduced flight time or aircraft underpowered.	<ul style="list-style-type: none"> - Flight battery charge is low. - Propeller installed backward. - Flight battery damaged. 	<ul style="list-style-type: none"> - Remove and install propeller correctly. - Completely recharge flight battery. - Replace flight battery and obey flight battery instructions.
Control surface does not move, or is slow to respond to control inputs.	<ul style="list-style-type: none"> - Control surface, control horn, linkage or servo damage. - Wire damaged or connections loose. 	<ul style="list-style-type: none"> - Replace or repair damaged parts and adjust controls. - Do a check of connections for loose wiring.
Controls reversed.	Channels are reversed in the transmitter.	Do the Control Direction Test and adjust controls for aircraft and transmitter.
<ul style="list-style-type: none"> - Motor loses power. - Motor power pulses then motor loses power. 	<ul style="list-style-type: none"> - Damage to motor, or battery. - Loss of power to aircraft. - ESC uses default soft Low Voltage Cutoff(LVC). 	<ul style="list-style-type: none"> - Do a check of batteries, transmitter, receiver, ESC, motor and wiring for damage (replace as needed). - Land aircraft immediately and Recharge flight battery.
LED on receiver flashes slowly.	Power loss to receiver.	<ul style="list-style-type: none"> - Check connection from ESC to receiver. - Check servos for damage. - Check linkages for binding.

AMA

If you are not already a member of the AMA, please join, The AMA is the governing body of model aviation and membership provided liability insurance coverage, protects modelers' rights and interests and is required to fly at most R/C sites.

Academy of Model Aeronautics

5151 East Memorial Drive

Muncie, IN 47302-9252

Ph.(800)435-9262

Fax(765)741-0057

Or via the Internet at: <http://www.modelaircraft.org>



Academy of Model Aeronautics National Model Aircraft Safety Code Effective January 1, 2011

- A. GENERAL:** A model aircraft is a non-human-carrying aircraft capable of sustained flight in the atmosphere. It may not exceed limitations of this code and is intended exclusively for sport, recreation and/or competition.
All model flights must be conducted in accordance with this safety code and any additional rules specific to the flying site.
1. Model aircraft will not be flown:
 - (a) In a careless or reckless manner.
 - (b) At a location where model aircraft activities are prohibited.
 2. Model aircraft pilots will:
 - (a) Yield the right of way to all man carrying aircraft.
 - (b) See and avoid all aircraft and a spotter must be used when appropriate.
(AMA Document #540-D-See and Avoid Guidance.)
 - (c) Not fly higher than approximately 400 feet above ground level within three (3) miles of an airport, without notifying the airport operator.
 - (d) Not interfere with operations and traffic patterns at any airport, heliport or seaplane base except where there is a mixed use agreement.
 - (e) Ensure the aircraft is identified with the name and address or AMA number of the owner on the inside or affixed to the outside of the model aircraft.
(This does not apply to model aircraft flown indoors).
 - (f) Not operate aircraft with metal-blade propellers or with gaseous boosts except for helicopters operated under the provisions of AMA Document #555.
 - (g) Not operate model aircraft while under the influence of alcohol or while using any drug which could adversely affect the pilot's ability to safely control the model.
 - (h) Not operate model aircraft carrying pyrotechnic devices which explode or burn, or any device which propels a projectile or drops any object that creates a hazard to persons or property.

AMA

Exceptions:

- ◆ Free Flight fuses or devices that burn producing smoke and are securely attached to the model aircraft during flight.
- ◆ Officially designated AMA Air Show Teams (AST) are authorized to use devices and practices as defined within the Team AMA Program Document (AMA Document #718).
- 3. Model aircraft will not be flown in AMA sanctioned events, air shows or model demonstrations unless:
 - (a) The aircraft, control system and pilot skills have successfully demonstrated all maneuvers intended or anticipated prior to the specific event.
 - (b) An inexperienced pilot is assisted by an experienced pilot.
- 4. When and where required by rule, helmets must be properly worn and fastened. They must be OSHA, DOT, ANSI, SNELL or NOCSAE approved or comply with comparable standards.

B. RADIO CONTROL (RC)

1. All pilots shall avoid flying directly over unprotected people, vessels, vehicles or structures and shall avoid endangerment of life and property of others.
2. A successful radio equipment ground-range check in accordance with manufacturer's recommendations will be completed before the first flight of a new or repaired model aircraft.
3. RC model aircraft must use the radio-control frequencies currently allowed by the Federal Communications Commission (FCC). Only individuals properly licensed by the FCC are authorized to operate equipment on Amateur Band frequencies.
4. RC model aircraft will not operate within three (3) miles of any pre-existing flying site without a frequency-management agreement (AMA Documents #922-Testing for RF Interference; #923- Frequency Management Agreement)
5. With the exception of events flown under official AMA Competition Regulations, excluding takeoff and landing, no powered model may be flown outdoors closer than 25 feet to any individual, except for the pilot and the pilot's helper(s) located at the flight line.
6. Under no circumstances may a pilot or other person touch a model aircraft in flight while it is still under power, except to divert it from striking an individual. This does not apply to model aircraft flown indoors.
7. RC night flying requires a lighting system providing the pilot with a clear view of the model's attitude and orientation at all times.
8. The pilot of a RC model aircraft shall:
 - (a) Maintain control during the entire flight, maintaining visual contact without enhancement other than by corrective lenses prescribed for the pilot.
 - (b) Fly using the assistance of a camera or First-Person View (FPV) only in accordance with the procedures outlined in AMA Document #550.

C. FREE FLIGHT

1. Must be at least 100 feet downwind of spectators and automobile parking when the model aircraft is launched.
2. Launch area must be clear of all individuals except mechanics, officials, and other fliers.
3. An effective device will be used to extinguish any fuse on the model aircraft after the fuse has completed its function.



Email:info@fmsmodel.com
[Http://www.fmsmodel.com](http://www.fmsmodel.com)