

DOMINATOR T-REX 700X Top Combo

INSTRUCTION MANUAL 使用說明書

RH70E35AT

ALIGN



Contents

1	INTRODUCTION 前言
1~2	SAFETY NOTES 安全注意事項
3	EQUIPMENT REQUIRED FOR ASSEMBLY 自備設備
3	PACKAGE ILLUSTRATION 包裝說明
4	MODEL STANDARD EQUIPMENT DIFFERENCE 標準配備版本說明
5	SAFETY CHECK BEFORE FLYING 飛行前安全檢查重要事項
6~18	ASSEMBLY SECTION 組裝說明
19	INSTALLATION FOR ESC 無刷調速器安裝
20	EQUIPMENT INSTALLATION 各項設備配置圖
21	BATTERY INSTALLATION ILLUSTRATION 電池安裝示意圖
21	CANOPY ASSEMBLY 機頭罩安裝
22	ELECTRIC EQUIPMENT ILLUSTRATION 電子設備連接配置圖示
22~23	MICROBEAST PLUS FLYBARLESS MANUAL 無平衡翼系統使用說明
24	SERVO SETTING AND ADJUSTMENT 伺服器設定調整
24	ADJUSTMENTS FOR GYRO AND TAIL NEUTRAL SETTING 陀螺儀與尾翼中立點設定調整
25	PITCH AND THROTTLE SETTING 主槳翼螺距與油門設定
26	POWER COLLOCATION REFERENCE 原裝動力數據參考
27	BRUSHLESS SPEED CONTROLLER INSTRUCTION MANUAL 無刷調速器使用說明
28~30	FLIGHT ADJUSTMENT AND SETTING 飛行動作調整與設定
31	TROUBLESHOOTING 飛行中狀況排除



MICROBEAST PLUS
6-AXIS MEMS SENSOR SYSTEM FOR RC-MODELS



Thank you for purchasing Align products. Please read the manual carefully before installing and be sure to retain the manual for future reference. All pictures shown are for illustration purpose only. Actual product may vary due to product enhancement. Specifications, contents of parts and availability are subject to change, ALIGN RC is not responsible for inadvertent errors in this publications.

承蒙閣下選用亞拓遙控世界系列產品，謹表謝意。使用前，請務必詳閱本說明書，相信一定能夠給您帶來相當大的幫助，也請您妥善保管這本說明書，以做為日後參考。本公司將不對此印刷物之異動負責，也無法主動通知消費者任何更新或異動。所有圖片僅用於展示目的。產品可能因改良而有些不同。本說明書內記載的材質、規格或零件包裝之內容物如有異動，請依亞拓官網公告為主。

Thank you for buying ALIGN Products. The T-REX 700X Dominator Helicopter is designed as an easy to use, full featured Helicopter R/C model capable of all forms of rotary flight. Please read the manual carefully before assembling the model, and follow all precautions and recommendations located within the manual. Be sure to retain the manual for future reference, routine maintenance, and tuning. The T-REX 700X Dominator is a new product developed by ALIGN. It features the best design available on the Micro-Heli market to date, providing flying stability for beginners, full aerobatic capability for advanced fliers, and unsurpassed reliability for customer support.

感謝您選購亞拓產品，為了讓您容易方便的使用 T-REX 700X Dominator 直昇機，請您詳細的閱讀完這本說明書之後再進行組裝以及操作這台直昇機，同時請您妥善的保存這本說明書，作為日後進行調整以及維修的參考。T-REX 700X Dominator 是由亞拓自行研發的新產品，不論您是需求飛行穩定性的初學者或是追求性能的飛行愛好者，T-REX 700X Dominator 將是您最佳的選擇。

WARNING LABEL LEGEND 標誌代表涵義

	FORBIDDEN 禁止 Do not attempt under any circumstances. 在任何禁止的環境下，請勿嘗試操作。
	WARNING 警告 Mishandling due to failure to follow these instructions may result in damage or injury. 因為疏忽這些操作說明，而使用錯誤可能造成財產損失或嚴重傷害。
	CAUTION 注意 Mishandling due to failure to follow these instructions may result in danger. 因為疏忽這些操作說明，而使用錯誤可能造成危險。

IMPORTANT NOTES 重要聲明

R/C helicopters, including the T-REX 700X Dominator are not toys. R/C helicopter utilize various high-tech products and technologies to provide superior performance. Improper use of this product can result in serious injury or even death. Please read this manual carefully before using and make sure to be conscious of your own personal safety and the safety of others and your environment when operating all ALIGN products. Manufacturer and seller assume no liability for the operation or the use of this product. This product is intended for use only by adults with experience flying remote control helicopters at a legal flying field. After the sale of this product we cannot maintain any control over its operation or usage.

As the user of this product, you are solely responsible for operating it in a manner that does not endanger yourself and others or result in damage to the product or the property of others.

T-REX 700X Dominator 遙控直昇機並非玩具，它是結合了許多高科技產品所設計出來的休閒用品，所以商品的使用不當或不熟悉都可能造成嚴重傷害甚至死亡，使用之前請務必詳讀本說明書，勿輕忽並注意自身安全。注意！任何遙控直昇機的使用，製造商和經銷商是無法對使用者於零件使用的損耗異常或組裝不當所發生之意外負任何責任，本產品是提供給有操作過模型直昇機經驗的成人或有相當技術的人員在旁指導於當地合法遙控飛行場飛行，以確保安全無虞下操作使用，產品售出後本公司將不負任何操作和使用控制上之任何責任與安全責任。

做為本產品的使用者，您，是唯一對於您自己操作的環境及行為負全部的責任之人。

We recommend that you obtain the assistance of an experienced pilot before attempting to fly our products for the first time. A local expert is the best way to properly assemble, setup, and fly your model for the first time. The T-REX 700X Dominator requires a certain degree of skill to operate, and is a consumer item. Any damage or dissatisfaction as a result of accidents or modifications are not covered by any warranty and cannot be returned for repair or replacement. Please contact our distributors for free technical consultation and parts at discounted rates when you experience problems during operation or maintenance. As Align Corporation Limited has no control over use, setup, final assembly, modification or misuse, no liability shall be assumed nor accepted for any resulting damage or injury. By the act of use, setup or assembly, the user accepts all resulting liability.

模型商品屬於需高操作技術且為消耗性之商品，如經拆裝使用後，會造成不等情況零件損耗，任何使用情況所造成商品不良或不滿意，將無法於保固條件內更換新品或退貨，如遇到使用操作維修問題，本公司會盡分公司或代理商將提供技術指導、特價零件供應服務。對使用者的不當使用、設定、組裝、修改、或操作不良所造成的破壞或傷害，本公司無法控制及負責。任何使用、設定、組裝、修改、或操作不良所造成的破壞、意外或傷害，使用者應承擔全部責任。

SAFETY NOTES 安全注意事項



- Fly only in safe areas, away from other people. Do not operate R/C aircraft within the vicinity of homes or crowds of people. R/C aircraft are prone to accidents, failures, and crashes due to a variety of reasons including, lack of maintenance, pilot error, and radio interference. Pilots are responsible for their actions and damage or injury occurring during the operation or as a result of R/C aircraft models.
- Prior to every flight, carefully check rotorhead spindle shaft screws and tail blade pin screws, linkage balls and screws, ensure they are firmly secured.
- 遙控模型飛機、直昇機屬高危險性商品，飛行時務必遠離人群，為組裝不當或機件損壞、電子控制設備不良，以及操控上的不熟悉、都有可能導致飛行失控損傷等不可預期的意外，請飛行者務必注意飛行安全，並需了解自負疏忽所造成任何意外之責任。
- 每趟飛行前須仔細檢查，主旋翼次座槳軸螺絲、尾旋翼次座槳絲，以及機身各部位球頭、螺絲，確實上緊螺絲才能升空飛行。



LOCATE AN APPROPRIATE LOCATION 遠離障礙物及人群

R/C helicopters fly at high speed, thus posing a certain degree of potential danger. Choose a legal flying field consisting of flat, smooth ground without obstacles. Do not fly near buildings, high voltage cables, or trees to ensure the safety of yourself, others and your model. For the first practice, please choose a legal flying field. Do not fly your model in inclement weather, such as rain, wind, snow or darkness.

遙控飛機飛行時具有一定的速度，相對的也會存在著危險性，場地的選擇也相對的重要，請需遵守當地法規到合法遙控飛行場地飛行。務必選擇在空曠合法專屬飛行場地，並必須注意周圍沒有行人、高樓、建築物、高壓電線、樹木等等，避免操控的不當造成自己與他人財產的損壞。

請勿在下雨、打雷等惡劣天氣下操作，以確保本身及機體的安全。



NOTE ON LITHIUM POLYMER BATTERIES 鋰聚電池注意事項

Lithium Polymer batteries are significantly more volatile than alkaline or Ni-Cd/Ni-MH batteries used in RC applications. All manufacturer's instructions and warnings must be followed closely. Mishandling of Li-Po batteries can result in fire. Always follow the manufacturer's instructions when disposing of Lithium Polymer batteries.

鋰聚電池跟一般在RC使用的鹼性電池、鎳氫電池比較起來是相對危險的。請嚴格遵守鋰聚電池說明書之使用注意事項，不恰當使用鋰聚電池，可能造成火災並威脅生命財產安全，切勿大意！

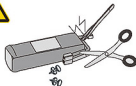

PREVENT MOISTURE 遠離潮濕環境

R/C models are composed of many precision electrical components. It is critical to keep the model and associated equipment away from moisture and other contaminants. The introduction or exposure to water or moisture in any form can cause the model to malfunction resulting in loss of use, or a crash. Do not operate or expose to rain or moisture.

遙控機內部也是由許多精密的電子零件組成，所以必須絕對的防止潮濕或水氣，避免在浴室或雨天時使用，防止水氣滲入機身內部而導致機件及電子零件故障而引發不可預期的意外！



PROPER OPERATION 勿不當使用本產品

Please use the replacement of parts on the manual to ensure the safety of instructors. This product is for R/C model, so do not use for other purpose.

請勿自行改造加工，任何的升級改裝或維修，請使用至拓產品目錄中的零件，以確保結構的安全，請確認於產品限界內操作，請勿過載使用，並勿用於安全、法令外其它非法用途。



OBTAIN THE ASSISTANCE OF AN EXPERIENCED PILOT 避免獨自操控

Before turning on your model and transmitter, check to make sure no one else is operating on the same frequency. Frequency interference can cause your model, or other models to crash. The guidance provided by an experienced pilot will be invaluable for the assembly, tuning, trimming, and actual first flight or unforeseen danger may happen. (Recommend you to practice with computer-based flight simulator.)

在飛行場飛行前，需確認是否相同頻率的同類正進行飛行，因為開放相同頻率的發的機體將導致自己與他人立即不確定等意外危險。遙控飛機操控技巧在學習初期有著一定的難度，要盡量避免獨自操作飛行，需有經驗的人士在旁指導，才可操控飛行，否則將可能造成不可預期的意外發生。(動線電腦模擬器及老手指導是入門必要的選擇)



SAFE OPERATION 安全操作

Operate this unit within your ability. Do not fly under tired condition and improper operation may cause in danger. Never take your eyes off the model or leave it unattended while it is turned on. Immediately turn off the model and transmitter when you have landed the model.

請於自己能力內及需要一定技能範圍內操作這台遙控機，過於疲勞、精神不佳或不當操作，意外發生風險將可能提高，不可在視線範圍外進行，降落後也請馬上關閉遙控機及遙控器電源。



ALWAYS BE AWARE OF THE ROTATING BLADES 遠離運轉中零件

During the operation of the helicopter, the main rotor and tail rotor will be spinning at a high rate of speed. The blades are capable of inflicting serious bodily injury and damage to the environment. Be conscious of your actions, and careful to keep your face, eyes, hands, and loose clothing away from the blades. Always fly the model a safe distance from yourself and others, as well as surrounding objects.

遙控機主旋翼與尾旋翼運轉時會以高轉速下進行，在高轉速下的位置會造成自己與他人或在環境上的嚴重損傷，請勿觸摸運轉中的主旋翼與尾旋翼，並保持安全距離以避免造成危險及損壞。



KEEP AWAY FROM HEAT 遠離熱源

R/C models are made of various forms of plastic. Plastic is very susceptible to damage or deformation due to extreme heat and cold climate. Make sure not to store the model near any source of heat such as an oven, or heater. It is best to store the model indoors, in a climate-controlled, room temperature environment.

遙控飛機多半是以PA 縮維或聚乙之烯、電子商品為主要材質，因此要盡量遠離熱源、日曬，以避免因高溫而變形甚至導致損壞的可能。



RADIO TRANSMITTER AND ELECTRONIC EQUIPMENT REQUIRED FOR ASSEMBLY

自備遙控及電子設備

Transmitter(6-channel or more, Helicopter system)
發射器(六點以上直昇機模式遙控器)Intelligent Balance Charger RCC-6CX
智慧型分壓充電器 RCC-6CXor
或RCC-300 Battery Charger
RCC-300 充電器Receiver(6-channel or more)
接收器(六點以上)Remote Receiver
衛星天線22.2V 6S 4500-5200mAh Li-Po Battery x 2 pcs
22.2V 6S 4500-5200mAh Li-Po 電池 x 2

ADDITIONAL TOOLS REQUIRED FOR ASSEMBLY 自備工具

[H70118]
Swashplate Leveler
十字盤校正器[HET80001]
AP800 Digital Pitch Gauge
AP800 數位靠尺[HETMT901]
Multi-function Tester
多功能檢測計Phillips Screw Driver
十字螺絲起子
φ 3.0/φ 1.8mmCutter Knife
刀子Hexagon Screw Driver
六角螺絲起子
3mm/2.5mm/2mm/1.5mmNeedle Nose Pliers
尖嘴鉗Oil
潤滑油CA Glue
瞬間膠Grease
潤滑油

PACKAGE ILLUSTRATION 包裝說明





















ALIGN

700 Carbon Fiber Blades x 1set
700 碳纖維主旋翼 x 1 組700FLT6
Carbon Fiber Tail Boom x 1
碳纖維尾管 x 1700HB19
700HB18
800HB5
700HT
700FLH16
700FLH13Quick Finder
零件快速圖Canopy
機頭罩700HB17
700EFLZ
700HG3850MX (490KV/4535) Motor x 1
850MX (490KV/4535) 無刷馬達 x 1Microbeast PLUS
Flybarless System x 1
無平衡翼系統 x 1DS830M High Voltage Brushless Servo x 3
DS830M 高電壓無刷伺服器 x 3DS835M High Voltage Brushless Servo x 1
DS835M 高電壓無刷伺服器 x 1200A Brushless ESC x 1
200A 無刷調速器 x 1

There are many versions of T-REX 700X Dominator for your choice. The TOP Combo includes additional electronics and other equipment. The Instruction Manual will refer to the T-REX 700X Dominator TOP Combo. You may purchase any additional items referenced in the instruction manual or any spare parts for other 700X Dominator version by referring to more product information in this manual.

T-REX 700X Dominator 系列商品有多種版本可作為選擇，除標準配備會因您購買的商品版本而有些微不同，在組裝、設定上都是一致的，在此我們以 TOP Combo 作為操作範例，您也可依類番面上的商品資訊來增添其他選購商品。



T-REX 700X DOMINATOR TOP COMBO STANDARD EQUIPMENT		T-REX 700X DOMINATOR TOP COMBO 標準配備 [RH70E35AT]	
 700HC7	 700FLH	 700HB17	 700HB11B
 700HB19	 700HB18	 800HB5	 700HG3
 700HT17	 700HT	 700EFLZ	 700FLT6
 700 Carbon Fiber Blades x 1set 700 碳纖維主旋翼 x 1 組	 M4x4 Set Screw x 2 M4x4 止洩螺絲 x 2 Motor Slant Thread Pinion Gear 13T x 1 馬達斜齒輪 13T x 1	 RCM-BL850MX Brushless Motor (490KV/453S) x 1 RCM-BL850MX 無刷馬達 (490KV/453S) x 1	 Microbeast PLUS Flybarless System x 1 無平衡翼系統 x 1
 200A Brushless ESC x 1 200A 無刷调速器 x 1	 DS830M High Voltage Brushless Servo x 3 DS830M 高電壓無刷伺服器 x3	 DS835M High Voltage Brushless Servo x 1 DS835M 高電壓無刷伺服器 x 1	 Repair Towel x 1 維修桌巾 X 1

CAREFULLY INSPECT BEFORE REAL FLIGHT 請嚴格執行飛行前的檢查義務

- Before flying, please check to make sure no one else is operating on the same frequency for the safety.
- Before flight, please check if the batteries of transmitter and receiver are enough for the flight.
- Before turn on the transmitter, please check if the throttle stick is in the lowest position. IDLE switch is OFF.
- When turn off the unit, please follow the power on/off procedure. Power ON- Please turn on the transmitter first, and then turn on receiver. Power OFF- Please turn off the receiver first and then turn off the transmitter. Improper procedure may cause out of control, so please to have this correct habit.
- Before operation, check every movement is smooth and directions are correct. Carefully inspect servos for interference and broken gear.
- Check for missing or loose screws and nuts. See if there is any cracked and incomplete assembly of parts. Carefully check main rotor blades and rotor holders. Broken and premature failures of parts possibly cause a dangerous situation.
- Check all ball links to avoid excess play and replace as needed. Failure to do so will result in poor flight stability.
- Check if the battery and power plug are fastened. Vibration and violent flight may cause the plug loose and result in out of control.
- 每次飛行前應先確認所使用的頻率是否會干擾他人，以確保您自身與他人的安全。
- 每次飛行前確定您發射器與接收器電池的電量是在足夠飛行的狀態。
- 開機前確認油门搖桿是否位於最低點，熄火降落開關，定速開關(IDLE)是否於關閉位置。
- 開機時必須遵守電源開關機器的程序，開機時應先開啟發射器後，再開啟接收器電源；關機時應先關閉接收器後，再關閉發射器電源。不正確的開機程序可能會造成失控的現象，影響自身與他人的安全，請養成正確的习惯。
- 開機前請先確定直昇機各個動作是否順暢，及方向是否正確，並檢查伺服器的動作是否有干涉或崩齒的情形，使用故障的伺服器將導致不可預期的危險。
- 飛行前確認沒有缺少或鬆動的螺絲與螺帽，確認沒有組裝不完整或損毀的零件，仔細檢查主旋翼夾座的部位，損壞或組裝不完整的零件不僅影響飛行，更會造成不可預期的危險。注意：每次飛行前的安全檢查、保養、及更換損耗零件，請確實嚴格執行以確保安全。
- 檢查所有的連接頭是否有鬆脫的情形，過鬆的連接頭應更新，否則將造成直昇機無法操控的危險。
- 確認電池及電源接頭是否固定牢靠，飛行中的震動或激烈的飛行，可能造成電源接頭鬆脫而造成失控的危險。

When you see the marks as below, please use relative glue or grease to ensure flying safety.

標有以下符號之組裝步驟，請配合上膠或油，以確保黏附零件使用之可靠度。



• CA : Apply small amount of CA glue to fix.

瞬間膠：使用適量瞬間膠固定

• R48 : Apply small amount of Anaerobic Retainer to fix.

厌氧膠：使用適量厌氧膠固定

• T43 : Apply small amount of Thread Lock to fix.

螺絲膠：使用適量螺絲膠

• OIL : Add small amount of OIL.

潤滑油：添加適量潤滑油

• Grease : Add small amount of Grease.

潤滑膏：添加適量潤滑膏

When assembling ball links, make sure the "A" character faces outside.

各項塑膠球連接頭扣接時，"A"字請朝外。



Keep plastic parts away from heat.
塑膠件避免接近熱源。



CA Glue
瞬間膠



Anaerobic Retainer
厌氧膠



Thread Lock
螺絲膠



Grease
潤滑膏



Oil
潤滑油

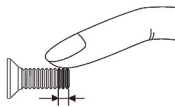

T43 Glue width : approx. 1mm
T43 上膠寬度約 1mm

1. Anaerobic Retainer (R48) is green penetrating threadlocker and is used to fix the metal tube before assembly at temperatures up to +180°C.
2. Thread Lock(T43) is blue low strength threadlocker and is applied to the small screw(threads) or metal parts before assembly to prevent loosening. Ensure to apply only a small amount and wipe surplus off. When disassembling, recommend to heat the metal joint about 15Seconds.
3. Grease is kind of lubricant additive which is applied to the one-way bearings or thrust bearing.

◎Based on parts physical attributes, please apply small amount of the relative glue or grease accordingly to prevent any parts damage or loosening or unexpected danger happened.

1. 厌氧膠 (R48) 為綠色高強度快速固化的厌氧膠，適合於金屬管狀固定用，可耐高溫至 180°C。
2. 螺絲膠 (T43) 為藍色低強度螺絲膠，適合小型螺絲；使用於金屬內外徑或膠合螺絲時，請務必適量使用，必要時請用手去擦多餘膠量，欲拆卸時可於金屬接合部位加熱約 15 秒。
3. 潤滑油 (Grease) 為膏狀潤滑油，適用於單向軸承或止推軸承。

◎上述各類功能膠(油)請依零件屬性需求自行準備並斟酌其用量，以達到最佳組裝狀態，避免因使用不當造成零件損壞或不可預期的意外發生。

700FLH16



Thrust Bearing
止推軸承 (φ 10.2x φ 18x5.5mm) x 2



Bearing
軸承 (φ 10x φ 19x5mm) x 4



Spindle Bearing Spacer
橫軸止推桿可 (φ 10x φ 16x1mm) x 2



Socket Collar Screw
圓頭內六角軸套螺絲 (M3x6mm)x4



Thrust bearing and washer for radial bearing are wear items; therefore, it is recommended to inspect after every 20 flights and replaced as necessary. For flights with high headspeed, the inspection interval should be reduced to ensure flight safety.

止推軸承及橫軸墊圈屬於飛行消耗品，建議每 20 趟定期檢查及更換，高主旋翼轉速飛行時，請縮短定期檢查之週數，以確保飛行安全。



Apply Grease on Thrust Bearing.
止推軸承塗上潤滑油

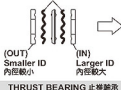

THRUST BEARING 止推軸承

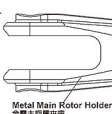

Metal Main Rotor Holder
金屬主旋翼夾座

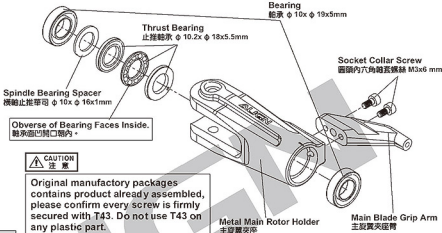

Spindle Bearing Spacer
橫軸止推桿可 (φ 10x φ 16x1mm)

Obverse of Bearing Faces Inside.
軸承面凹對口朝內。



Original manufactory packages contains product already assembled, please confirm every screw is firmly secured with T43. Do not use T43 on any plastic part.

原廠零件包裝如果是組裝品，請確認再確認各螺絲是否鎖緊上部，請注意 T43 不可用在任何的塑膠材質上。

Apply a small amount of T43 thread lock when fixing a metal part.
螺絲鎖附於金屬件請使用適量 T43 (螺絲膠)。

700FLH16

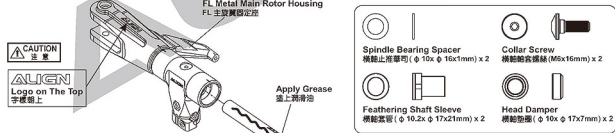

ALIGN
Logo on The Top
字樣朝上

FL Metal Main Rotor Housing
FL 主旋翼固定座

Apply Grease
塗上潤滑油



The feathering shaft and feathering shaft socketscrews are wear items, and thus should be inspected for replacement after every 100 flights. For flights with high head speed, the inspection interval should be reduced to ensure flight safety.

主旋翼橫軸組、橫軸和橫軸螺絲屬於飛行消耗品，建議每 100 趟定期檢查及更換，高主旋翼轉速飛行時，請縮短定期檢查之週數，以確保飛行安全。

Apply a small amount of T43 thread lock when fixing a metal part.
螺絲鎖附於金屬件請使用適量 T43 (螺絲膠)。



Please apply a small amount of T43 when tightening the feathering shaft socket screws and make sure to tighten firmly, but not over tighten. Suggest using a torque wrench or torque lock when tightening screws. Torque value 20.0kg.cm

橫軸螺絲鎖附時請注意鎖附之緊度與使用適量的螺絲膠，建議搭配扭力扳手或扭力機鎖附螺絲，鎖定扭力值為 20.0kg.cm。



ALIGN
Logo on The Top
字樣朝上

Feathering Shaft
橫軸
φ 7x φ 10x106.5mm

Feathering Shaft Sleeve
橫軸套管
φ 10.2x φ 17x21mm

Head Damper
橫軸墊圈
φ 10x φ 17x7mm

Spindle Bearing Spacer
橫軸止推桿可
φ 10x φ 16x1mm



ALIGN
Logo on The Top
字樣朝上



700FLH16

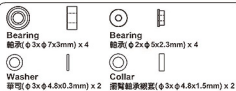

700FLH13



700FLH16A

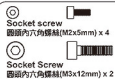

Apply a small amount of T43 thread lock when fixing a metal part.
螺絲鎖附於金屬件時使用適量 T43 (螺絲膠)。



Original manufactory packages contains product already assembled, please confirm every screw is firmly secured with T43. Do not use T43 on any plastic part.

原裝零件出廠包裝如果是組裝品，請需再確認各螺絲是否鎖緊上膠，請注意 T43 不可塗在任何的塑膠材質上。

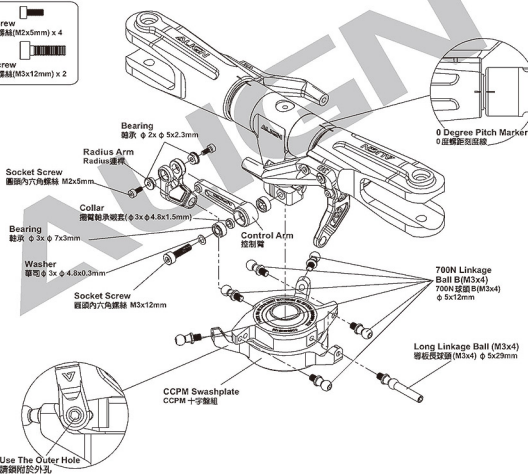

700FLH16A

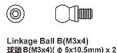

Linkage Ball B (M3x4)
球頭B (M3x4) (φ 5x10.5mm) x 2



Collar
連桿套 x 2



M4 Nut
M4 防鬆螺帽 x 2



Elevator Ball Link
升降桿連桿頭 x 2



Socket Collar Screw
圓頭內六角鎖緊螺絲 (M4x24mm) x 2



Washer
華司 (φ 4x φ 8x1mm) x 2



760X Linkage Rod (A)
760X 連桿 A (M3x35mm) x 2

1. While assembling T-REX 700X/700L V2 FL Rotor Housing, please be sure to include a φ 4x φ 8x1 mm washer between Socket Collar Screw and M4 Nut. Confirm the main shaft is firmly assembled on rotor housing. This will ensure main shaft longevity and flight safety.

2. Main rotor head and main shaft wear items; it is recommended to inspect after every 200 flights and replace as necessary. For high headspeed flights, the inspection interval should be reduced to ensure flight safety.

3. Make sure to check and change the parts if any failure due to normal deterioration or mechanical wear to prevent expected danger during high headspeed flight.

1. T-REX 700X/700L V2 FL 新款旋翼頭組裝時，請於主旋翼固定座鎖附的軸套螺絲及防鬆螺帽之間加上一片 φ 4x φ 8x1mm 華司，可確保主旋翼固定座能確實鎖緊於主軸上，請試用手上左右搖動，不可有鬆動或搖晃的情形發生。

2. 旋翼頭組及主軸屬於飛行消耗品，建議每200趟定期檢查及更換，請縮短定期檢查之趟數，並確實檢查您的直昇機，以確保飛行安全。

3. 若發生人為組裝不當或機件損毀造成模型商品摔機時，請務必詳細確實檢查，強烈建議更換損壞的部件，避免高主旋翼轉速為行奇，發生不可預期的意外。

Apply a small amount of T43 thread lock when fixing a metal part.
螺絲鎖附於金屬件請使用適量 T43 (螺絲膠)。

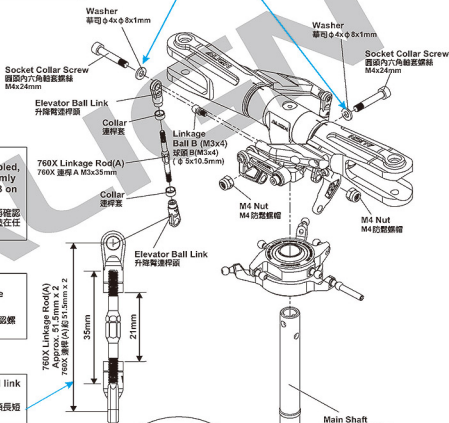

Original manufactory packages contains product already assembled, please confirm every screw is firmly secured with T43. Do not use T43 on any plastic part.

原裝零件出廠包裝如果是組裝品，請再確認各螺絲是否鎖緊上膠。請注意 T43 不可塗在任何的塑膠材質上。



Already assembled by Factory. Before flying, please check if the screws are fixed with glue.

原裝組裝完成品，每一次飛行前請先確認螺絲是否已上膠不會鬆動。



You may adjust the length of ball link when tracking is off while flight.

若飛行中有變換情形，可適當調整連桿頭長短改善。



For installation, make sure the "Check Point" is face upward, then use plier or wrench grasp the center of hexagonal rod to adjust its suitable length, turns clockwise to decrease the length, turns counter clockwise to increase the linkage length.

組裝時請將連桿中間有溝槽辨識端朝上。請使用尖嘴鉗或扳手轉動連桿中間六角柱部位調整適當長度，順時針轉動為調短連桿長度；逆時針轉動則為調長連桿長度。

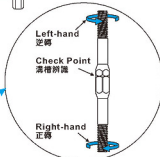

700HB17A



Bearing
轴承 (φ 12x φ 24x6mm) x 3



Bearing
轴承 (φ 6x φ 13x5mm) x 1



Socket Screw
圓頭內六角螺絲 (M2.5x8mm) x 6



Socket Button Head Collarscrew
半圓頭內六角輪蓋螺絲 (M3x6mm) x 6

Recommend sanding the marked position as right illustration with a waterproof abrasive paper(#800-1000) to avoid the wires of electric parts to be cut.

建議於右圖色塊標示處，使用#800~1000水砂紙打磨，可防止電子設備電線被割破。

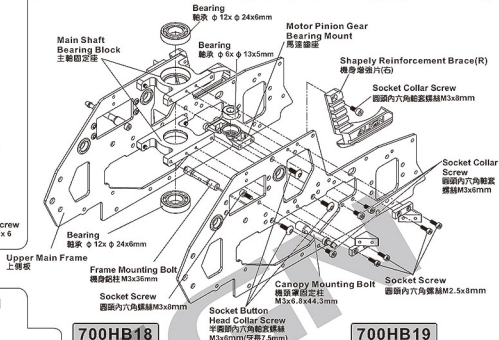
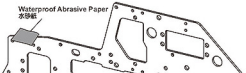

700HB18A



Socket Screw
圓頭內六角螺絲 (M3x8mm) x 2



Canopy Mounting Bolt
機頂罩固定柱 (M3x6.8x44.3mm) x 2

700HB18



Frame Mounting Bolt
機身鎖柱 (M3x36mm) x 1

700HB19



Socket Collar Screw
圓頭內六角輪蓋螺絲 (M3x6mm) x 6

700HB11B



Socket Collar Screw
圓頭內六角輪蓋螺絲 (M3x6mm) x 14



Socket Screw
圓頭內六角螺絲 (M3x10mm) x 4

700HB18A



Socket Screw
圓頭內六角螺絲 (M3x8mm) x 2



Front Canopy Mounting Bolt
前機頂罩固定柱 (M3x6.8x18mm) x 2

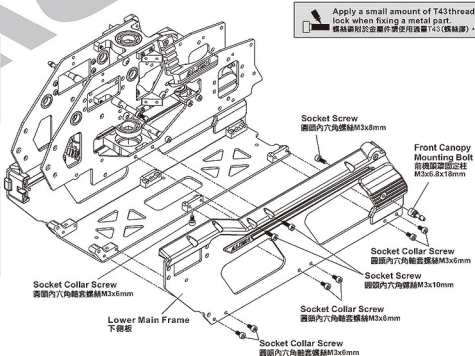



Main frame assembly key point :

First do not fully tighten the screws of main frames and put three bearings through the main shaft to check if the movements are smooth. The bottom bracket must be firmly touched the level table top(glass surface) ; please keep the smooth movements on main shaft and level bottom bracket, then slowly tighten the screws. This assembly can help for the power and flight performance.

機身側板組立重點:

鉸接螺絲先不完全鎖緊，放入主軸貫穿三顆軸承觀察上下移動是否滑順，主軸底座必須與水平桌面（玻璃平面）確實緊貼；請保持主軸滑順且底座平行桌面並保留鎖緊螺絲，正確側板的組裝對動力與飛行性能有顯著幫助。

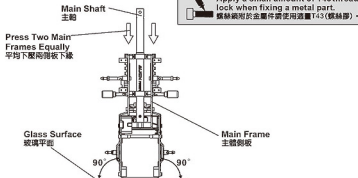

700HB18



700HG2A



700HB18A



700HB11B

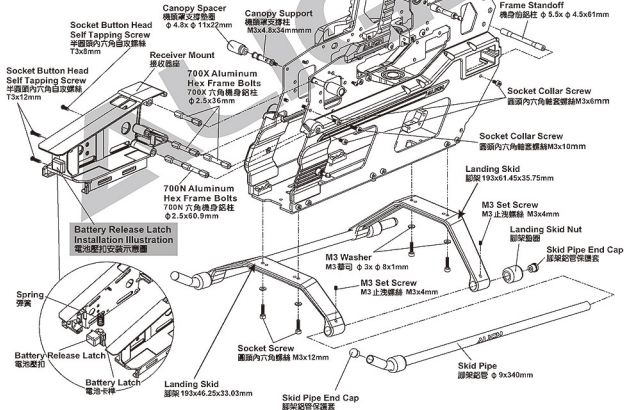

PROGRESSIVE LIGHTWEIGHT LANDING SKID

前衛新型前傾輕量化設計的腳架

Landing skid is tilted 5 degree forward which improves crashworthiness.

新型腳架減輕衝擊，為前傾 5 度密衝設計。



700HZ17



Linkage Ball C (M2.5x4)
球頭 C (M2.5x4) (φ 5x12mm) x 3



Socket Button Head Screw
半圓頭內六角螺絲 (M2.5x10mm) x 4

700HB17A



Socket Button Head Screw
半圓頭內六角螺絲 (M2.5x10mm) x 8

Apply a small amount of T43 thread lock when fixing a metal part.
螺絲固定於金屬件請使用適量 T-43 (螺絲膠)。

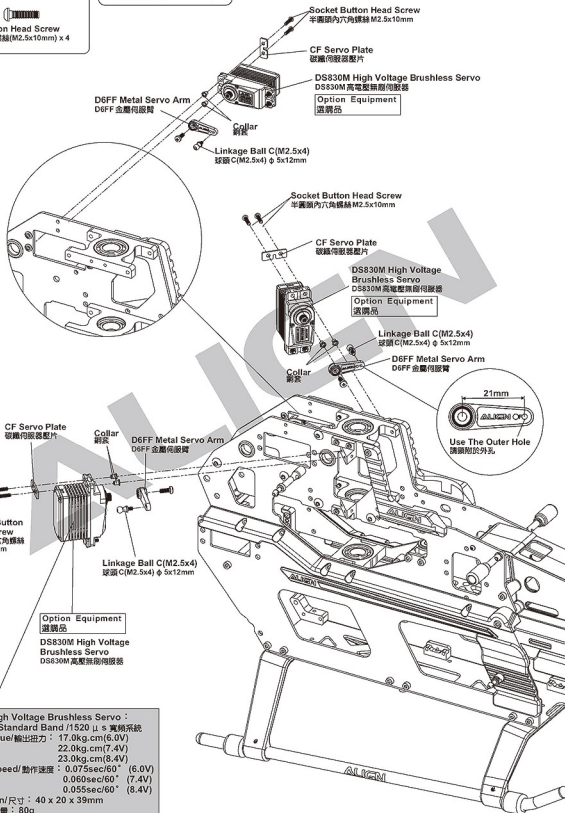

- DS830M High Voltage Brushless Servo :
- 1.1520 μ s Standard Band / 1520 μ s 寬頻系統
 2. Stall Torque/輸出扭力 : 17.0kg.cm (6.0V)
22.0kg.cm (7.4V)
23.0kg.cm (8.4V)
 3. Motion Speed/動作速度 : 0.075sec/60° (6.0V)
0.060sec/60° (7.4V)
0.055sec/60° (8.4V)
 4. Dimension/尺寸 : 40 x 20 x 39mm
 5. Weight/重量 : 80g

700HB17A



700HB18



700HZ17



- DS835M High Voltage Brushless Servo :
- 1.1520 μ s Standard Band / 1520 μ s 寬頻系統
 - 2.Stall Torque/輸出扭力 : 8.0kg.cm(6.0V)
10.0kg.cm(7.4V)
12.5kg.cm(8.4V)
 - 3.Motion Speed/動作速度 : 0.04sec/60° (6.0V)
0.03sec/60° (7.4V)
0.028sec/60° (8.4V)
 - 4.Dimension/尺寸 : 40 x 20 x 391mm
 - 5.Weight/重量 : 72g

DS835M High Voltage
Brushless Servo
DS835M 高壓無刷伺服器
Option Equipment
選購品

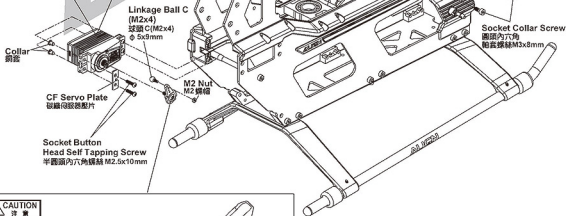

700HZ13



Make sure the motor mount is fully fastened before fasten the motor pinion gear mount.
先將馬達固定座鎖緊固定後，再將馬達齒座鎖緊。

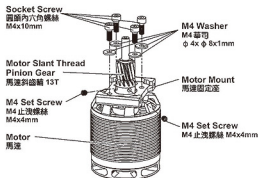

Apply a small amount of T43 thread lock when fixing a metal part.
螺絲鎖附於金屬件請使用適量 T43 (螺絲膠)。

While assembling the motor mount, please make sure to properly loose M4 Set screw on 13T motor gear first, after fully fasten the motor mount with the motor pinion, then fasten back the M4 Set screw completely.

安裝馬達罩時，請先將 13T 馬達斜齒輪的 M4x4mm 止鎖螺絲適當放鬆，當馬達固定座和馬達齒座固定鎖好後，再將馬達止鎖螺絲鎖緊。

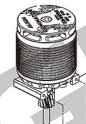

Please trim away the other servo horns, and fasten linkage ball on the outer hole.
請先將原附十字舵角片切掉多餘的另三邊，並將球頭鎖附於最外孔

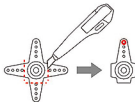

Make sure the motor mount is fully fastened before fasten the motor pinion gear mount.
先將馬達固定座鎖緊固定後，再將馬達齒座鎖緊。

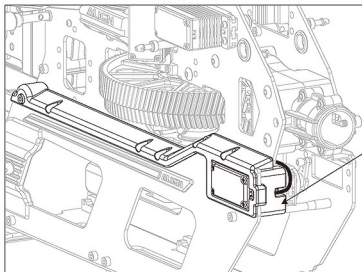

INNOVATIVE SERVO EMBEDDED MOUNT

獨創伺服器嵌入式基座

Servo mount manufactured using the latest composite material technology to integrate carbon fiber and POM (polyacetal), which efficiently strengthens its protective function and reduces abrasion of signal wires.

採用複合材質技術將碳纖維與POM塑膠材質運用於伺服器座，有效增強保護效果並降低訊號線的磨損。



注意

Please refer to the diagram, the wire straps can be used to fix the servo wires to the frame, make sure to ensure all wires are neatly tucked to the frame without any pinching to prevent any unexpected danger in flight.

請參考圖示位置將伺服器接線使用束帶固定於側板的孔位，飛行前請再次確認伺服器接線已緊固於機身側板，避免因飛行時磨損線材而造成不可預期的危險。

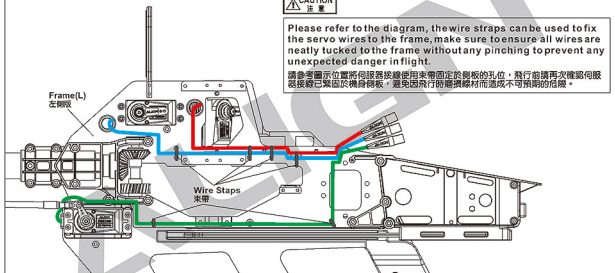

注意

Please refer to the diagram, the wire straps can be used to fix the servo wires to the frame, make sure to ensure all wires are neatly tucked to the frame without any pinching to prevent any unexpected danger in flight.

請參考圖示位置將伺服器接線使用束帶固定於側板的孔位，飛行前請再次確認伺服器接線已緊固於機身側板，避免因飛行時磨損線材而造成不可預期的危險。

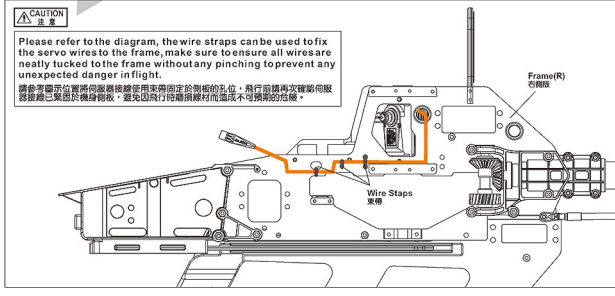

700HT17

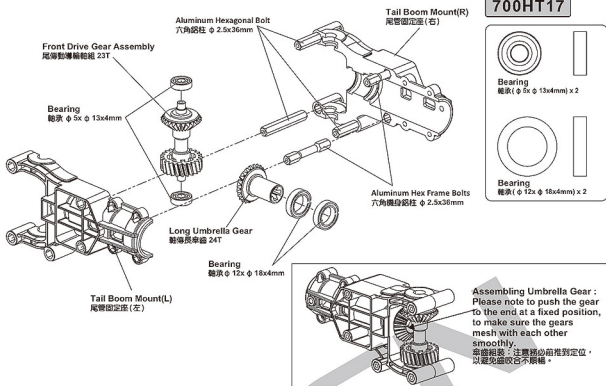

700HT10

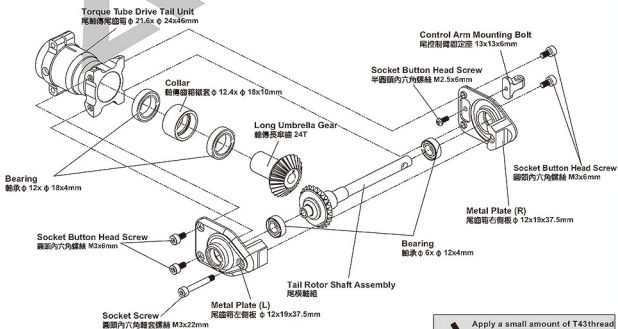

Apply a small amount of T43 thread lock when fixing a metal part.
螺絲鎖附於金屬件時使用適量 T-43 (螺絲膠)。

700HT10

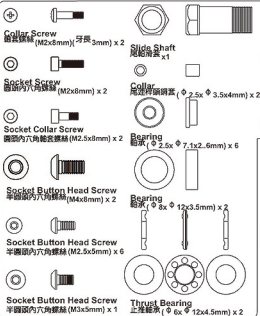

THRUST BEARING 止推軸承

Apply Grease on Thrust Bearing.

在止推軸承處塗抹潤滑油。



THRUST BEARING 止推軸承

Make sure to tighten the screws on each side with average strength, but no unilaterally tighten, or it may cause interference during rotation.
組裝尾旋翼控制組時，上、下螺絲必須選擇平均力度鎖緊，不可單邊過緊，否則會造成干涉滑動不順暢。

While assembly the slide shaft, please use suitable amount of T43 on the thread. Please do not use R48 or other high strength thread lock to avoid damages while maintenance or repairs.
組立尾輪滑套時，請使用適量的T43螺絲鎖在螺牙上。嚴禁使用R48高強度合性鎖膠膠的膠合過緊，以避免日後拆裝維護零件之損傷。

Assembling Umbrella Gear: Please note to push the gear to the end at a fixed position, to make sure the gears mesh with each other smoothly.
總裝傘齒：注意務必將傘齒推到位，以免齒咬合不順暢。

Socket Button Head Screw
半圓頭內六角螺絲 M2.5x5mm

Tail Pitch Bellcrank Mount
尾固定連接座

Slide Shaft
尾輪滑套

T43

Bearing
軸承 φ 8x φ 12x3.5mm

Bearing Holder
尾輪軸承固定座

Collar
尾輪齒環螺絲 2.5x φ 3.5x4mm

Control Link
尾控制連桿彈簧

Socket Screw
圓頭內六角螺絲 M2x8mm

Bearing
軸承 φ 6x φ 10x3mm

Tail Rotor Hub
尾旋翼 T 型座 φ 12.8x44.2mm

M4 Set Screw
M4 止鎖螺絲 M4x4mm

Bearing
軸承 φ 2.5x φ 7.1x φ 2.6mm

Socket Button Head Screw
半圓頭內六角螺絲 M2.5x5mm

Slide Shaft
尾輪滑套

Collar
尾輪齒環螺絲 (牙環 3mm) M2x8mm

T Type Arm
尾 T 型控制臂

Apply a small amount of T43 thread lock when fixing a metal part.
鎖緊螺絲時於金屬零件請使用適量 T43 (螺絲膠)。

Socket Button Head Screw
半圓頭內六角螺絲 M2.5x5mm

Socket Button Head Screw
半圓頭內六角螺絲 M3x5mm

Linkage Ball C (M3x3.5)
環頭 C (M3x3.5) φ 5x8.5mm

Rudder Control Arm
尾舵控制臂

Apply a small amount of T43 thread lock when fixing a metal part.
鎖緊螺絲時於金屬零件請使用適量 T43 (螺絲膠)。

Apply a small amount of T43 thread lock when fixing a metal part.
鎖緊螺絲時於金屬零件請使用適量 T43 (螺絲膠)。

CAUTION
注意
Aim tail rotor hub at the concave of the tail rotor shaft and apply thread lock on the set screw. The tail rotor hub and screws are wear items, and thus should be inspected for replacement after every 100 flights. For flights with high wear speed, the inspection interval should be reduced to ensure flight safety.
組裝尾旋翼時將尾輪座推入尾輪軸的凹面並鎖上螺絲，請鎖緊止鎖螺絲上膠。尾旋翼 T 型座與螺絲屬於消耗件，建議每 100 飛行時檢查並更換。若高速飛行時，檢查間隔應縮短以確保飛行安全。

CAUTION
注意
Please tighten M2x8mm collar screw firmly but not over tightened. Over tighten the screw will cause the operation of control link to be fight. 鎖緊 M2x8mm 螺絲螺絲請使用適量力鎖，過度鎖緊會造成尾輪控制連桿滑動不順。

CAUTION
注意
After complete the tail rotor assembly, please check if it rotates smoothly. 尾旋翼總組裝完成後請確認尾旋翼夾座轉動滑順。

700HT15



CAUTION

The Metal Tail Rotor Holder is assembled at the factory, make sure to apply little thread lock on screws and tighten them back appropriately before starting to fly. Suggest to use torque wrench or torque lock for tightening screws with the torque value 5.0 kg.cm.

原裝尾旋翼夾座為預組裝，請務必選擇適量螺絲鎖緊螺絲。起飛前請注意適當鎖緊即可，建議使用扭力或扭力鎖鎖緊，扭力值為 5.0 kg.cm。

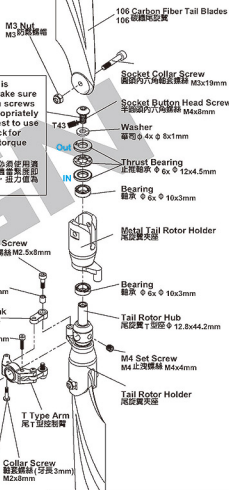

Apply a small amount of T43 thread lock when fixing a metal part.
鎖緊螺絲時於金屬零件請使用適量 T43 (螺絲膠)。

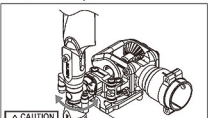

CAUTION
注意
After complete the tail rotor assembly, please check if it rotates smoothly. 尾旋翼總組裝完成後請確認尾旋翼夾座轉動滑順。

Apply a small amount of T43 thread lock when fixing a metal part.
鎖結劑於金屬零件鎖使用薄層T43(螺絲膠)。

Already assembled by factory, please note to check again.
已組裝完成，請務必再行確認。

Socket Screw
蓋頭內六角螺絲
M3x10mm

When assembling into the tail boom, please apply some oil on the surface, to make it smooth during the assembling and keep it vertical with the torque tube for smooth rotation.
插入尾管內時，外表抹些潤滑油，以確保平面壓入尾管中並與尾傳動軸保持垂直，讓尾輪傳動順暢。

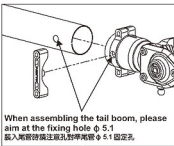

When assembling the tail boom, please aim at the fixing hole $\phi 5.1$.
新加入尾管時請注意孔對準尾管 $\phi 5.1$ 固定孔。

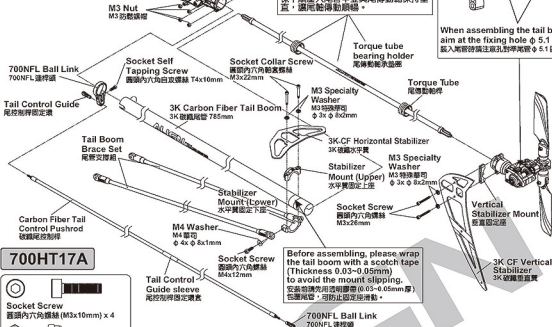

700HT17A



700NT2EA

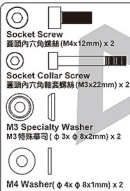

700HT10



700HT6A



700FLT6



700FLT7



TIP TO FIX THE TORQUE TUBE 傳動軸輪承固定定位要領

Please apply some CA glue to fix bearing on the torque tube, avoid CA glue from the bearing side or may cause the bearing stuck. When assembling into the tail boom, please apply some oil and use the attached torque tube helper to press the bearing holder of the torque tube into the tail boom horizontally.
請以少量CA將軸承固定於尾傳動軸上，避免CA達到軸承的防護面而導致軸承卡死，插入尾管內時，尾傳動軸承座圈外表抹些潤滑油，利用隨附軸承安裝套將尾傳動軸承座圈平行壓入尾管中不可歪斜。

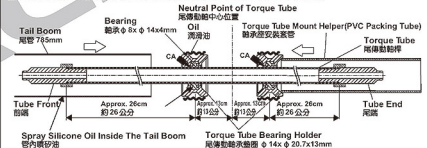

CAUTION
注意

Skewed Torque Tube bearing holder will interfere with torque tube rotation and cause unusual vibration.
尾傳動軸承座安裝歪斜會造成傳動軸旋轉不順及尾部異常震動等問題。

CAUTION
注意

After moving the tail control rod adjustment to recommended position, glue the sleeve to carbon tail control rod with instant glue.
尾控制桿固定位置調整建議位置後，再將尾控制桿固定套與碳纖維尾控制桿接觸面以適量瞬間膠固定。



Original manufacturer packages contains product already assembled, please confirm every screw is firmly secured with T43. Do not use T43 on any plastic part.

原裝零件出廠包裝如果屬組裝品，請確認每顆各螺絲是否鎖緊上膠。請注意 T43 不可用在任何的塑膠材質上。

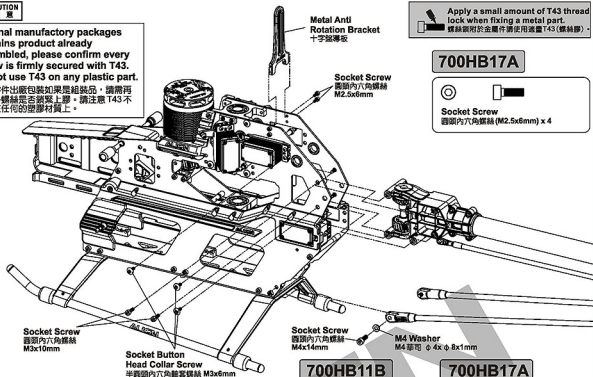

700HB17A

Socket Screw
圓頭內六角螺絲 (M2.5x6mm) x 4

Tail Boom Fixing Screw
尾管固定螺絲

700HT17A

Socket Screw
圓頭內六角螺絲 (M4x8mm) x 2

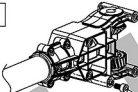

Socket Screw
圓頭內六角螺絲
M4x8mm

700HB11B

Socket Screw
圓頭內六角螺絲 (M4x14mm) x 2

M4 Washer
M4 華司 ($\phi 4x \phi 8x1mm$) x 2

700HB17A

Socket Screw
圓頭內六角螺絲 (M3x10mm) x 4

Socket Button Head Collar Screw
半圓頭內六角軸蓋螺絲 (M3x6mm) x 6

800HB5



Bearing
軸承 ($\phi 15x \phi 21x4mm$) x 2



One-way Bearing
單向軸承 ($\phi 15x \phi 23x11mm$) x 1



One-way Bearing Cover
單向軸承上蓋
 $\phi 21x \phi 15.8x26mm$



Spacer
700 隔向墊片
 $\phi 18x \phi 22.7x0.7mm \times 1$

Socket Screw
圓頭內六角螺絲 (M2.5x6mm) x 6

Socket Screw
圓頭內六角螺絲 (M3x8mm) x 6

Socket Screw
圓頭內六角螺絲 M3x8mm

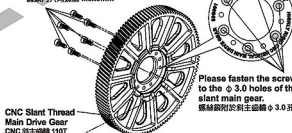

One-way Bearing Shaft
單向軸承夾 $\phi 12x \phi 15x41.5mm$

Spacer
700 隔向墊片
 $\phi 18x \phi 22.7x0.7mm$

One-way Bearing Collar
單向軸承外環 $\phi 6x \phi 23x11.6mm$

Apply Grease
塗上潤滑油

One-way Bearing Mount
單向軸承下蓋
 $\phi 15x \phi 23x8.5mm$

Bearing
軸承 $\phi 15x \phi 21x4mm$

One-way Bearing
單向軸承 $\phi 15x \phi 23x11mm$

Please note the direction of the bearing.
請注意軸承方向



Original manufacturer packages contains product already assembled, please confirm every screw is firmly secured with T43. Do not use T43 on any plastic part.

原裝零件出廠包裝如果屬組裝品，請確認每顆各螺絲是否鎖緊上膠。請注意 T43 不可用在任何的塑膠材質上。

Before tightening the screw, please rotate the bearing and check the concentricity of the bearing in order to have the screw firmly secured, to avoid the bearing stuck or heavy load at one side and cause slip.
安裝螺絲前請旋轉軸承檢查其同心度良好後，才能將螺絲鎖緊上膠，以避免造成卡死或螺絲向一端造成打滑。

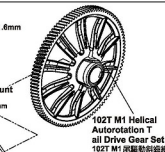

Socket Screw
圓頭內六角螺絲 M2.5x8mm

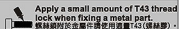

When tightening the main blade fixing screw, please tighten it firmly, but not over tighten, or it may cause the damage of main blade holder and result in danger.

鎖緊主旋翼螺絲時注意適量鎖緊即可，過緊可能導致主旋翼夾座受損，飛行意外發生。

700FLH16A

Main Blade Fixing Screw

鎖主旋翼用螺絲



Socket Collar Screw

圓頭內六角軸套螺絲 (M5x32mm) x 2



M5 Nut

M5 防鬆螺帽 x 2

800HB5

Socket Collar Screw

圓頭內六角軸套螺絲 (M4x27mm) x 1



M4 Nut

M4 防鬆螺帽 x 1

[H70118] Washplate Leveler

十字螺位正器

Optional Equipment

另購品

Main Shaft

主軸

Horizontally Level

水平

Swashplate

十字槓



While using Flybarless system, please use the swashplate leveler to calibrate swashplate. Adjust the length of servo linkage rod to make sure the swashplate is leveled before start setting up to ensure the gyro provides the best performance.

使用無平衡系統，請務必使用十字螺槓位正十字槓，調整伺服螺桿長度，確保十字槓達到水平狀態，再進行基本機體設定，這樣才能確保飛行性能達到最佳效果。

700 Carbon Fiber Blades
700 碳纖維主旋翼

Socket Collar Screw
圓頭內六角軸套螺絲
M5x32mm

M5 Nut
M5 防鬆螺帽

Linkage Rod(A)
連桿 A M3x41mm

Elevator Ball Link
升降桿連桿頭

Standard Equipment :

Main shaft spacer(1)

標準品：主軸墊片(1)

φ 12x φ 16x1mm

Spare part : Main shaft spacer(0.8)

備品：主軸墊片(0.8)

φ 12x φ 16x0.8mm

主軸墊片(0.5)

φ 12x φ 16x0.5mm

主軸墊片(0.3)

φ 12x φ 16x0.3mm

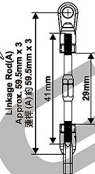

Linkage Rod(A)
連桿 (A) 約 99.5mm x 3

M1 Slant Thread Main Drive Gear Set
M1 斜主齒輪組

M4 Nut
M4 防鬆螺帽

Socket Screw
圓頭內六角軸套螺絲
M4x27mm

The lower edge of main gear need to be lined up with lower edge of pinion gear. This will ensure smooth meshing, and avoid interference between pinion's base and main gear which can lead to unusual wear.

馬達齒下緣必須與主齒輪下緣水平切齊，如此才能確保齒輪傳動順暢，避免馬達主齒輪與新型斜主齒輪產生異常干涉磨損。

700HZ18

Elevator Ball Link

升降桿連桿頭 x 6

Collar

連桿套 x 6

Linkage Rod(A)

連桿 A (M3x41mm) x 3

Apply a little amount of T43 thread lock when fixing a metal part.
 鎖絲鎖附於金屬件請使用適量T43(鎖絲膠)。



Hobby Wing Platinum HV 200A Brushless ESC
 Hobby Wing Platinum HV 200A無刷調速器



Hook and Loop Tape(Fuzzy)
 魔術沾(雜毛狀)

Hook and Loop Tape(Hooked)
 魔術沾(勾狀)

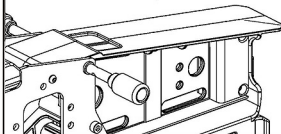

Receiver Mount
 接收器座

CAUTION
 注意

Original manufactory packages contains product already assembled, please confirm every screw is firmly secured with T43. Do not use T43 on any plastic part.

原裝零件出廠包裝如果是組裝品，請再次確認各螺絲是否緊緊上膠，請注意T43不可塗在任何的塑膠材質上。

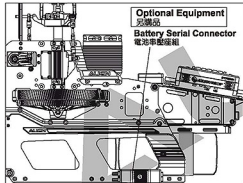

Optional Equipment
 選購款
 Battery Serial Connector
 電池串接線組

CAUTION
 注意

The ideal location to mount the ESC, if the gyro is mounted in suggested position 1, is as far forward as necessary to avoid any contact with gyro. The top of the ESC (fan) should be as close as possible to the opening located at the top of the canopy's front window. This allows air flow to pass over the ESC, improving the efficiency of heat dissipation. Failure to mount in this location may affect flight performance due to excessive heat by the ESC.

無刷調速器安裝時，建議盡量往正上方安裝固定，散熱效果較好；安裝位置過低可能會因機殼覆蓋散熱不佳，導致無刷調速器過熱而影響飛行性能。

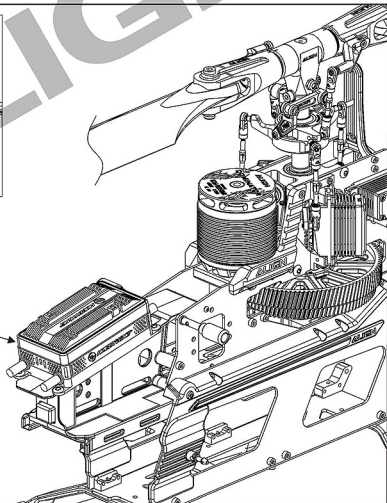

A MOUNTING ORIENTATION OF MICROBEAST PLUS MICROBEAST PLUS的安裝方向

Please visit Align download area to get the completed instruction manual at Align website.

更多詳細的設定操作說明請至官網下載專區下載。
<http://www.align.com.tw/beastx/>

Microbeast PLUS provides 8 different direction choices can be installed on any position of helicopter.

Microbeast PLUS 提供8種不同方向選擇，可以安裝在機體的任何一個位置。

THE COLOR OF THE STATUS-LED SHOWS THE CURRENTLY SELECTED ORIENTATION:
 LED指示燈狀態顯示安裝方向：



Status LED Off*
 Status-LED 燈熄滅*



Status LED Flashing Purple
 Status-LED 燈
 紫色閃爍



Status LED Purple
 Status-LED 燈紫色



Status LED Flashing Red
 Status-LED 燈
 紅色閃爍



Status LED Red
 Status-LED 燈紅色



Status LED Flashing Blue
 Status-LED 燈藍色閃爍



Status LED Blue
 Status-LED 燈藍色



Status LED Flashing Red/Blue
 Status-LED 燈
 紅色紫色閃爍的燈

Front
 機頭方向

* Factory Setting

* 出廠預設值



Apply a small amount of T43 thread lock when fixing a metal part.
 螺絲鎖附於金屬件時請使用適量T43 (螺絲膠)。



Original manufactory packages contains product already assembled, please confirm every screw is firmly secured with T43. Do not use T43 on any plastic part.

原裝零件出廠包裝如果是組裝品，請再確認各螺絲是否鎖緊上膠，請注意 T43 不可塗在任何的塑膠材質上。

Microbeast PLUS
 Flybarless System
 (position #1)
 無平衡翼系統 (位置 #1)

Foam Tape
 泡棉

Microbeast PLUS
 Flybarless System
 (position #2)
 無平衡翼系統 (位置 #2)

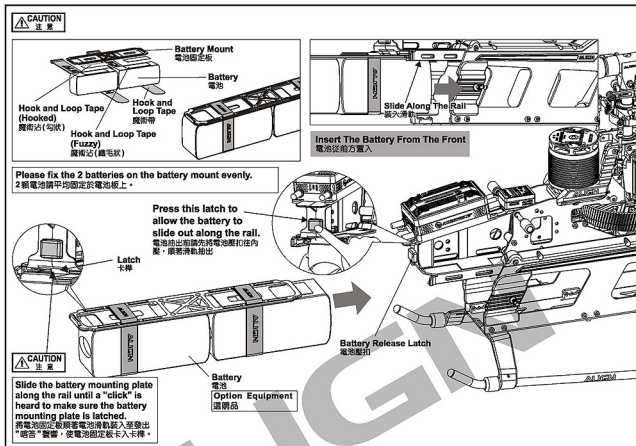

CANOPY ASSEMBLY

機頭罩安裝

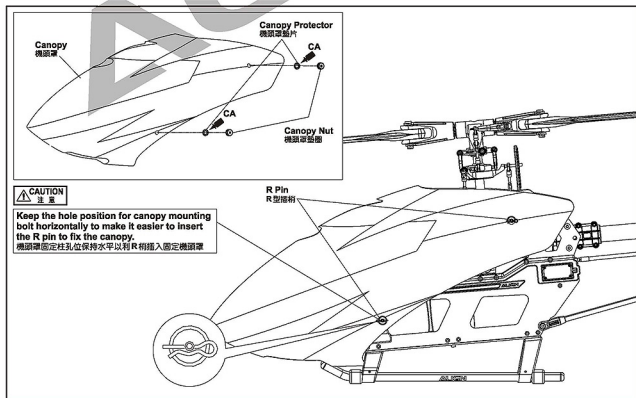

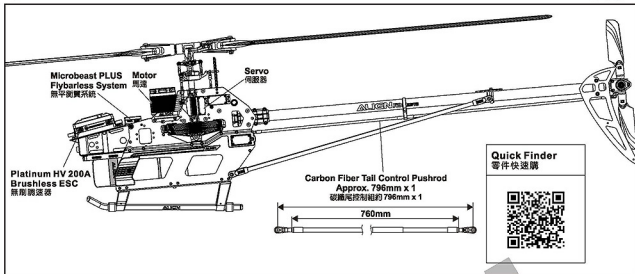

MICROBEAST PLUS FLYBARLESS MANUAL

無平衡翼系統使用說明

ALIGN

MICROBEAST PLUS Flybarless System as ALIGN helicopter standard equipment, must and compatible with ALIGN standard equipment including blades, servos, motor, battery and so on, please refer to flight and setup instruction in this manual.

ALIGN 直升機使用 MICROBEAST PLUS 無平衡翼系統，須搭配ALIGN 直升機標準配件(主旋翼、伺服器、馬達)與飛行操作、設定指示。

USER NOTICE 使用注意事項



1. If assembling and operating the helicopter without using ALIGN standard equipment, including electronic equipment & blades...etc, please make sure there is a sufficiently large and stable power supply to your helicopter. If there is any abnormal voltage or insufficient power supply, suggest to upgrade the flybarless system to MICROBEAST PLUS HD (Optional) for better power back up.
 2. Please refer to BEASTX MICROBEAST PLUS/HD website for MICROBEAST PLUS/HD assembly and setup instruction.
 3. Any over use, incorrect setup, missassembly, incorrect modification or misuse will lead to abnormal voltage, electronic devices damage, structural interference, and insufficient power supply. Make sure to carefully check every assembly and setup refer to the manual instruction prior to every flight to prevent any unforeseen danger.
1. 安裝、操作您的直升機時，如非使用ALIGN 標準配件(含電子配件、主旋翼等)，請務必確定您的供電系統有足夠的供電能力，如發現電壓異常、供電不足，建議您升級使用 MICROBEAST PLUS HD 無平衡翼系統(選配)，以能確保充足、穩定的接收器電壓。
 2. MICROBEAST PLUS/HD 使用、設定、接線，請參照 BEASTX MICROBEAST PLUS/HD 官方說明。
 3. 任何電子配件、零件的設定、組裝、修改或操作不良所造成的電壓異常、電子零件損壞，即可能造成供電不穩定等問題，每趟飛行前須仔細仔細檢查，防止機件及電子零件故障而引發不可預期的意外。

MANUAL LINK 設定操作連結

MICROBEAST PLUS Flybarless System is the latest version out of the factory, please feel at ease using it. You can also link to BEASTX MICROBEAST PLUS/HD website to get the latest version and the latest news. MICROBEAST PLUS Flybarless System has available some different versions, each version has different programming and function, please make sure your Microbeast version and read its correct manual carefully before assembly or upgrading, especially you are upgrade from version V3.2.X. to V4.X.X by yourself. In order to avoid mistake or loss by any misunderstanding, please be sure that you have correct version and follow its setting method accordingly. And please refer to MICROBEAST PLUS V3.2.x and V4.2 instruction manual for operating and setting.

MICROBEAST PLUS 無平衡翼系統，出廠時主程式已是最新版本。您也可以連結至 BEASTX MICROBEAST PLUS/HD 官網查詢，隨時更新最新版本及各項最新訊息。部分版本因升級而設定及功能會有所不同，請確定您的版本並詳閱其說明書，尤其您是由 V3.2.x 升級至 V4.x.x，請務必深入了解版本之間的設定功能，以免錯誤而造成損失。操作設定請同時參閱 V3.2.x 版及 V4.2 版使用說明書。



Please visit Align download area to get the completed instruction manual at Align website.

更多詳細的設定操作說明請至官網下載專區下載。
<http://www.align.com.tw/beastx/>



MICROBEAST PLUS
BLADES MENS SENSOR SYSTEM FOR HD MODELS

PARTS IDENTIFICATION 各部位名稱

MICROBEAST PLUS FLYBARLESS SYSTEM 無平衡翼系統

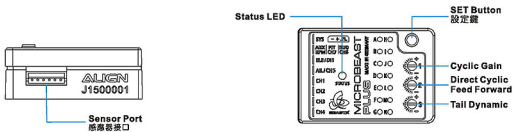

MICROBEAST PLUS FLYBARLESS SYSTEM WIRING DIAGRAM 無平衡翼系統接線示意圖

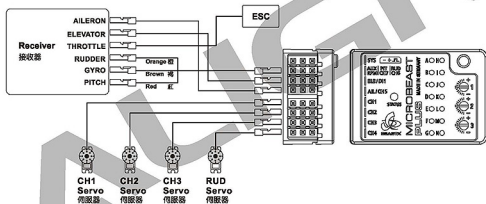

For detail connectivity, please scan QR Code then follow MICROBEAST PLUS manual.

詳細接線方式，請掃描QR Code 連結至MICROBEAST PLUS說明書。



MICROBEAST PLUS HD Flybarless System(Optional) MICROBEAST PLUS HD 無平衡翼系統(選配)

If assembling and operating the helicopter without using ALIGN standard equipment, including electronic equipment & blades...etc, please make sure there is a sufficiently large and stable power supply to your helicopter. If there is any abnormal voltage or insufficient power supply, suggest to upgrade the flybarless system to MICROBEAST PLUS HD (Optional) for better power back up. Please refer to BEASTX website for MICROBEAST PLUS HD assembly and setup instruction.

安裝、操控您的直昇機時，如非使用 ALIGN 標準配件(含電子配件、主旋翼等)，請務必確定您的供電系統有足夠的供電能力，如發現電壓異常、供電不足，建議您升級使用 MICROBEAST PLUS HD 無平衡翼系統(選配)，以能確保充足、穩定的接收器電源。MICROBEAST PLUS HD 使用、設定、接線，請參照 MICROBEAST PLUS HD 官方說明。

To set this option is to turn on the transmitter and connect to BEC power.

Note: For the safety, please do not connect ESC to the brushless motor in order to prevent any accident caused by the motor running during the setting.

此項設定只要開啟發射器，接上BEC電源即可進行操作。

注意：為了安全起見，設定前請先不要將無刷調速器與無刷馬達三條線接上，以免調整時啟動馬達而發生危險。

SERVO CONFIGURATION 伺服器配置

Following the servo configuration diagram on right, plug the servos to Gyro.

請依照右圖顯示的伺服器名稱，將伺服器接到陀螺儀。

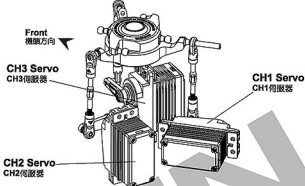

ADJUSTMENTS FOR GYRO AND TAIL NEUTRAL SETTING

陀螺儀與尾翼中立點設定調整

ALIGN

Turn off Revolution mixing (RVMX) mode on the transmitter, then set the gain switch on the transmitter and the gyro to non-head lock mode, or disable gain completely. After setting the transmitter, connect the helicopter power and proceed with rudder neutral point setting. **Note:** When connecting to the helicopter power, please do not touch tail rudder stick and the helicopter, wait for 3 seconds for gyro to enable, and the rudder servo horn should be 90 degrees to the tail servo. Tail pitch slider should be halfway on the tail output shaft. This will be the standard rudder neutral point. After completing this setting, set the gain switch back to heading lock mode, with gain at around 70%.

發射器內陀螺儀設定請關閉混合控制模式，並將發射器上的感度開關與陀螺儀切至“非鎖定模式”或將陀螺儀感度關閉。發射器設定完成後接上直升機電源，即可進行尾舵中立點設定。注意：當接上直升機電源時請勿碰觸尾舵搖桿或旋翼機體，待3秒陀螺儀開機完成後，尾舵伺服臂與尾舵伺服器約成90度，尾翼調整控制組須正確置於尾翼輸出軸中間位置，即為標準尾舵中立點設定，設定完成後，切換至“鎖定模式”，感度設約70%左右。

TAIL NEUTRAL SETTING

尾翼中立點設定

After the gyro is enable and under non-head lock mode, correct setting position of tail servo and tail pitch assembly is as photo. If the tail pitch assembly is not in the middle position, please adjust the length of rudder control rod to trim.

陀螺儀開機後，在非鎖定模式下，尾舵伺服器與尾Pitch控制組正確擺置位置，若尾Pitch控制組未置於中間時請調整尾舵控制桿的長度來修正。

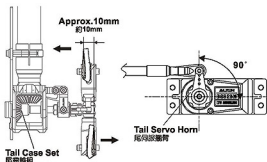

HEAD LOCK DIRECTION SETTING OF GYRO

陀螺儀鎖定方向設定

To check the head lock direction of gyro is to move the tail clockwise and the tail servo horn will be trimmed counterclockwise. If it trims in the reverse direction, please switch the gyro to "REVERSE".

陀螺儀鎖定方向確認，當手搖尾翼時尾舵控制組應逆時鐘擺正，反向時請切換陀螺儀上“鎖定反向”開關修正。

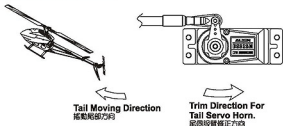



The rotational speed must set below 2,200RPM for safety to prevent any unexpected danger.

主旋翼機的主旋翼有安全使用轉速範圍，飛行時不可超過2,200 rpm，超轉會導致不可預期的危險，甚至危害他人生命財產。

GENERAL FLIGHT 一般飛行模式

GENERAL FLIGHT 一般飛行模式

Throttle 油門	Pitch 螺距
5 100% High Speed 100% 高速	+12°
4 85%	
3 60%~65% Hovering 60%~65% 停懸	+5°
2 40%	
1 0% Low Speed 0% 低速	-2° ~ 0°

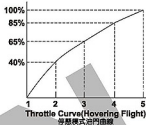

Pitch and Rotation Speed Pitch與轉速關係
TIP: It is recommended to use a lower pitch setting when using higher RPM/Head speed. This will allow for better power.
※配重時: 如果使用較高轉速/頭速動力建議搭配較低 Pitch，將獲得較佳動力效能。

IDLE 1: SPORT FLIGHT

Throttle 油門	Pitch 螺距
5 100%	+10°~+12°
4 75%	
3 70%	+5°
2 75%	
1 80%	-5°

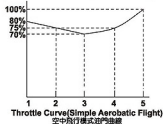

IDLE 2: 3D FLIGHT

Throttle 油門	Pitch 螺距
5 100% High 100% 高	+12°
3 85% Middle 85% 中	0°
1 100% Low 100% 低	-12°

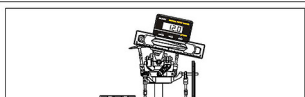
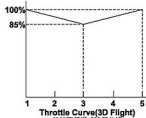

Stick position at high/Throttle 100%/Pitch+12°
搖桿高速/油門100%/Pitch+12°



Stick position at Hovering/Throttle 70%/Pitch+5°
搖桿停懸/油門70%/Pitch+5°

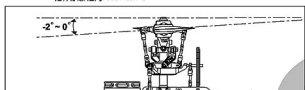

Stick position at low/Throttle 0%/Pitch-2°~0°
搖桿低速/油門0%/Pitch-2°~0°

3D FLIGHT 3D特技飛行模式

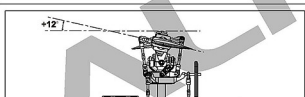

Stick position at high/Throttle 100%/Pitch+12°
搖桿高速/油門100%/Pitch+12°

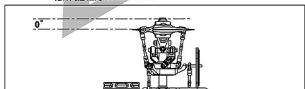

Stick position at middle/Throttle 90%/Pitch 0°
搖桿中速/油門90%/Pitch 0°

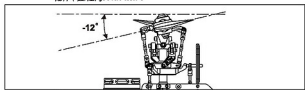

Stick position at low/Throttle 100%/Pitch-12°
搖桿低速/油門100%/Pitch-12°



1. Pitch range : Approx. ±15° .
2. If the pitch is set too high, it will result in shorter flight duration and poor motor performance.
3. Setting the throttle to provide a higher speed is preferable to increasing the pitch too high.

1. 螺距(Pitch)總行程約 ±15° .
2. 過大螺距設定，會導致動力與飛行時間降低。
3. 動力提升以較高轉速的設定方式，優於螺距調大的設定。

RCM-BL850MX (490KV/4535) MOTOR RCM-BL850MX (490KV/4535) 無刷馬達

Power and torque requirements of enthusiasts, the high output 850MX motor was born in Align's R&D lab. With dramatic increase in torque and power output, capable of 5100 watts continuous power output and 11000 watts of burst power!

850MX Motor has passed various thorough inspections made by our technical department, including motive testing, static testing, magnetic field testing, heat resistance and magnetic loss testing, running balance and vibration testing, noise testing, and many hours of actual loading and flying testing, etc. Align is proud to provide the latest innovations in RC Modeling to its customers. Please enjoy your Align products safely.

亞拓特別針對大動力、高扭力之需求，研發設計出極強勁力而生的850MX馬達，動力輸出與扭力表現大幅提升，持續輸出功率達5100W，瞬間最大輸出功率可達11000W。本公司生產的高扭力高轉速850MX馬達，適用於RC電動商品，其高功率高效率率輸出特性，適合電動飛機/電動直昇機之高扭力高轉速驅動動力用途，速度控制可採本公司城市售價規格無刷電子變速器。轉子採用高磁性材料磁鐵磁轆製成，定子採用本廠NC自動繞線與高強度鉚釘組裝確保。耐高壓無刷馬達，心軸採高硬度高韌性粘結承殼及雙ZZ高速精密粘結承殼設計，自經由亞拓獨立開發設計技術，使用壽命長、效率高、耐撞不易變形、耐腐蝕、高效率850型無刷馬達。該項新商品已通過不銜技術單位，實施精密嚴格、靜態、磁場特性、強磁耐高壓磁環、運轉平衡震動及噪音、負載與飛行動態性能等各項嚴格檢測。

SPECIFICATION 尺寸規格

(Unit unit: mm)

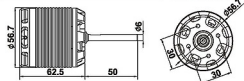

ILLUSTRATION 接線示意圖



KV	KV值	490KV(RPM/V)	Input Voltage	輸入電壓	12S
Stator Diameter	定子外型	45 mm	Stator Thickness	定子高度	35mm
Stator Arms	矽鋼片槽數	12	Magnet Poles	磁鐵槽數	10
Max Continuous Current	最大持續電流	115A	Max Instantaneous Current	最大瞬間電流	250A(2sec)
Max Continuous Power	最大持續功率	5100W	Max Instantaneous Power	最大瞬間功率	11000W(2sec)
Dimension	尺寸	Shaft ϕ 6x56.7x112.5mm	Weight	重量	Approx. 570g

The motor rotates in different direction with different brand ESCs. If the wrong rotating direction happens, please switch any two cables to make the motor rotates in right direction.

由於各品牌電子變速器的馬達旋轉方向不相同，若發生轉向錯誤時，請將馬達與電子變速器的接線任兩條對調即可。

200A BRUSHLESS SPEED CONTROLLER INSTRUCTION MANUAL 無刷調速器使用說明 ALIGN

PRODUCT FEATURES 產品特色



Hobby Wing Platinum HV 200A Brushless ESC can be set up by ALIGN ASBOX Multifunction Programmer. So please scan QR code for ALIGN website start downloading for more information:

<http://www.align.com.tw/download-en/asbox/>

Hobby Wing Platinum HV 200A無刷調速器可透過ALIGN ASBOX多功能設定盒進入參數設定，請掃描QR Code連結至亞拓網站下載相關資訊：<http://www.align.com.tw/download-en/asbox/>

- High performance microprocessor with a running frequency of up to 120 MHz for excellent motor speed-governing and super soft startup.
- Microprocessor powered by independent DC regulator has better anti-interference performance, which greatly reduces the risk of losing control.
- The maximum motor speed can reach 210,000 RPM (for 2 pole motor), 70,000 RPM (for 6 pole motor) and 35,000 RPM (for 12 pole motor).
- Multiple flight modes: Fixed-wing, Helicopter (Linear Throttle), Helicopter (Elf Governor), Helicopter (Store Governor).
- Data logging records the standardized RPM, minimum voltage and maximum temperature of the flight.
- "Restart in auto function" can manually interrupt the auto rotation and quickly restart the motor to avoid crashes caused by incorrect operations.
- WIFI module (sold separately) for programming the ESC wirelessly with your smart phone (iOS or Android).
- internal anti-spark circuitry effectively eliminates electric sparks produced when the ESC is powered on.
- Independent output port for RPM (that is: motor speed) signals.
- Separate programming port for ESC parameter setup through ALIGN ASBOX Multifunction Programmer.
- Separate programming port for ESC programming or parameter setting.
- Multiple protections like thermal shutdown protection, overload protection, over-current protection, etc.
- BEC is separated from other circuits of the ESC, it may keep normal output even when MOSFET board of the ESC is burnt or breakdown.
- Online firmware upgrade via ALIGN ASBOX Multifunction Programmer or WIFI module.
- 使用運行頻率高達120MHz的高性能微處理器，相容多機無刷馬達，具備優良的定速和緩啟動性能。
- 微處理器採用獨立的穩壓IC供電，具有更好的抗干擾能力，降低失控的可能性。
- 支持馬達最高轉速可達210,000 RPM(2磁馬達)、70,000RPM(6磁馬達)/35,000RPM(12磁馬達)。
- 具有「固定翼模式/直升機線性油門模式/直升機定速模式/直升機存儲定速模式」4種飛行模式。
- 具有飛行資料記錄功能，可記錄每次飛行的最低電壓、最高溫度資料、最大電流、穩定轉速。
- 具有熄火降壓保護功能，在保護時間內可手動中斷熄火降落過程並快速重新啟動馬達，避免失控而撞機。
- 支援WIFI無線設定，透過手機端(蘋果&安卓)軟體可完成所有參數設置(需要WIFI模組)。
- 內置防火花電路，有效消除上電瞬間產生的電火花。
- 具有轉速(RPM)訊號輸出介面。
- 具備獨立參數設定介面，用於連接多功能LCD專業程式設計ALIGN ASBOX多功能設定盒進行參數設定。
- 設計ALIGN ASBOX多功能設定盒進行參數設定。
- 具備啟動保護、溫度保護、過負荷保護、電流保護等多重保護功能，有效防止電機使用過熱。
- BEC模組和電子調速器其他電路相互獨立，當電子調速器功率板出現燒毀等故障時，最大限度保護BEC正常輸出，避免飛機墜毀。
- 支援線上讀取、設定電壓設定時，查看速度曲線表(存儲模式下)，升級電子調速器固件(需要ALIGN ASBOX多功能設定盒或WIFI模組)。

SPECIFICATIONS 產品規格

Model 型號	Main Applications 應用範圍	Input Voltage 輸入電壓	Cont./Peak Current 持續/瞬間電流	BEC Voltage BEC
Hobby Wing Platinum HV 200A	For 700-800 Class Helicopter (Propeller: 700-800mm) 700-800級電動直升機 (槳長: 700-800mm)	6-14S LiPo Battery (22.2V-51.8V) 6-12S 鋰電池 (22.2V-51.8V)	200A/300A	Switch-mode, 5V-8V Adjustable Voltage (Step: 0.1V), 10A/30A Cont./Peak Current 純變壓器BEC, 輸出電壓5V-8V可調(調整幅度為0.1V每步), 輸出電流持續10A, 瞬間30A
	Throttle Signal/BEC Output & RPM Signal Transmission Wire 油門信號/BEC輸出&RPM信號傳輸線		Size/Weight 尺寸/重量	Separate Programming Port 獨立參數程式設計介面
	White/Red/Black: Throttle Signal Wire ; Red/Brown/Yellow: BEC Output & RPM Signal Transmission Wire 白、紅、黑三色線為油門信號線; 紅、棕、黃三色線為BEC輸出及RPM信號傳輸線	106x50x36mm/325g	For connecting ALIGN ASBOX Multifunction Programmer, WiFi module, or cooling fan. 用於連接ALIGN ASBOX多功能設定盒或WiFi模組, 可為輔助散熱風扇供電	

USER GUIDE 使用說明書



The default throttle range of this ESC is from 1100 μ s to 1940 μ s, so you need to re-calibrate the throttle range when the first time you use this ESC or after you replace the transmitter.

電子调速器的油門行程出廠預設值為1100 μ s-1940 μ s, 當首次使用電子调速器或者更換其他遙控器使用時, 均應重新設定油門行程。

I. Connections 接線示意圖

- RPM Signal Wire (Yellow) & BEC Output Wire (Red/Brown):** plug it into the RPM input channel on the flybarless system. (This wire can be used for providing RPM signal data when using external speed-governing device. plug it into the battery channel or any unoccupied channel on the receiver. (For better BEC power supply, we recommend plugging this wire into the battery channel or any unoccupied channel on FBL system if the FBL system is permitted.

- Throttle Signal Wire (White/Red/Black):** plug it into the throttle channel on the receiver or the corresponding channel on the FBL system, such as RX B channel on the VBAR system. For which channel you should plug it in, it depends on what kind of receiver and FBL system you use. The White wire is for transmitting throttle signals, the Red & Black cables are parallelly connected in the BEC output wire, which means BEC voltage output wire and ground cable.

- RPM信號線(黃)及BEC輸出線(紅、棕):** 插入無平衡翼系統轉速輸入通道; (當使用外部定速時, 可使用RPM信號線提供轉速信號輸入, 這條線外的BEC輸出線插入接收機電池專用通道或在真空間通道。(為獲得更好的BEC供電效果, 在無平衡翼系統允許的情況下, 建議將BEC線插入無平衡翼系統的電池專用通道或在真空間通道。)

- 油門信號線(白、紅、黑):** 插入接收機油門通道或無平衡翼系統對應通道, 如VBAR系統的RX B通道, 依接收機類型及無平衡翼系統類型而定。其中白線用於傳送油門信號, 而紅線和黑線分別並聯在內部BEC的輸出端(即BEC電壓輸出線和地線)。

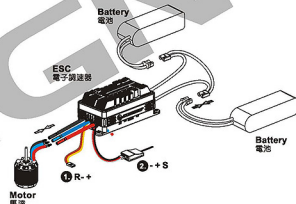

II. Throttle Range Calibration 油門行程校準操作方法



During the ESC/Radio calibration, please set the throttle curve to NORMAL and ensure the corresponding throttle amounts to the maximum throttle endpoint and the minimum throttle endpoint on your transmitter are respectively 100% and 0%.

進行油門行程校準時, 請將油門曲線設置為NORMAL, 並確保遙控器油門最高點對應的油門值為100%, 油門最低點對應的油門值為0%

1. Turn on the transmitter and move the throttle stick to the top position.
開啟遙控器, 將油門打到最高點

2. Connect the ESC to a battery. The motor will emit " >123" indicating the ESC is powered on normally.
電子调速器接電池, 馬達鳴叫">123"提示音, 表示供電正常

3. 5 seconds later, the motor will emit two short beeps indicating the maximum throttle position has been successfully calibrated and accepted.
等待5秒, 馬達發出"嗶-嗶"雙短鳴音, 表示油門最高點校準成功

4. Move the throttle stick to the bottom position. 1 second later, a short beep will emit indicating the minimum throttle position has been accepted.
將油門搖杆推到最低, 等待1秒, "嗶"一聲提示音, 油門最低點校準成功

5. The ESC will keep beeping indicating the number of LiPo cells you have plugged in. (A long beep represents 5, a short beep represents 1. E.g. The ESC will keep two long beeps and two short beeps to indicate a 12S LiPo pack.
馬達將連續鳴叫提示當前電池數(長音嗶一表示5, 短音嗶一表示1, 例如: 12S鋰電池將鳴叫"嗶-嗶-嗶-嗶")

6. The motor will beep a long beep to indicate the calibration is completed, the power system is ready to go.
馬達鳴叫"長音嗶"代表校準成功, 系統準備就緒, 可隨時起飛

PLEASE PRACTICE SIMULATION FLIGHT BEFORE REAL FLYING 飛行前請先熟練電腦模擬飛行











A safe and effective practice method is to use the transmitter flying on the computer through simulator software sold on the market. Do a simulation flight until you familiarize your fingers with the movements of the rudders, and keep practicing until the fingers move naturally.

- Place the helicopter in a clear open field (Make sure the power OFF) and the tail of helicopter point to yourself.
- Practice to operate the throttle stick (as below illustration) and repeat practicing "Throttle high/low", "Aileron left/right", "Rudder left/right", and "Elevator up/down".
- The simulation flight practice is very important, please keep practicing until the fingers move naturally when you hear operation orders being call out.

在這邊瞭解直昇機各動作的操作方式前，嚴禁實際飛行，請先進行電腦模擬飛行的練習，一種最有效、最安全的練習方式，就是透過市面販售的模擬軟體，以遙控器在電腦上模擬飛行，熟悉各種方向的操控，並不斷的重複，直到手指可熟練的控制各個動作及方向。

- 將直昇機放在空曠的地方(確認電源為關閉)，並將直昇機的機尾對準自己。
- 練習操作遙控器的各搖桿(各動作的操作方式如下圖)，並反覆練習油門高/低、副翼左/右、升降舵前/後及方向舵左/右操作方式。
- 模擬飛行的練習相當重要，請重複練習直到不需思索，手指能自然隨著喊出的指令移動控制。



Mode 1	Mode 2	Illustration 圖示
		 <p>Move Left 左移</p> <p>Move Right 右移</p> <p>Rotate Left 左翻</p> <p>Rotate Right 右翻</p>
		 <p>Fly Forward 前進</p> <p>Fly Backward 後退</p> <p>Forward Rotate 前翻</p> <p>Backward Rotate 後翻</p> <p>Ascent 上升</p> <p>Descent 下降</p>
		
		 <p>Turn Right 右旋</p> <p>Turn Left 左旋</p>

FLIGHT ADJUSTMENT AND NOTICE 飛行調整與注意



- Check if the screws are firmly tightened.
- Check if the transmitter and receivers are fully charged.
- 再次確認螺絲是否鎖緊?
- 發射器和接收器電池是否足額。



If there are other radio control aircraft at the field, make sure to check their frequencies and tell them what frequency you are using. Frequency interference can cause your model, or other models to crash and increase the risk of danger. 假使飛行場有其他遙控飛機，請確認他們的頻率，並告知他們您正在使用的頻率，相同的頻率會造成干擾導致失控和大大地增加風險。

STARTING AND STOPPING THE MOTOR 啟動和停止馬達



First check to make sure no one else is operating on the same frequency. Then place the throttle stick at lowest position and turn on the transmitter. 首先確認附近沒有其他相同頻率的機，然後打開發射器將油門搖桿推到底點。

- Check the movement.
- 動作確認



ON! Step1
First turn on the transmitter.
先開啟發射器



ON! Step2
Connect to the helicopter power
接上直昇機電源



Check if the throttle stick is set at the lowest position.
確認油門搖桿是在最低的位置。

- Are the rudders moving according to the controls?
- Follow the transmitter's instruction manual to do a range test.
- 方向舵是否隨著控制方向移動?
- 根據發射器說明書進行距離測試。

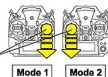

OFF! Step3
Reverse the above orders to turn off.
關閉電源時請逆上述操作動作執行。



This procedure is best performed on soft surfaces such as grass. The use of rubber skid stopper is recommended on hard surface to prevent vibration feedback from the ground to Gyro, resulting in over-corrections.

將直升機置於柔軟地面上，建議硬地起飛腳架裝上避震墊圈。避免升空前腳架與硬變的地面震動太大反饋至機身上的陀螺儀，影響無平衡翼系繞升空前過度修正。

Rubber Skid Stoppers Installed
裝上避震墊圈



If swashplate should tilt prior to lift off, do not try to manually trim the swashplate level. This is due to vibration feedback to the Gyro, and will disappear once helicopter lifts off the ground. If manual trim is applied, helicopter will tilt immediately after lift-off.

直昇機離地前，十字盤可能因陀螺儀受震動的反應，使十字盤有傾斜的情形，此將請勿刻意將十字盤修正為水平狀態，此現象只要離地升空時立即解除，可平穩升空；若刻意將十字盤修正為水平時，反而會造成感應器過度修正，一離地即偏往修正方向的危險。

MAIN ROTOR ADJUSTMENTS 主旋翼雙槳平衡調整

1. Before adjusting, apply a red piece of tape on one blade, or paint a red stripe with a marker or paint to identify on blade.
2. Raise the throttle stick slowly and stop just before the helicopter lifts-off ground. Look at the spinning blades from the side of the helicopter.

3. Look at the path of the rotor carefully. If the two blades rotate in the same path, it does not need to adjustment. If one blade is higher or lower than the other blade, adjust the tracking immediately.

1. 調整前先在其中一支主旋翼的槳端，貼上有顏色的貼紙或畫上顏色記號，方便雙槳調整辨識。
2. 慢慢的推起油門搖桿到高點並且停止，在飛機離地前地面，從飛機側邊觀察主旋翼轉動。
3. 仔細觀察旋翼軌跡(假如兩支旋翼移動都是相同軌跡，則不需要調整;可是如果一支旋翼較高或較低產生「雙槳」的情形時，則必須立刻調整軌跡)。

- a. When rotating, the blade with higher path means the pitch is too big. Please shorten ball link for regular trim.
- b. When rotating, the blade with lower path means the pitch is too small. Please lengthen ball link for regular trim.

- a. 旋翼轉動時較高軌跡的主旋翼表示螺距(PITCH)過大，請調短連桿修正。
- b. 旋翼轉動時較低軌跡的主旋翼表示螺距(PITCH)過小，請調長連桿修正。



Tracking adjustment is very dangerous, so please keep away from the helicopter at a distance of at least 10m.

調整軌跡非常危險，請於距離飛機最少10公尺的距離。

Incorrect tracking may cause vibrations. Please repeat adjusting the tracking to make sure the rotor is correctly aligned. After tracking adjustment, please check the pitch angle is approx. $+5^{\circ}$ ~ -6° when hovering.

不正確的旋翼軌跡會導致震動，請不斷重複調整軌跡，使旋翼軌跡精準正確。

在調整軌跡後，確認一下Pitch角度在停旋時應為大約 $+5^{\circ}$ ~ -6° 。



FLIGHT ADJUSTMENT AND NOTICE 飛行調整與注意



Ⓢ Do not attempt to grab or make contact with the helicopter while the main blades are in motion and keep your eyes away from the helicopter. During take-off, landing, and flight, be sure to keep the helicopter away from all obstacles. Operators must stand at least 10 meters away from the helicopter to avoid injury caused by loose parts due to improper assembly or any unforeseen dangers.

Ⓢ 嚴禁用手抓取運行中的直昇機，並禁止將直昇機對著眼睛。當主旋翼轉動後，或起飛/試飛時，務必遠離障礙物，站立位置必需距離10公尺以上，避免因人為組裝不當造成零件脫落，而引發不可預期的財物及人員損傷。



- Ⓢ Make sure that no one or obstructions in the vicinity.
- Ⓢ For flying safety, please carefully check if every movement and directions are correct when hovering.
- Ⓢ 確認鄰近地區沒有人和障礙物。
- Ⓢ 為了飛行安全，您必須先確認停機時各架操動作是否正確。



Do not attempt to fly until you have some experiences with the operation of helicopter.
嚴禁無熟練操控飛行經驗者操控飛行。

STEP 1 THROTTLE CONTROL PRACTICE 油門控制練習

- ① When the helicopter begins to lift-off the ground, slowly reduce the throttle to bring the helicopter back down. Keep practicing this action until you control the throttle smoothly.

◎當直昇機開始離地時，慢慢降低油門將飛機降下。持續練習飛機從地面上升和下降直到你覺得油門控制很順。

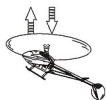
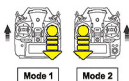

STEP 2 AILERON AND ELEVATOR CONTROL PRACTICE 副翼和升降控制練習

1. Raise the throttle stick slowly.
2. Move the helicopter in any direction back, forward, left and right, slowly move the aileron and elevator sticks in the opposite direction to fly back to its original position.

1. 慢慢升起油門搖桿。
2. 使直昇機依指示：移動向後/向前/向左/向右，慢慢的反向移動副翼和升降搖桿並將直昇機回到原來位置。

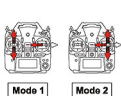

◎If the nose of the helicopter moves, please lower the throttle stick and land the helicopter. Then move your position diagonally behind the helicopter 10M and continue practicing.

◎If the helicopter flies too far away from you, please land the helicopter and move your position behind 10M and continue practicing.

◎當直昇機機頭偏移時，請降低油門並且降落，然後移動自己的位置到直昇機的正後方10公尺再繼續練習。

◎假如直昇機飛離你太遠，請先降落直昇機，並到直昇機後10公尺再繼續練習。

STEP 3 RUDDER CONTROL PRACTICING 方向舵操作練習

1. Slowly raise the throttle stick.
2. Move the nose of the helicopter to right or left, and then slowly move the rudder stick in the opposite direction to fly back to its original position.

1. 慢慢升起油門搖桿。
2. 將直昇機機頭移動左或右，然後慢慢反向移動方向舵搖桿並將直昇機飛回原本位置。

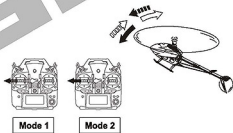

STEP 4

After you are familiar with all actions from STEP1 to 3, draw a circle on the ground and practice within the circle to increase your accuracy.

當你覺得 STEP1-3 動作熟悉了，在地上畫圓圈並在這個圓圈的範圍內練習飛行，以增加你操控的準確度。

◎You can draw a smaller circle when you get more familiar with the actions.

◎當你更加習慣操作動作，你可以畫更小的圓圈。



STEP 5 DIRECTION CHANGE AND HOVERING PRACTICE 改變直昇機方向和練習停旋

After you are familiar with STEP1 to 4, stand at side of the helicopter and continue practicing STEP1 to 4. Then repeat the STEP1 to 4 by standing right in front of the helicopter.

當你覺得STEP1-4動作熟悉了，站在面對直昇機側邊並繼續練習STEP1-4。之後，站在直昇機機頭右邊重複步驟練習。

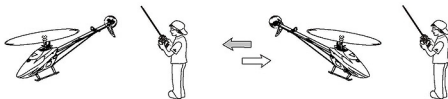

	Problem 狀況	Cause 原因	Solution 對策
Blade Tracking 雙槳平衡	Tracking is Off 雙槳	Pitch linkage rods are not even length PITCH連桿長度調整不平均	Adjust length of Linkage rod A. 調整連桿A長度
Hover 停懸	Head speed too low 主旋翼轉速偏低	Excessive pitch 主旋翼的PITCH偏高	Adjust ball link to reduce pitch by 4 to 5 degrees. Hovering headspeed should be around 1700-1800RPM. 調整連桿頭端低Pitch約+4-5度 (停懸時主旋翼轉速為約1700-1800RPM)
		Hovering throttle curve is too low 停懸點油門曲線過低	Increase throttle curve at hovering point on transmitter (around 60%) 提高停懸點油門曲線(約60%)
	Head speed too high 主旋翼轉速偏高	Not enough pitch 主旋翼的PITCH偏低	Adjust ball link to increase pitch by 4 to 5 degrees. Hovering headspeed should be around 1700-1800RPM. 調整連桿頭端高Pitch約+4-5度 (停懸時主旋翼轉速為約1700-1800RPM)
		Hovering throttle curve is too high 停懸點油門曲線過高	Decrease throttle curve at hovering point on transmitter (around 60%) 降低停懸點油門曲線(約60%)
Rudder Response 尾舵反應	Drifting of tail occurs during hovering, or delay of rudder response when centering rudder stick. 停懸時尾翼向某一邊偏移，或撥動方向舵並回復到中立點時，尾翼產生延遲，無法停頓在所控制位置上。	Rudder neutral point improperly set 尾中立點設定不當	Reset rudder neutral point 重設尾中立點
	Tail oscillates (hunting, or wags) at hover or full throttle 停懸或全油門時尾翼左右來回搖擺。	Rudder gyro gain too low 尾舵陀螺儀敏感度偏低	Increase rudder gyro gain 增加尾舵陀螺儀敏感度
		Rudder gyro gain too high 尾舵陀螺儀敏感度偏高	Reduce rudder gyro gain 降低尾舵陀螺儀敏感度

If above solution does not resolve your issues, please check with experienced pilots or contact your Align dealer.

※在做完以上調整後，仍然無法改善情況時，應立即停止飛行並向有經驗的飛手諮詢或連絡您的經銷商。

ALIGN

Specifications & Equipment/規格配備:

Length/機身長:1320mm

Height/機身高:360mm

Main Blade Length/主旋翼長:700mm

Main Rotor Diameter/主旋翼直徑:1582mm

Tail Rotor Diameter/尾旋翼直徑:281mm

Motor Drive Gear/馬達齒輪:13T

Main Drive Gear/主齒輪:110T

Autorotation Tail Drive Gear/尾驅動主齒:102T

Tail Drive Gear/尾翼傳動齒:23T

Drive Gear Ratio/齒輪傳動比: 8.46:1:4.43

Flying Weight(with batteey)/全配重(含電池): Approx. 5100g

