

# DOMINATOR TREX 550X

## INSTRUCTION MANUAL

### 使用說明書

**ALIGN**

RH55E18XT  
RH55E19XT  
RH55E22XT



Excellent Torque and  
Superior Power

高扭力 全新動力

#### Contents

1	INTRODUCTION 前言
1-2	SAFETY NOTES 安全注意事項
3	EQUIPMENT REQUIRED FOR ASSEMBLY 自備設備
3	PACKAGE ILLUSTRATION 包裝說明
4-5	MODEL STANDARD EQUIPMENT DIFFERENCE 標準配備版本說明
6	SAFETY CHECK BEFORE FLYING 飛行前安全檢查重要事項
7-17	ASSEMBLY SECTION 組裝說明
18	EQUIPMENT INSTALLATION 各項設備配置圖
18	BATTERY INSTALLATION ILLUSTRATION 電池安裝示意圖
20	INSTALLATION FOR ESC 無刷調速器安裝
20	CANOPY ASSEMBLY 機頭罩安裝
21	ELECTRIC EQUIPMENT ILLUSTRATION 電子設備建議配置圖示
21-22	MICROBEAST PLUS FLYBARLESS MANUAL 無平衡翼系統使用說明
23	SERVO SETTING AND ADJUSTMENT 伺服器設定調整
23	ADJUSTMENTS FOR GYRO AND TAIL NEUTRAL SETTING 陀螺儀與尾翼中立點設定調整
24	PITCH AND THROTTLE SETTING 主旋翼螺絲與油門設定
25	POWER COLLOCATION REFERENCE 原裝動力數據參考表
25-26	RCE-BL100A Brushless ESC INSTRUCTION MANUAL RCE-BL100A 無刷調速器使用說明
27-29	FLIGHT ADJUSTMENT AND SETTING 飛行動作調整與設定
30	TROUBLESHOOTING 飛行中狀況排除



**MICROBEAST PLUS**  
6-AXIS MEMS SENSOR SYSTEM FOR RC-MODELS



Thank you for purchasing Align products. Please read the manual carefully before installing and be sure to retain the manual for future reference. All pictures shown are for illustration purpose only. Actual product may vary due to product enhancement. Specifications, contents of parts and availability are subject to change, ALIGN RC is not responsible for inadvertent errors in this publications.

承蒙閣下選用亞拓遙控世界系列產品，謹表謝意。使用前，請務必詳閱本說明書，相信一定能夠給您帶來相當大的幫助，也請您妥善保管這本說明書，以做為日後參考。本公司將不對此印刷物之異動負責，也無法主動通知消費者任何更新或異動。所有圖片僅用於展示目的。產品可能因改良而有些不同。本說明書內記載的材質、規格或零件包裝之內容物如有異動，請依亞拓官網公告為主。

Thank you for buying ALIGN Products. The T-REX 550X Dominator Helicopter is designed as an easy to use, full featured Helicopter R/C model capable of all forms of rotary flight. Please read the manual carefully before assembling the model, and follow all precautions and recommendations located within the manual. Be sure to retain the manual for future reference, routine maintenance, and tuning. The T-REX 550X Dominator is a new product developed by ALIGN. It features the best design available on the Micro-Heli market to date, providing flying stability for beginners, full aerobatic capability for advanced fliers, and unsurpassed reliability for customer support.

感謝您選購亞拓產品，為了讓您容易方便的使用 T-REX 550X Dominator 直昇機、請您詳細的閱讀完這本說明書之後再進行組裝以及操作這台直昇機，同時請您妥善的保存這本說明書，作為日後進行調整以及維修的參考。T-REX 550X Dominator 是由亞拓自行研發的新產品，不論是需求飛行穩定性的初學者或是追求性能的飛行愛好者，T-REX 550X Dominator 將是您最佳的選擇。

### WARNING LABEL LEGEND 標誌代表意義

 FORBIDDEN 禁止	Do not attempt under any circumstances. 在任何禁止的環境下，請勿嘗試操作。
 WARNING 警告	Mishandling due to failure to follow these instructions may result in damage or injury. 因為疏忽這些操作說明，而使用錯誤可能造成財產損失或嚴重傷害。
 CAUTION 注意	Mishandling due to failure to follow these instructions may result in danger. 因為疏忽這些操作說明，而使用錯誤可能造成危險。

### IMPORTANT NOTES 重要聲明

R/C helicopters, including the T-REX 550X Dominator are not toys. R/C helicopter utilize various high-tech products and technologies to provide superior performance. Improper use of this product can result in serious injury or even death. Please read this manual carefully before using and make sure to be conscious of your own personal safety and the safety of others and your environment when operating all ALIGN products. Manufacturer and seller assume no liability for the operation or the use of this product. This product is intended for use only by adults with experience flying remote control helicopters at a legal flying field. After the sale of this product we cannot maintain any control over its operation or usage.

As the user of this product, you are solely responsible for operating it in a manner that does not endanger yourself and others or result in damage to the product or the property of others.

We recommend that you obtain the assistance of an experienced pilot before attempting to fly our products for the first time. A local expert is the best way to properly assemble, setup, and fly your model for the first time. The T-REX 550L Dominator requires a certain degree of skill to operate, and is a consumer item. Any damage or dissatisfaction as a result of accidents or modifications are not covered by any warrantee and cannot be returned for repair or replacement. Please contact our distributors for free technical consultation and parts at discounted rates when you experience problems during operation or maintenance. As Align Corporation Limited has no control over use, setup, final assembly, modification or misuse, no liability shall be assumed nor accepted for any resulting damage or injury. By the act of use, setup or assembly, the user accepts all resulting liability.

T-REX 550X Dominator 遙控直昇機並非玩具，它是結合了許多高科技產品所設計出來的休閒用品，所以商品的使用不當或不熟悉都可能造成嚴重傷害甚至死亡，使用之前請務必詳讀本說明書，勿輕忽並注意自身安全。注意！任何遙控直昇機的使用，製造商和經銷商是無法對使用者於零件使用的損耗異常或組裝不當所發生之意外負任何責任，本產品是提供給有操作過模型直昇機經驗的成人或有相當技術的人員在旁指導於當地合法遙控飛行場飛行，以確保安全無虞下操作使用，產品售出後本公司將不負任何操作和使用控制上的任何性能與安全責任。

做為本產品的使用者，您，是單一對於您自己操作的環境及行為負全部的責任之人。

模型商品屬於高風險技術且為消耗性之商品，如經拆裝使用後，會造成或不情況零件損耗，任何使用情況所造成商品不良或不滿意，將無法於保固條件內更換新品或退貨，如若有使用操作維修問題，本公司全售分公司或代理商將提供技術指導、特價零件供應服務。對使用者的不當使用、設定、組裝、修改、或操作不良所造成的破損或傷害，本公司無法控制及負責。任何使用、設定、組裝、修改、或操作不良所造成的破損、意外或傷害，使用者應承擔全部責任。

### SAFETY NOTES 安全注意事項



- Fly only in safe areas, away from other people. Do not operate R/C aircraft within the vicinity of homes or crowds of people. R/C aircraft are prone to accidents, failures, and crashes due to a variety of reasons including, lack of maintenance, pilot error, and radio interference. Pilots are responsible for their actions and damage or injury occurring during the operation or as a result of R/C aircraft models.
- Prior to every flight, carefully check rotorhead spindle shaft screws and tail blade grip screws, linkage balls and screws, ensure they are firmly secured.
- 遙控模型飛機、直昇機屬高危險性商品，飛行時務必遠離人群，人為組裝不當或機件損壞、電子控制設備不良，以及操控上的不熟練、都有可能導致飛行失控損傷等不可預期的意外，請飛行者務必注意飛行安全，並需了解自負疏忽所造成任何意外之責任。
- 每趟飛行前須仔細檢查，主旋翼夾座螺絲、尾旋翼夾座螺絲，以及機身各部位球頭、螺絲，確實上緊螺絲才能升空飛行。



## LOCATE AN APPROPRIATE LOCATION 遠離障礙物及人群

R/C helicopters fly at high speed, thus posing a certain degree of potential danger. Choose a legal flying field consisting of flat, smooth ground without obstacles. Do not fly near buildings, high voltage cables, or trees to ensure the safety of yourself, others and your model. For the first practice, please choose a legal flying field. Do not fly your model in inclement weather, such as rain, wind, snow or darkness.

模型飛機飛行時具有一定的速度，相對的也潛在著危險性，地點的選擇也相對的重要，請嚴守當地法規取合法遙控飛行場地飛行，務必選擇在適當合法飛機飛行場地，並必須注意周圍有沒有人、高樓、建築的、高壓電線、樹木等等，避免操控的不當造成自己與他人財產的損壞。請勿在下雨、打雷等惡劣天氣下操作，以確保本身及機體的平安。



## NOTE ON LITHIUM POLYMER BATTERIES 鋰聚電池注意事項

Lithium Polymer batteries are significantly more volatile than alkaline or Ni-Cd/Ni-MH batteries used in RC applications. All manufacturer's instructions and warnings must be followed closely. Mishandling of Li-Po batteries can result in fire. Always follow the manufacturer's instructions when disposing of Lithium Polymer batteries.

鋰聚電池跟一般在RC使用的鹼性電池、鎳鎘電池、鎳氫電池比較起來是相對危險的。請嚴格遵守鋰聚電池說明書之使用注意事項，不恰當使用鋰聚電池，可能造成火災並傷及生命財產安全，切勿大意！

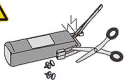

## PREVENT MOISTURE 遠離潮濕環境

R/C models are composed of many precision electrical components. It is critical to keep the model and associated equipment away from moisture and other contaminants. The introduction or exposure to water or moisture in any form can cause the model to malfunction resulting in loss of use, or a crash. Do not operate or expose to rain or moisture.

模型機內部也是由許多精密的電子等組件組成，所以必須絕對的防止潮濕或水氣，避免在浴室或雨天時使用，防止水氣進入機身內部而導致機件及電子零件故障而引發不可預期的意外！



## PROPER OPERATION 勿不當使用本產品

Please use the replacement of parts on the manual to ensure the safety of instructors. This product is for R/C model, so do not use for other purpose.

請勿自行改造加工，任何的升級改造或維修，請使用亞拓產品目錄中的零件，以確保結構的平安。請勿於產品包裝內操作，請勿過載使用，並勿用於安全、法令外其它非法用途。



## OBTAIN THE ASSISTANCE OF AN EXPERIENCED PILOT 避免獨自操控

Before turning on your model and transmitter, check to make sure no one else is operating on the same frequency. Frequency interference can cause your model, or other models to crash. The guidance provided by an experienced pilot will be invaluable for the assembly, tuning, trimming, and actual first flight or unforeseen danger may happen. (Recommend you to practice with computer-based flight simulator.)

在飛行場飛行前，需確認是否有相同頻率的同好者正在飛行，因為開啓相同頻率的發射器將導致自己與他人立即墜等意外危險。遙控飛機操控技巧在學習初期將有一定的難度，更需盡量避免獨自操作飛行，需有經驗的人士在旁指導，才可以操控飛行，否則將可能造成不可預期的意外發生。(勸導電友儘量練習及老手指導是入門必要的選擇)



## SAFE OPERATION 安全操作

Make sure to always be aware to keep your eyes and body away from blades rotation. Do not attempt to grab or make contact with the helicopter while the main blades are in motion. During take-off, landing, and flight, be sure to keep the helicopter away from all obstacles. Operators must stand at least 10 meters away from the helicopter. Never take your eyes off the model or leave it unattended while it is turned on, and immediately turn off the model and transmitter when you have landed the model. Operate this unit within your ability, do not fly under tired condition, improper operation may cause in danger, and always to avoid injury caused by loose parts due to improper assembly or any unforeseen dangers.

請隨時注意，無論在任何時候，都不能將運轉中的旋翼對著眼睛，嚴禁用手抓取運行中的模型機，當主旋翼轉動後，或起飛/降落時，務必遠離障礙物，站立位置必須距離10公尺以上，不可在視線範圍外進行飛行，降落後也請馬上關閉遙控飛機和遙控電器，操作這台模型機需有一定操控技術及能力，避免因人為錯誤不當造成零件脫落，而引發不可預期的財物及人員損傷，並請檢查自身情況，過於疲勞、精神不佳或不當操作，都可能引誘不可預期的意外發生。



## ALWAYS BE AWARE OF THE ROTATING BLADES 遠離運轉中零件

During the operation of the helicopter, the main rotor and tail rotor will be spinning at a high rate of speed. The blades are capable of inflicting serious bodily injury and damage to the environment. Be conscious of your actions, and careful to keep your face, eyes, hands, and loose clothing away from the blades. Always fly the model a safe distance from yourself and others, as well as surrounding objects.

模型機主旋翼與尾旋翼轉動時會以高轉速下進行，在高轉速下的旋翼會造成自己與他人在身體上或環境上的嚴重損傷，請勿靠近運轉中的主旋翼與尾旋翼，並保持安全距離以避免造成危險及損壞。



## KEEP AWAY FROM HEAT 遠離熱源



R/C models are made of various forms of plastic. Plastic is very susceptible to damage or deformation due to extreme heat and cold climate. Make sure not to store the model near any source of heat such as an oven, or heater. It is best to store the model indoors, in a climate-controlled, room temperature environment.

遙控飛機多半是以 PA 纖維或聚乙烷、電子商品為主要材質，因此要盡量遠離熱源、日曬，以避免因高溫而變形甚至熔毀損壞的可能。





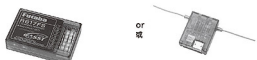







## RADIO TRANSMITTER AND ELECTRONIC EQUIPMENT REQUIRED FOR ASSEMBLY

自備遙控及電子設備



 <p><b>Transmitter</b> (6-channel or more, Helicopter system) 發射器 (六軌以上直升機模式遙控器)</p>	 <p><b>Receiver</b>(6-channel or more) 接收器 (六軌以上)</p> <p>or 或</p> <p><b>Remote Receiver</b> 衛星天線</p>
 <p>22.2V 6S 2600~5200mAh Li-Po Battery x 1 22.2V 6S 2600~5200mAh Li-Po 電池 x 1</p>	 <p><b>Intelligent Balance Charger RCC-6CX</b> 智慧型分壓充電器 RCC-6CX</p> <p>or 或</p> <p><b>RCC-300 Battery Charger</b> RCC-300 充電器</p>

## ADDITIONAL TOOLS REQUIRED FOR ASSEMBLY 自備工具

 <p><b>[H70118]</b> Swashplate Leveler 十字撥校正器</p>	 <p><b>[HET80001]</b> AP800 Digital Pitch Gauge AP800 數位傾距規</p>	 <p><b>[HETMT901]</b> Multi-function Tester 多功能檢測計</p>				
 <p><b>Philips Screw Driver</b> 十字螺絲起子 φ 3.0/φ 1.8mm</p>	 <p><b>Cutter Knife</b> 刀子</p>	 <p><b>Hexagon Screw Driver</b> 六角螺絲起子 4mm/3mm/2.5mm 2mm/1.5mm</p>	 <p><b>Needle Nose Pliers</b> 尖嘴鉗</p>	 <p><b>Oil</b> 潤滑油</p>	 <p><b>CA Glue</b> 瞬間膠</p>	 <p><b>Grease</b> 潤滑油</p>

## PACKAGE ILLUSTRATION 包裝說明

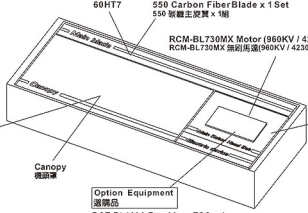

















ALIGN



































 <p>60HT7</p> <p>550 Carbon Fiber Blade x 1 Set 550 碳纖維主翼 x 1組</p> <p>RCM-BL730MX Motor (960KV / 4230) x 1 RCM-BL730MX 無刷馬達(960KV / 4230) x 1</p> <p>Option Equipment 選購品</p> <p>RCE-BL100A Brushless ESC x 1 RCE-BL100A 無刷调速器 x 1</p> <p>Microbeast PLUS Flybarless System x 1 無平衡翼系統 x 1</p> <p>50HC6</p> <p>55FLH</p> <p>55HB9</p> <p>55HB10</p> <p>55HB11</p> <p>60HB6</p> <p>700HG3</p> <p>60HT6</p> <p>55HT</p> <p>55HZ9</p> <p>Canopy 機頭罩</p> <p>Option Equipment 選購品</p> <p>[RH55E18XT] T-REX 550X SUPER COMBO</p> <p>DS830M High Voltage Brushless Servo x 3 DS830M 高壓無刷伺服器 x 3</p> <p>DS835M High Voltage Brushless Servo x 1 DS835M 高壓無刷伺服器 x 1</p> <p>[RH55E19XT] T-REX 550X COMBO</p> <p>DS820 High Voltage Brushless Servo x 3 DS820 高壓無刷伺服器 x 3</p> <p>DS825 High Voltage Brushless Servo x 1 DS825 高壓無刷伺服器 x 1</p>	<p><b>Quick Finder</b> 零件快速碼</p> 
---	--

There are many versions of T-REX 550X Dominator for your choice. The Super Combo includes additional electronics and other equipment. The Instruction Manual will refer to the T-REX 550X Dominator Super Combo. You may purchase any additional items referenced in the instruction manual or any spare parts for other 550X Dominator version by referring to more product information in this manual.

T-REX 550X Dominator 系列商品有多種版本可作為選擇，除標準配備會因您購買的商品版本而有些微不同，在組裝、設定上都是一致的，在此我們以 Super Combo 作為操作範例，您也可依照書面上的商品資訊來增添其他選購商品。



T-REX 550X DOMINATOR SUPER COMBO STANDARD EQUIPMENT			T-REX 550X DOMINATOR SUPER COMBO 標準配備		[RH55E18XT]
 55HC6	 55FLH	 55HB9	 55HB10	 55HB11	
 60HB6	 700HG3	 60HT6	 55HT	 55HZ9	
 Microbeast PLUS Flybarless System x 1 無平頭翼系統 x 1	 60HT7		 550 Carbon Fiber Blade 550 碳纖維主旋翼	 RCE-BL100A Brushless ESC x 1 RCE-BL100A 無刷调速器 x 1	
 DS830M High Voltage Brushless Servo x 3 DS830M 高電壓無刷伺服器 x 3	 DS835M High Voltage Brushless Servo x 1 DS835M 高電壓無刷伺服器 x 1	 RCM-BL730MX Motor (960KV / 4230) x 1 RCM-BL730MX 無刷馬達 x 1		 M4x4 止逆螺絲 x 1  Motor Pinion Helical Gear 16T x 1 高速斜齒輪 16T x 1	

T-REX 550X DOMINATOR COMBO STANDARD EQUIPMENT			T-REX 550X DOMINATOR COMBO 標準配備		[RH55E19XT]
					
55HC6	55FLH	55HB9	55HB10	55HB11	
					
60HB6	700HG3	60HT6	55HT	55HZ9	
					
Microbeast PLUS Flybarless System x 1 無平翼系統 x 1	60HT7	550 Carbon Fiber Blade 550 碳纖維主翼	RCE-BL100A Brushless ESC x 1 RCE-BL100A 無刷调速器 x 1		
					
DS820 High Voltage Brushless Servo x 3 DS820 高電壓無刷伺服器 x 3	DS825 High Voltage Brushless Servo x 1 DS825 高電壓無刷伺服器 x 1	RCM-BL730MX Motor (960KV / 4230) x 1 RCM-BL730MX 無刷馬達 x 1	M4x4 Set Screw x 1 M4x4 止咬螺絲 x 1	Motor Pinion Helical Gear 16T x 1 馬達斜齒輪 16T x 1	
T-REX 550X DOMINATOR KIT STANDARD EQUIPMENT			T-REX 550X DOMINATOR KIT 標準配備		[RH55E22XT]
					
55HC6	55FLH	55HB9	55HB10	55HB11	
					
60HB6	700HG3	60HT6	55HT	55HZ9	
					
60HT7	550 Carbon Fiber Blade 550 碳纖維主翼	RCM-BL730MX Motor (960KV / 4230) x 1 RCM-BL730MX 無刷馬達 x 1	M4x4 Set Screw x 1 M4x4 止咬螺絲 x 1	Motor Pinion Helical Gear 16T x 1 馬達斜齒輪 16T x 1	

## CAREFULLY INSPECT BEFORE REAL FLIGHT 請嚴格執行飛行前之檢查義務

- Before flying, please check to make sure no one else is operating on the same frequency for the safety.
- Before flight, please check if the batteries of transmitter and receiver are enough for the flight.
- Before turn on the transmitter, please check if the throttle stick is in the lowest position. IDLE switch is OFF.
- When turn off the unit, please follow the power on/off procedure. Power ON- Please turn on the transmitter first, and then turn on receiver. Power OFF- Please turn off the receiver first and then turn off the transmitter. Improper procedure may cause out of control, so please to have this correct habit.
- Before operation, check every movement is smooth and directions are correct. Carefully inspect servos for interference and broken gear.
- Check for missing or loose screws and nuts. See if there is any cracked and incomplete assembly of parts. Carefully check main rotor blades and rotor holders. Broken and premature failures of parts possibly cause a dangerous situation.
- Check all ball links to avoid excess play and replace as needed. Failure to do so will result in poor flight stability.
- Check if the battery and power plug are fastened. Vibration and violent flight may cause the plug loose and result in out of control.
- 每次飛行前應先確認所使用的頻率是否會干擾他人，以確保自身與他人的安全。
- 每次飛行前應先確認發射器與接收器電池的電量是在足夠飛行的狀態。
- 開機前確認油門搖桿是否位於最低點，熄火降落到關，定速開關 (IDLE) 是否於關閉位置。
- 開機時必須遵守電源開機的程序，開機時應先開啟發射器後，再開啟接收器電源；關機時應先關閉接收器後，再關閉發射器電源。不正確的開關程序可能會造成失控的現象，影響自身與他人的安全，請養成正確的習慣。
- 開機前請先確定直昇機的各個動作是否順暢，及方向是否正確，並檢查伺服器的動作是否有干涉或磨損的情形，使用故障的伺服器將導致不可預期的危險。
- 飛行前確認沒有缺少或鬆脫的螺絲與螺帽，確認沒有組裝不完整或損毀的零件，仔細檢查主旋翼是否有損壞，特別是接近主旋翼夾座的部位。損壞或組裝不完整的零件不僅影響飛行，更會造成不可預期的危險。注意：每次飛行前的安全檢查、保養、及更換損耗零件，請確實嚴格執行以確保安全。
- 檢查所有的選擇頭是否有鬆脫的情形，過鬆的選擇頭應先更新，否則將造成直昇機無法操控的危險。
- 確認電池及電源接頭是否固定牢靠，飛行中的震動或激烈的飛行，可能造成電源接頭鬆脫而造成失控的危險。

When you see the marks as below, please use relative glue or grease to ensure flying safety.

標有以下符號之組裝步驟，請配合上膠或上油，以確保鎖緊零件使用之可靠度。



- CA : Apply small amount of CA Glue to fix. 瞬時膠：使用適量瞬時膠固定
- R48 : Apply small amount of Anaerobic Retainer to fix. 缺氧膠：使用適量缺氧膠固定
- T43 : Apply small amount of Thread Lock to fix. 螺絲膠：使用適量螺絲膠
- OIL : Add small amount of OIL. 潤滑油：添加適量潤滑油
- Grease : Add small amount of Grease. 潤滑油：添加適量潤滑油

When assembling ball links, make sure the "A" character faces outside.

各項膠膠製連桿頭扣接時，"A"字請朝外。



Keep plastic parts away from heat.  
塑膠件避免接近熱源。



CA Glue  
瞬時膠



Anaerobic Retainer  
缺氧膠



Thread Lock  
螺絲膠



Grease  
潤滑油



Oil  
潤滑油

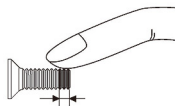

T43 Glue width : approx. 1mm  
T43上膠寬度約 1mm

1. Anaerobic Retainer (R48) is green penetrating threadlocker and is used to fix the metal tube before assembly at temperatures up to +180°C.
2. Thread Lock (T43) is blue low strength threadlocker and is applied to the small screw (threads) or metal parts before assembly to prevent loosening. Ensure to apply only a small amount and wipe surplus off. When disassembling, recommend to heat the metal joint about 15 Seconds.
3. Grease is kind of lubricant additive which is applied to the one-way bearings or thrust bearing.

◎Based on parts physical attributes, please apply small amount of the relative glue or grease accordingly to prevent any parts damage or loosening or unexpected danger happened.

1. 缺氧膠 (R48) 為綠色高強度快速固化的缺氧膠，適合於金屬管狀固定用，可耐高溫至 180°C。
2. 螺絲膠 (T43) 為藍色低強度螺絲膠，適合小型螺絲；使用於金屬內外徑或膠合螺絲時，請務必適量使用，必要時請用手去除去多餘膠量，欲拆卸時可於金屬接合部位熱約 15 秒。
3. 潤滑油 (Grease) 為膏狀潤滑油，適用於單向軸承或止推軸承。

◎上述各類功能膠(油)請依零件屬性需求自行準備並斟酌其用量，以達到最佳組裝狀態，避免因使用不當造成零件損壞或不可預期的意外發生。





Apply a small amount of T43 thread lock when fixing a metal part.  
螺絲鎖附於金屬件時使用適量T43(螺絲膠)。



Already assembled by Factory. Before flying, please check if the screws are fixed with glue.  
原裝組裝完成品，每一次飛行前請先確認螺絲是否已上膠不會鬆動。

### 55FLH7



Bearing  
軸承(φ3xφ7x3mm) x 4



Washer  
墊圈(φ3xφ4.8x0.3mm) x 2



Bearing  
軸承(φ2xφ5x2.3mm) x 4



Collar  
彈簧軸承套(φ3xφ4.8x1.5mm) x 2

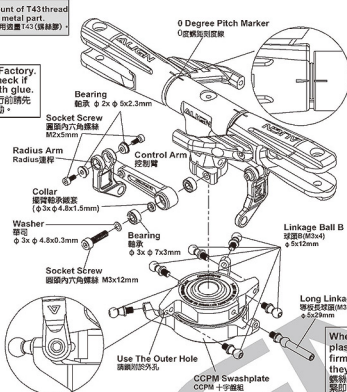

### 55FLH6



Linkage Ball B(M3x4)  
球頭B(M3x4)(φ5x12mm) x 6

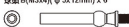

Long Linkage Ball (M3x4)  
導長球頭(M3x4)(φ5x28mm) x 1

### 55FLH7A



Socket screw  
圓頭內六角螺絲(M2x5mm) x 4



Socket Screw  
圓頭內六角螺絲(M3x12mm) x 2

When tightening a screw to a plastic part, please tighten it firmly, but not over tightened, or they will strip.  
螺絲鎖入塑膠件時務必注意，適當扭力鎖緊即可，而過緊的扭力可能會導致滑牙。

### 55FLH7A



M3 Nut  
M3 防鬆螺帽 x 2

Linkage Ball B(M3x4)  
球頭B(M3x4)(φ5x10.5mm) x 2



Socket Collar Screw  
圓頭內六角軸套螺絲(M3x19mm) x 2

### 55FLH7



Linkage Rod(A)  
連桿A(M3x41mm) x 2



Elevator Ball Link  
升降臂連桿頭 x 4

Collar  
連桿套 x 4



Linkage Rod(A)  
Approx. 57.5mm x 2  
連桿(A)約57.5mm x 2

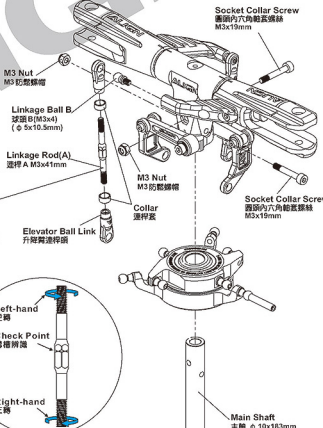

You may adjust the length of ball link when tracking is off while flight.  
若飛行中有變態情形，可適當調整連桿長度改善。



For installation, make sure the "Check Point" is face upward, then use plier or wrench grasp the center of hexagonal rod to adjust its suitable length, turns clockwise to decrease the length, turns counter clockwise to increase the linkage length.

組裝時請將連桿中間有溝槽標高朝上。請使用尖嘴鉗或扳手將連桿中間六角形部位調整適當長度，旋轉時轉動為縮短連桿長度，逆旋轉時轉動為調長連桿長度。



Already assembled by Factory. Before flying, please check if the screws are fixed with glue.  
原裝組裝完成品，每一次飛行前請先確認螺絲是否已上膠不會鬆動。

## 55HB10



Socket Collar Screw  
圓頭內六角筒蓋螺絲 (M3x8mm) x 4



Socket Collar Screw  
圓頭內六角筒蓋螺絲 (M3x6mm) x 16



Socket Screw  
圓頭內六角螺絲 (M3x8mm) x 2



Canopy Mounting Bolt  
機頭罩固定柱  
M3x6.8x18mm x 4

Socket Button Head Screw  
半圓頭內六角螺絲 (M3x8mm) x 2

## 55HZ8



Socket Screw  
圓頭內六角螺絲 (M4x10mm) x 4



M4 Washer  
M4 墊圈 (φ 4x φ 8x1mm) x 4



M4 Set Screw  
M4 止鎖螺絲 (M4x4mm) x 2



CAUTION  
注意

Make sure the motor mount is fully fastened before fasten the motor pinion gear mount.  
先將馬達的固定座鎖緊固定後，再將馬達齒座鎖緊。

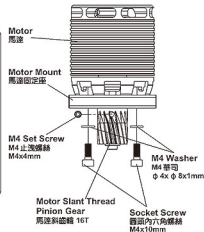

Motor  
馬達

Motor Mount  
馬達固定座

M4 Set Screw  
M4 止鎖螺絲  
M4x4mm

Motor Slant Thread  
Pinion Gear  
馬達斜齒輪 16T

M4 Washer  
M4 墊圈  
φ 4x φ 8x1mm

Socket Screw  
圓頭內六角螺絲  
M4x10mm

Apply a small amount of T43 thread lock when fixing a metal part.  
鎖絲鎖附於金屬件時請使用適量T43 (鎖絲膠)。



CAUTION  
注意

Original manufactory packages contains product already assembled, please confirm every screw is firmly secured with T43. Do not use T43 on any plastic part.

原裝零件出廠包裝如果是組裝品，請需再確認各螺絲是否鎖緊上膠。請注意 T43 不可塗在任何的塑膠材質上。

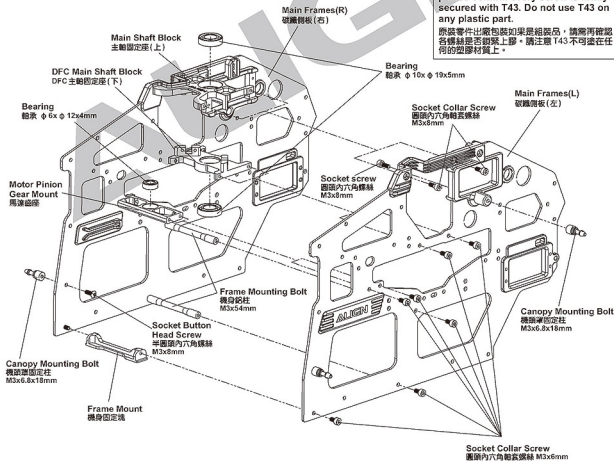

Main Frames(R)  
破機板(右)

Main Shaft Block  
主軸固定座(上)

DFC Main Shaft Block  
DFC 主軸固定座(下)

Bearing  
軸承 φ 6x φ 12x4mm

Bearing  
軸承 φ 10x φ 19x5mm

Motor Pinion  
Gear Mount  
馬達齒輪

Socket Collar Screw  
圓頭內六角筒蓋螺絲  
M3x8mm

Main Frames(L)  
破機板(左)

Socket screw  
圓頭內六角螺絲  
M3x8mm

Frame Mounting Bolt  
機身螺栓  
M3x54mm

Socket Button  
Head Screw  
半圓頭內六角螺絲  
M3x8mm

Canopy Mounting Bolt  
機頭罩固定柱  
M3x6.8x18mm

Canopy Mounting Bolt  
機頭罩固定柱  
M3x6.8x18mm

Frame Mount  
機身固定塊

Socket Collar Screw  
圓頭內六角筒蓋螺絲 M3x6mm



### Main frame assembly key point :

First do not fully tighten the screws of main frames and put two bearings through the main shaft to check if the movements are smooth. The bottom bracket must be firmly touched the level table top(glass surface) ; please keep the smooth movements on main shaft and level bottom bracket, then slowly tighten the screws. This assembly can help for the power and flight performance.

### 機身側板組立重點：

側板螺絲先不完全鎖緊，放入主軸貫穿兩顆軸承觀察上下移動是否滑順，主體基板必須與水平桌面（玻璃平面）踏實緊貼；請保持主軸滑順與底座平行桌面後慢慢鎖緊螺絲，正確輕板的組裝對動力與飛行性能有顯著幫助。

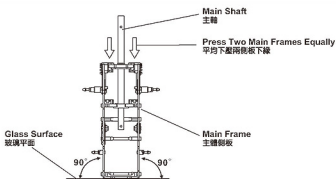

### 55HG2



M3 Washer  
M3 華司 (φ 3x φ 8x1mm) x 4

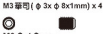

M3 Set Screw  
M3 止鎖螺絲 (M3x4mm) x 4



Socket Screw  
圓頭內六角螺絲 (M3x12mm) x 4

### 55HB11



Socket Button Head Self Tapping Screw  
半圓頭內六角自攻螺絲 (T3x8mm) x 2



Socket Button Head Self Tapping Screw  
半圓頭內六角自攻螺絲 (T3x12mm) x 8

### 55HB10A

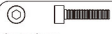

Socket Screw  
圓頭內六角螺絲 (M3x14mm) x 2

### 55HB10

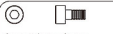

Socket Collar Screw  
圓頭內六角輪蓋螺絲 (M3x6mm) x 4

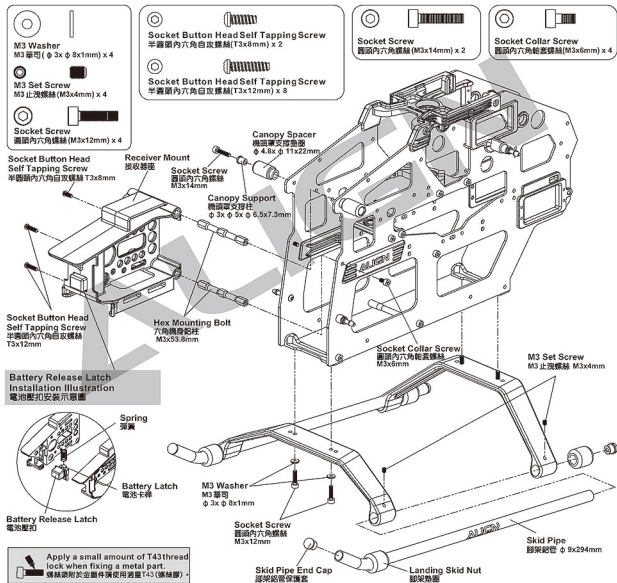

Apply a small amount of T43 thread lock when fixing a metal part.  
鎖絲鎖附於金屬件請使用適量 T43 (鎖絲膠)。

### PROGRESSIVE LIGHTWEIGHT LANDING SKID

前衛新型前傾輕量化設計的腳架

Landing skid is tilted 5 degree forward which improves crashworthiness.

新型腳架減輕耐撞擊，為前傾 5 度前衛設計。



## 55HZ11



Linkage Ball C  
球頭 C(M2.5x3.5) (φ 5x8.5mm) x 1

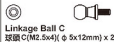

Linkage Ball C  
球頭 C(M2.5x4) (φ 5x12mm) x 2



Socket Button Head Self Tapping Screw  
半圓頭內六角自攻螺絲 (T2.6x12mm) x 4

## 55HZ11



Socket Button Head Screw  
半圓頭內六角螺絲 (M2.5x10mm) x 8



Original manufacturer packages contains product already assembled, please confirm every screw is firmly secured with T43. Do not use T43 on any plastic part.

原廠零件出廠包裝如果是組裝品，請再確認各螺絲是否鎖緊上膠。請注意 T43 不可塗在任何的塑膠材質上。

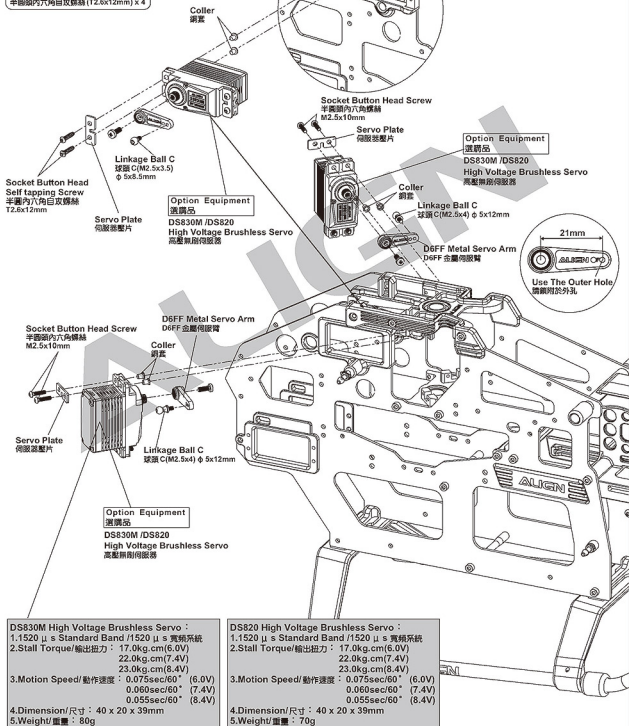

Socket Button Head Self tapping Screw  
半圓頭內六角自攻螺絲  
T2.6x12mm

Servo Plate  
伺服器墊片

Option Equipment  
選購品  
DS830M /DS820  
High Voltage Brushless Servo  
高壓無刷伺服器

D6FF Metal Servo Arm  
D6FF 金屬伺服器臂

Socket Button Head Screw  
半圓頭內六角螺絲  
M2.5x10mm

Servo Plate  
伺服器墊片

Option Equipment  
選購品  
DS830M /DS820  
High Voltage Brushless Servo  
高壓無刷伺服器

Collar  
鎖套

Linkage Ball C  
球頭 C(M2.5x4) φ 5x12mm

D6FF Metal Servo Arm  
D6FF 金屬伺服器臂



Socket Button Head Screw  
半圓頭內六角螺絲  
M2.5x10mm

Collar  
鎖套

Linkage Ball C  
球頭 C(M2.5x4) φ 5x12mm

Servo Plate  
伺服器墊片

Option Equipment  
選購品  
DS830M /DS820  
High Voltage Brushless Servo  
高壓無刷伺服器

DS830M High Voltage Brushless Servo :  
1.1520 μ s Standard Band /1520 μ s 寬頻系統  
2.Stall Torque/輸出扭力: 17.0kg.cm(6.0V)  
22.0kg.cm(7.4V)  
23.0kg.cm(8.4V)  
3.Motion Speed/動作速度: 0.075sec/60° (6.0V)  
0.060sec/60° (7.4V)  
0.055sec/60° (8.4V)  
4.Dimension/尺寸: 40 x 20 x 39mm  
5.Weight/重量: 80g

DS820 High Voltage Brushless Servo :  
1.1520 μ s Standard Band /1520 μ s 寬頻系統  
2.Stall Torque/輸出扭力: 17.0kg.cm(6.0V)  
22.0kg.cm(7.4V)  
23.0kg.cm(8.4V)  
3.Motion Speed/動作速度: 0.075sec/60° (6.0V)  
0.060sec/60° (7.4V)  
0.055sec/60° (8.4V)  
4.Dimension/尺寸: 40 x 20 x 39mm  
5.Weight/重量: 70g

Recommend sanding the marked position as below illustration with waterproof abrasive paper(#800-1000) to avoid the wires of electric parts to be cut.  
建議於下圖色塊標示處，使用#800-1000水砂紙打磨，可防止電子設備電線被刮破。

Apply a small amount of T43 thread lock when fixing a metal part.  
螺絲鎖附於金屬件時使用適量T43(鎖絲膠)。

### 55HZ11

Linkage Ball A(M2x3.5)  
球頭 A(M2x3.5) (φ 4.75x6.18mm) x 1

M2 Nut  
M2 螺帽 x 1

Socket Button Head Self Tapping Screw  
半圓頭內六角自攻螺絲 (T2.6x12mm) x 4

### 55HB10

Socket Collar Screw  
圓頭內六角鉸套螺絲(M3x6mm) x 4

CAUTION  
注意

Original manufactory packages contains product already assembled, please confirm every screw is firmly secured with T43. Do not use T43 on any plastic part.

原廠零件包裝如果是組裝品，請確認每顆螺絲是否鎖緊上膠。

CAUTION  
注意

Make sure the motor mount is fully fastened before fasten the motor pinion gear mount.  
先將馬達固定座鎖緊固定後，再將馬達齒座鎖緊。

While assembling the motor mount, please make sure to properly loose M4 Set screw on 16T motor gear first, after fully fastern the motor mount with the motor pinion, then fastern back the M4 Set screw completely.

安裝馬達座時，請先將 16T 馬達齒座上的 M4x4mm 止洩螺絲逆旋放鬆，當馬達固定座和馬達齒座固定鎖好後，再將馬達止洩螺絲鎖緊。

Motor  
馬達

Motor Mount  
馬達固定座

Servo Extension Cable  
伺服延長線  
120mm

For Extend The Rudder Servo Singal Cable.  
尾端伸縮器訊號線使用

Coller  
鎖套

Servo Plate  
伺服器墊片

M2 Nut  
M2 螺帽

Linkage Ball A(M2x3.5)  
球頭 A(M2x3.5) (φ 4.75x6.18mm)

Option Equipment  
選購品

DS835M/DS825  
High Voltage Brushless Servo  
高壓無刷伺服器

Option Equipment  
選購品

DS835M High Voltage Brushless Servo :  
1.1520 μs Standard Band / 1520 μs 寬頻系統  
2. Stall Torque/輸出扭力 : 8.0kg.cm(6.0V)  
10.0kg.cm(7.4V)  
12.5kg.cm(8.4V)  
3. Motion Speed/動作速度 : 0.04sec/60° (6.0V)  
0.03sec/60° (7.4V)  
0.028sec/60° (8.4V)  
4. Dimension/尺寸 : 40 x 20 x 39mm  
5. Weight/重量 : 72g

DS825 High Voltage Brushless Servo :  
1.1520 μs Standard Band / 1520 μs 寬頻系統  
2. Stall Torque/輸出扭力 : 8.0kg.cm(6.0V)  
10.0kg.cm(7.4V)  
12.5kg.cm(8.4V)  
3. Motion Speed/動作速度 : 0.04sec/60° (6.0V)  
0.03sec/60° (7.4V)  
0.028sec/60° (8.4V)  
4. Dimension/尺寸 : 40 x 20 x 39mm  
5. Weight/重量 : 62g

Socket Collar Screw  
圓頭內六角鉸套螺絲 (M3x6mm)

CAUTION  
注意

Use the second hole from the end of servo horn when attaching ball. Remove the servo horn arms which are not used as pictured below.  
請先將附十字舵角片切除多餘的角三邊，並將球頭鎖附於外側第二孔



Front Drive  
Gear Assembly  
尾扇齒輪軸組



Bearing  
軸承  
φ4xφ9x4mm

Socket Button Head Self  
Tapping Screw  
半圓頭內六角攻螺絲  
T2x3mm

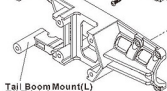

Tail BoomMount(L)  
尾扇固定座(左)

Tail BoomMount(R)  
尾扇固定座(右)

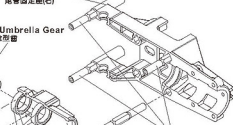

Front Umbrella Gear  
前傳長傘形齒

Bearing  
軸承  
φ12xφ18x4mm

Umbrella Gear Case(R)  
傘殼右固定座

Umbrella Gear Case(L)  
傘殼左固定座

Hex Mounting Bolt  
六角螺栓

Apply a small amount of T43 thread  
lock when fixing a metal part.  
螺絲鎖附於金屬件時使用適量T43(螺絲膠)。

When tightening a screw to a plastic  
part, please tighten it firmly, but not  
over tightened, or they will strip.  
鎖緊鎖入塑膠件時務必注意，適當扭力鎖緊即可，而過緊的扭力可能會導致滑牙。

CAUTION  
注意

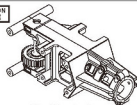

Already assembled by Factory.  
Before flying, please check again if  
screws are firmly secured and  
applied with some glue.  
原裝組裝完成品，請再次確認各螺絲是否鎖緊上膠。

60HT1

CAUTION  
注意

Original manufacturer packages contains product  
already assembled, please confirm every screw is  
firmly secured with T43. Do not use T43 on any plastic  
part.

原裝零件出廠包裝如果是組裝品，請再次確認各螺絲是否鎖緊上膠。



Socket Button Head Self  
Tapping Screw  
半圓頭內六角攻螺絲(T2x3mm) x 2

Bearing  
軸承 φ4xφ9x4mm x 2

Bearing  
軸承 φ12xφ18x4mm x 2

60HT6



Socket Screw  
圓頭內六角螺絲(M3x20mm) x 1

Socket Screw  
圓頭內六角螺絲(M3x6mm) x 4

Bearing  
軸承 φ5xφ10x4mm x 2

Bearing  
軸承 φ12xφ18x4mm x 2

Tail Umbrella Gear  
尾扇齒輪套 φ12.4x18x10mm x 1

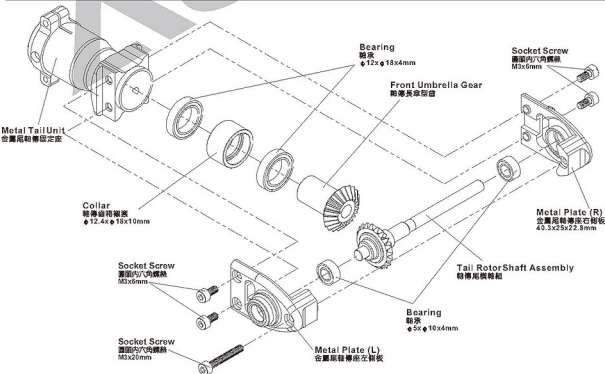

Metal Tail Unit  
金屬尾扇固定座

Collar  
輪傳齒輪襯套  
φ12.4xφ18x10mm

Socket Screw  
圓頭內六角螺絲  
M3x6mm

Socket Screw  
圓頭內六角螺絲  
M3x20mm

Metal Plate (L)  
金屬尾扇傳座左襯板

Bearing  
軸承  
φ12xφ18x4mm

Front Umbrella Gear  
前傳長傘形齒

Socket Screw  
圓頭內六角螺絲  
M3x6mm

Metal Plate (R)  
金屬尾扇傳座右襯板  
40.5x35x22.8mm

Tail Rotor Shaft Assembly  
尾傳尾旋軸組

Bearing  
軸承  
φ5xφ10x4mm

## 60HT6

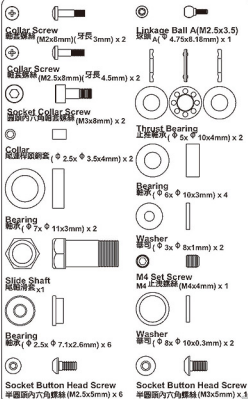

### CAUTION 注意

Make sure to tighten the screws on each side with average strength, but no unilaterally tighten, or it may cause interference during rotation.

組裝螺絲控制組時，上、下螺絲必須平均力度鎖緊，不可單邊過緊，否則會造成干涉滑動不順暢。

Assembling Umbrella Gear: Please note to push the gear to the end at a fixed position, to make sure the gears mesh with each other smoothly.  
傘齒組裝：注意務必前推到底定位，以免齒咬合不順暢。

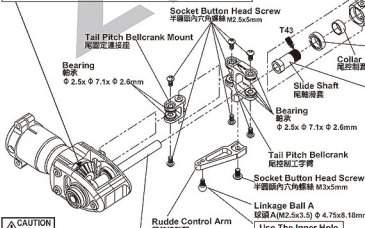

### CAUTION 注意

Aim tail rotor hub at the concave of the tail rotor shaft and apply thread lock on the set screw. The tail rotor hub and screws are wear items, and thus should be inspected for replacement after every 100 flights. For flights with high head speed, the inspection interval should be reduced to ensure flight safety.

尾旋翼 T 型控制臂與尾輪軸的凹面並緊上，請鎖上止咬螺絲上。尾旋翼 T 型控制螺絲屬於飛行消耗品，建議每 100 穩定降落後及更換，高頭速旋翼飛行時，請縮短定期檢查之週數，以確保飛行安全。

### CAUTION 注意

Please tighten M2x8mm collar screw firmly but not over tightened. Over tighten the screw will cause the operation of control link to be tight.  
鎖附 M2x8mm 舵套螺絲時請鎖緊適力過強，過緊則會造成尾舵控制連桿旋轉不順。

## 60HT6A

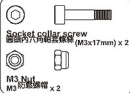

### CAUTION 注意

The Metal Tail Rotor Holder is assembled at the factory, make sure to apply little thread lock on screws and tighten them back appropriately before starting to fly. Suggest to use torque wrench or torque lock for tightening screws with the torque value 5.0kg.cm.

尾旋翼夾座出廠為假組裝，螺絲必須使用適量螺絲膠塗到螺絲，起飛前請注意重新塗膠即可。建議請配扭力或扭力鎖頭，扭力值為 5.0kg.cm。

Apply Grease on Thrust Bearing.  
尾推軸承塗油

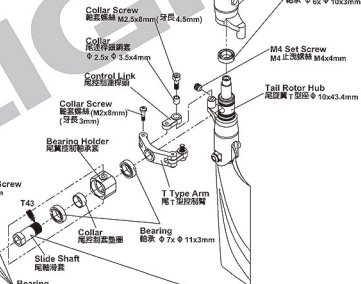

Apply a small amount of T43 thread lock when fixing a metal part.  
螺絲鎖附於金屬件時請使用適量 T43 (螺絲膠)。

While assembly the slide shaft, please use suitable amount of T43 on the thread. Please do not use R48 or other high strength thread lock to avoid damages while maintenance or repairs.  
組立尾輪滑套時，請使用適量的 T43 螺絲膠在螺絲上，嚴禁使用 R48 高強度合性軸承膠防止膠合過緊，以免日後拆修損壞零件之虞。

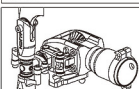

### CAUTION 注意

After complete the tail rotor assembly, please check if it rotates smoothly.  
尾旋翼組裝完成後需確認尾旋翼夾座旋轉動靜。

Already assembled by factory, please note to check again.  
已組裝完成，請務必自行再確認。

When assembling into the tail boom, please apply some oil on the surface, to make it smooth during the assembling and keep it vertical with the torque tube for smooth rotation.  
插入尾管內時，外表抹些潤滑油，以確保平滑裝入尾管中並與尾傳動軸保持垂直，讓尾輪轉動順暢。

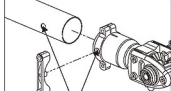

When assembling the tail boom, please aim at the fixing hole  $\phi 5.1$  裝入尾管時請注意孔到準標記 $\phi 5.1$  固定孔

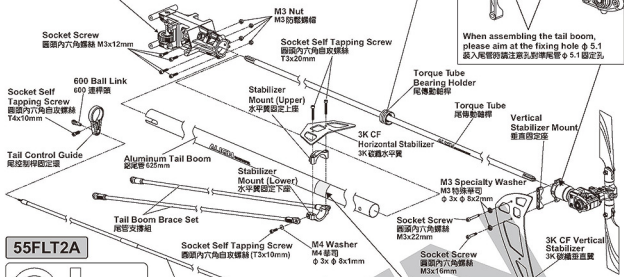

Before assembling, please wrap the tail boom with a scotch tape (Thickness 0.03-0.05mm) to avoid the mount slipping.  
安裝前請先用透明膠帶(0.03-0.05mm厚)包裹尾管，可防止固定座滑動。

### 55FLT2A



### 60HT1A



### 60HT6



### 55HT3A



### TIP TO FIX THE TORQUE TUBE 傳動軸軸承固定位置

Please apply some CA glue to fix bearing on the torque tube, avoid CA glue from the bearing side or may cause the bearing stuck. When assembling into the tail boom, please apply some oil and use the attached torque tube mount helper to press the bearing holder of the torque tube into the tail boom horizontally.

請以少量 CA 將軸承固定於尾傳動軸上，避免 CA 沾到軸承的防塵蓋而導致軸承卡死，插入尾管內時，尾傳動軸承應塗外表抹些潤滑油，利用附贈軸承安裝套裝套將尾傳動軸承壓平插入尾管中不可歪斜。

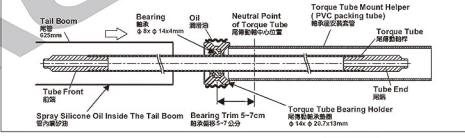

CAUTION 注意

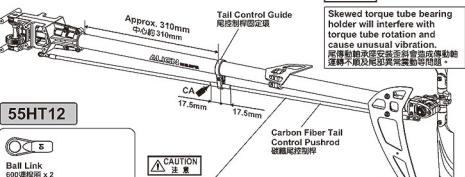

Skewed torque tube bearing holder will interfere with torque tube rotation and cause unusual vibration.  
尾傳動軸承安裝歪斜會造成傳動軸旋轉不順及異常震動等問題。

CAUTION 注意

After moving the tail control rod adjustment sleeve to recommended position, glue the sleeve to carbon tail control rod with instant glue.  
尾控制桿固定環調整至建議位置後，再將尾控制桿固定環與碳纖維尾桿接觸面以瞬間膠固定。



Apply a small amount of T43 thread lock when fixing a metal part.  
螺絲鎖附於金屬件請使用適量 T43 (螺絲膠)

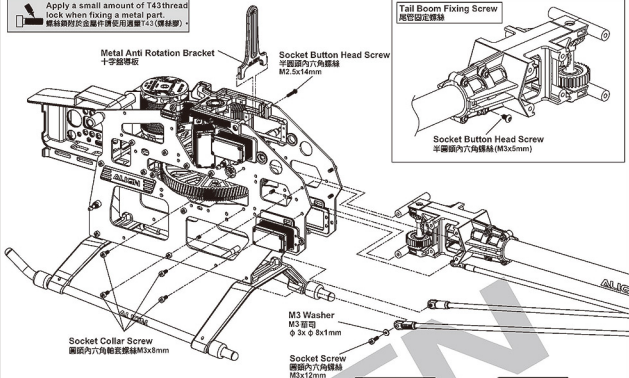

**CAUTION**  
注意

Original factory packages contains product already assembled, please confirm every screw is firmly secured with T43. Do not use T43 on any plastic part.

原裝零件出廠包裝如果是組裝品，請電商確認各螺絲是否鎖緊上膠。請注意 T43 不可塗在任何的塑膠材質上。

**55HB10A**



**55HB10**



**55HT15**

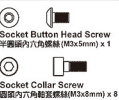

**60HB6**

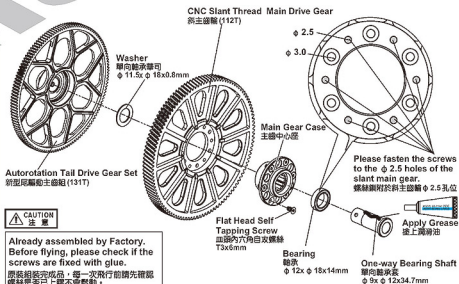

**CAUTION**  
注意

Already assembled by Factory. Before flying, please check if the screws are fixed with glue.  
原裝組裝完成品，每一次飛行前請先確認螺絲是否已上膠不會鬆動。

Before tightening the screw, please rotate the bearing and check the concentricity of the bearing in order to have the screw firmly secured, to avoid the bearing stuck or heavy load at one side and cause slip.

上緊螺絲前請旋轉軸承觀察同心度良好後，才能將螺絲平均鎖緊，以避免造成卡死或單向重負載可能產生的打滑。

Apply a small amount of T43 thread lock when fixing a metal part.  
 裝具時於金屬件請使用適量 T43 (螺絲膠)。

**CAUTION**  
 注意

Original manufacturer packages contains product already assembled, please confirm every screw is firmly secured with T43. Do not use T43 on any plastic part.

原裝零件出廠包裝如果是組裝品，請再確認各螺絲是否鎖緊上膠。請注意 T43 不可塗在任何的塑膠材質上。

When tightening the main blade fixing screw, please tighten it firmly, but not over tighten, or it may cause the damage of main blade holder and result in danger.

鎖緊主旋翼螺絲時注意適量鎖緊即可，過緊可能導致主旋翼夾座受損，飛行意外發生。

## 55FLH7A

Main Blade Fixing Screw

鎖主旋翼用螺絲

Socket Collar Screw

圓頭內六角鉸套螺絲 (M4x25mm) x 2

M4 Nut

M4 防鬆螺帽 x 2

## 700FLZ7

Elevator Ball Link

升降桿連彈簧 x 6

Collar

連桿套 x 6

Linkage Rod(A)

連桿 A (M3x41mm) x 2

[H70118]

Swashplate Leveler

十字盤校正器

Optional Equipment

另購品

Main shaft

主軸

Horizontally Level

水平

Swashplate

十字盤

**CAUTION**  
 注意

While using Flybarless system, please use the swashplate leveler to calibrate swashplate. Adjust the length of servo linkage rod to make sure the swashplate is leveled before start setting up to ensure the gyro provides the best performance.

使用無平衡系統，請務必使用十字盤調整器校正十字盤，調整時請調整好長度，確保十字盤達到水平狀態，再進行基本機體設定，這樣才能確保飛行性能達到最佳效果。

Socket Collar Screw

圓頭內六角鉸套螺絲 M3x22mm

Slant Thread

Main Drive Gear Set

斜主齒輪組

M3 Nut

M3 防鬆螺帽

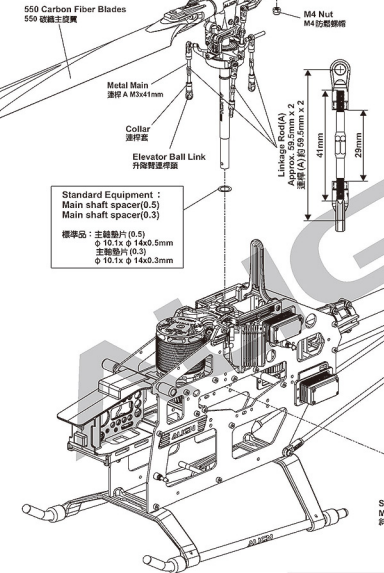

550 Carbon Fiber Blades

550 碳纖維主旋翼

Metal Main

連桿 A M3x41mm

Collar

連桿套

Elevator Ball Link

升降桿連桿

Linkage Rod(A)

Approx. 99.5mm x 2

連桿 (A) 約 99.5mm x 2

41mm

29mm

Standard Equipment :

Main shaft spacer(0.5)

Main shaft spacer(0.3)

標準品：主軸墊片(0.5)

φ 10.1x φ 14x0.5mm

主軸墊片(0.3)

φ 10.1x φ 14x0.3mm

## 60HB6

Socket Collar Screw

圓頭內六角鉸套螺絲 (M3x22mm) x 1

M3 Nut

M3 防鬆螺帽 x 1

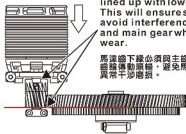

The lower edge of main gear need to be lined up with lower edge of pinion gear. This will ensure smooth meshing, and avoid interference between pinion's base and main gear which can lead to unusual wear.

馬達齒下緣必須與主齒輪下緣水平切齊，如此才能確保齒輪傳動順暢，避免馬達主齒輪底部與新製到主齒輪產生異常干涉磨損。



Apply a small amount of T43 thread lock when fixing a metal part.  
螺絲鎖附於金屬件時使用適量T43(螺絲膠)。



Original manufacturer packages contains product already assembled, please confirm every screw is firmly secured with T43. Do not use T43 on any plastic part.

原裝零件出廠包裝如果是組裝品，請需再確認各螺絲是否鎖緊上膠。請注意 T43 不可塗在任何的塑膠材質上。

### A MOUNTING ORIENTATION OF MICROBEAST PLUS MICROBEAST PLUS的安裝方向



Please visit Align download area to get the completed instruction manual at Align website.

更多詳細的設定操作說明請至官網下載專區下載。  
<http://www.align.com.tw/beastx/>

Microbeast PLUS provides 8 different direction choices can be installed on any position of helicopter.

Microbeast PLUS 提供8種不同方向選擇，可以安裝在機體的任何一個位置。

THE COLOR OF THE STATUS-LED SHOWS THE CURRENTLY SELECTED ORIENTATION:  
LED指示燈狀態顯示安裝方向：



Status LED Off  
Status-LED 燈熄滅\*



Status LED Flashing Purple  
Status-LED 燈紫色閃爍



Status LED Purple  
Status-LED 燈紫色



Status LED Flashing Red  
Status-LED 燈紅色閃爍



Status LED Red  
Status-LED 燈紅色



Status LED Flashing Blue  
Status-LED 燈藍色閃爍



Status LED Blue  
Status-LED 燈藍色



Status LED Flashing Red/Blue  
Status-LED 燈紅色藍色同時閃爍

Front  
機頭方向

\* Factory Setting

\* 出廠預設值

Option Equipment  
選購品

Microbeast PLUS  
Flybarless System  
無平槳系統

Foam Tape  
泡棉

Option Equipment  
選購品

Receiver  
接收器

**CAUTION** 注意 Please Fix The Battery on The Battery Mount Evenly.  
電池請平均固定於電池板上。

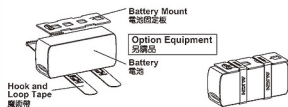

Insert The Battery From The Front  
電池從前方置入



**CAUTION** 注意

Slide the battery mounting plate along the rail until a "click" is heard to make sure the battery mounting plate is latched.  
將電池固定板順著電池滑軌裝入至發出「喀嗒」聲響，使電池固定板卡入卡榫。

Latch  
卡榫

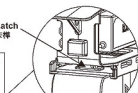

Press this latch to allow the battery to slide out along the rail.  
電池推出前請先將電池壓扣在內壓，順著滑軌推出。

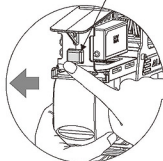

Battery Release Latch  
電池壓扣

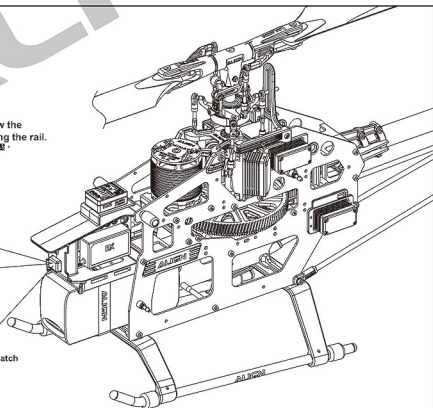

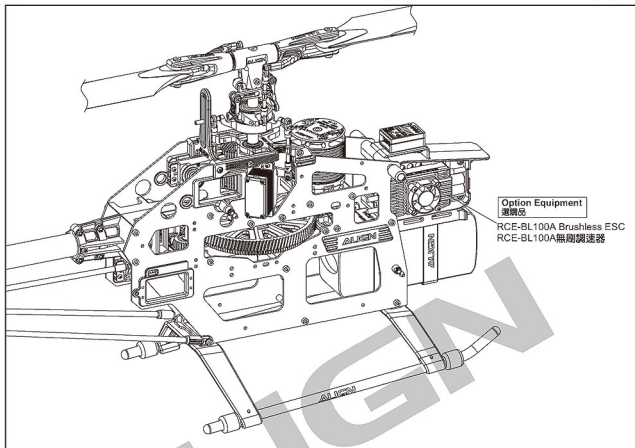

## CANOPY ASSEMBLY

## 機頭罩安裝

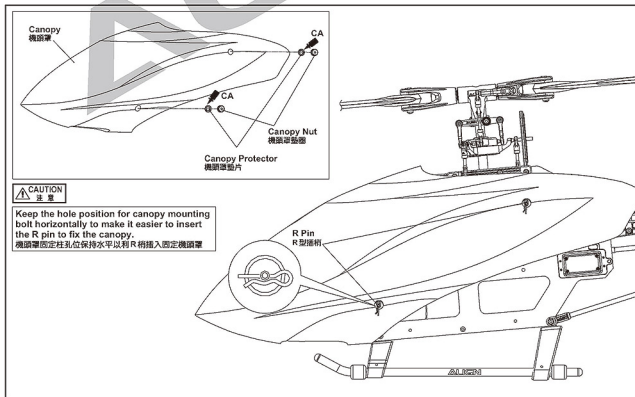

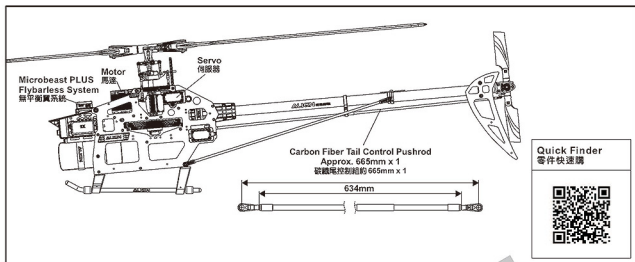

## MICROBEAST PLUS FLYBARLESS MANUAL

無平衡翼系統使用說明

ALIGN

MICROBEAST PLUS Flybarless System as ALIGN helicopter standard equipment, must and compatible with ALIGN standard equipment including blades, servos, motor, battery and so on, please refer to flight and setup instruction in this manual.

ALIGN 直昇機使用 MICROBEAST PLUS 無平衡翼系統，須搭配 ALIGN 直昇機標準配件(主旋翼、伺服器、馬達)與飛行操作、設定指示。

## USER NOTICE 使用注意事項



1. If assembling and operating the helicopter without using ALIGN standard equipment, including electronic equipment & blades...etc, please make sure there is a sufficiently large and stable power supply to your helicopter. If there is any abnormal voltage or insufficient power supply, suggest to upgrade the flybarless system to MICROBEAST PLUS HD (Optional) for better power back up.
2. Please refer to BEASTX MICROBEAST PLUS/HD website for MICROBEAST PLUS/HD assembly and setup instruction.
3. Any over use, incorrect setup, misassembly, incorrect modification or misuse will lead to abnormal voltage, electronic devices damage, structural interference, and insufficient power supply. Make sure to carefully check every assembly and setup refer to the manual instruction prior to every flight to prevent any unforeseen danger.

1. 安裝、操作您的直昇機時，如非使用 ALIGN 標準配件(含電子配件、主旋翼等)，請務必確定您的供電系統有足夠的供電能力，如發現電壓異常、供電不足，建議您升級使用 MICROBEAST PLUS HD 無平衡翼系統(選配)，以能確保充足、穩定的接收器電壓。
2. MICROBEAST PLUS/HD 使用、設定、接線，請參照 BEASTX MICROBEAST PLUS/HD 官方說明。
3. 任何電子配件、零件的設定、組裝、修改或操作不良所造成的電壓異常、電子零件損壞，即可能造成供電不穩定等問題，每趟飛行前須注意仔細檢查，防止機件及電子零件故障而引發不可預期的意外。

## MANUAL LINK 設定操作連結

MICROBEAST PLUS Flybarless System is the latest version out of the factory, please feel at ease using it. You can also link to BEASTX MICROBEAST PLUS/HD website to get the latest version and the latest news. MICROBEAST PLUS Flybarless System has available some different versions, each version has different programming and function, please make sure your Microbeast version and read its correct manual carefully before assembly or upgrading, especially you are upgrade from your V3.2.X, to V4.X.X by yourself, in order to avoid mistake or loss by any misunderstanding, please be sure that you have correct version and follow its setting method accordingly. And please refer to MICROBEAST PLUS V3.2.x and V4.2 instruction manual for operating and setting.

MICROBEAST PLUS 無平衡翼系統，出廠時主程式已是最新版本。您也可以連結至 BEASTX MICROBEAST PLUS/HD 官網查詢，隨時更新最新版本及各項最新訊息。部分版本因升級而設定及功能會有所不同，請確定您的版本並詳閱其說明書，尤其您是由 V3.2.x 升級至 V4.x.x，請務必深入了解版本之間的設定功能，以免錯誤而造成損失。操作設定請同時參照 V3.2.x 版及 V4.2 版使用說明書。



Please visit Align download area to get the completed instruction manual at Align website.

更多詳細的設定操作說明請至官網下載專屬下載。  
<http://www.align.com.tw/beastx/>



MICROBEAST PLUS  
 BEASTX MICROBEAST PLUS/HD  
 Optional Equipment  
 選購品

## PARTS IDENTIFICATION 各部位名稱

### MICROBEAST PLUS FLYBARLESS SYSTEM 無平衡翼系統

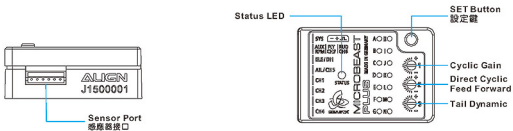

### MICROBEAST PLUS FLYBARLESS SYSTEM WIRING DIAGRAM 無平衡翼系統接線示意圖

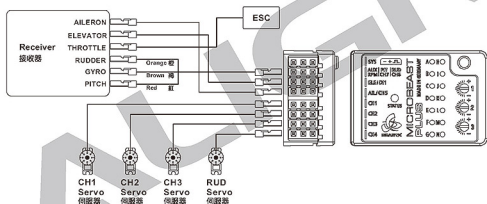

For detail connectivity, please scan QR Code then follow MICROBEASTPLUS manual.

詳細接線方式，請掃描QR Code連結至MICROBEAST PLUS說明書。



### MICROBEAST PLUS HD Flybarless System(Optional) MICROBEAST PLUS HD無平衡翼系統(選配)

If assembling and operating the helicopter without using ALIGN standard equipment, including electronic equipment & blades...etc, please make sure there is a sufficiently large and stable power supply to your helicopter. If there is any abnormal voltage or insufficient power supply, suggest to upgrade the flybarless system to MICROBEAST PLUS HD (Optional) for better power back up. Please refer to BEASTX website for MICROBEAST PLUS HD assembly and setup instruction.

安裝、操作您的直昇機時，如非使用ALIGN標準配件(含電子配件、主旋翼等)，請務必確定您的供電系統有足夠的供電能力，如發現電壓異常、供電不足，建議您升級使用MICROBEAST PLUS HD無平衡翼系統(選配)，以能確保充足、穩定的接收器電源。MICROBEAST PLUS HD使用、設定、接線，請參照MICROBEAST PLUS HD官方說明。

To set this option is to turn on the transmitter and connect to BEC power.

**Note:** For the safety, please do not connect ESC to the brushless motor in order to prevent any accident caused by the motor running during the setting.

此項設定只要開啟發射器，接上BEC電源即可進行操作。

**注意：**為了安全起見，設定前請先不要將無刷調速器與無刷馬達三條線接上，以免調整時啟動馬達而發生危險。

## SERVO CONFIGURATION 伺服器配置

Following the servo configuration diagram on right, plug the servos to Gyro.

請依照右圖顯示的伺服器名稱，將伺服器接到陀螺儀。

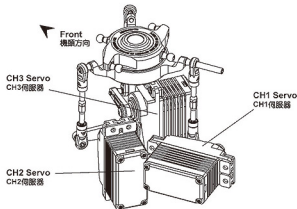

## ADJUSTMENTS FOR GYRO AND TAIL NEUTRAL SETTING

## 陀螺儀與尾翼中立點設定調整

Turn off Revolution mixing (RVMX) mode on the transmitter, then set the gain switch on the transmitter and the gyro to non-head lock mode, or disable gain completely. After setting the transmitter, connect the helicopter power and proceed with rudder neutral point setting. **Note:** When connecting to the helicopter power, please do not touch tail rudder stick and the helicopter, wait for 3 seconds for gyro to enable, and the rudder servo horn should be 90 degrees to the tail servo. Tail pitch slider should be half way on the tail output shaft. This will be the standard rudder neutral point. After completing this setting, set the gain switch back to heading lock mode, with gain at around 70%.

發射器內陀螺儀設定請關閉板轉定控模式，並將發射器上的感度開關與陀螺儀切至“非鎖定模式”或將陀螺儀感度關閉。發射器設定完成後接上直昇機電源，即可進行尾舵中立點設定。注意：當接上直昇機電源時請勿碰動尾舵搖桿或直昇機機體，待3秒陀螺儀開機完成後，尾舵控制桿與尾舵伺服器約成90度，尾舵翼控制組須正確置於尾橫軸約中間位置，即為標準尾舵中立點設定，設定完成後，切換至“鎖定模式”，感度設約70%左右。

## TAIL NEUTRAL SETTING 尾中立點設定

After the gyro is enable and under non-head lock mode, correct setting position of tail servo and tail pitch assembly is as photo. If the tail pitch assembly is not in the middle position, please adjust the length of rudder control rod to trim.

陀螺儀開機後，在非鎖定模式下，尾舵伺服器與尾舵Pitch控制組正確擺置位置。若尾舵Pitch控制組未居中時請調整尾舵控制桿的長度來修正。

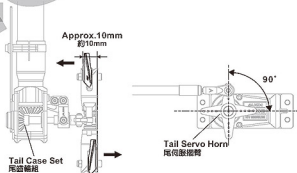

## HEAD LOCK DIRECTION SETTING OF GYRO 陀螺儀鎖定方向設定

To check the head lock direction of gyro is to move the tail clockwise and the tail servo horn will be trimmed counterclockwise. If it trims in the reverse direction, please switch the gyro to "REVERSE".

陀螺儀鎖定方向確認，當手搖尾部順時鐘旋轉，尾舵控制桿應反時鐘修正。反向時請切換陀螺儀上“鎖定反向”開關修正。







The rotational speed must set below 2,700RPM for safety to prevent any unexpected danger.

直昇機的主旋翼有安全使用轉速，飛行時不可超過2,700RPM，超轉會導致不可預期的危險，甚至危害他人生命財產。

GENERAL FLIGHT 一般飛行模式

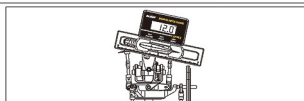

Stick position at high/Throttle 100%/Pitch+12°  
搖桿高速/油門100%/Pitch+12°

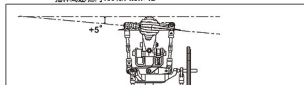

Stick position at Hovering/Throttle 70%/Pitch+5°  
搖桿停懸/油門70%/Pitch+5°

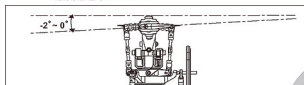

Stick position at low/Throttle 0%/Pitch-2°-0°  
搖桿低速/油門0%/Pitch-2°-0°

GENERAL FLIGHT 一般飛行模式

Throttle 油門	Pitch 螺距
5 100% High speed 100% 高速	+12°
4 85%	
3 60%~65% Hovering 60%~65% 停懸	+5°
2 40%	
1 0% Low speed 0% 低速	-2°-0°

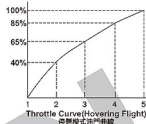

Pitch and Rotation Speed Pitch與轉速關係

TIP: It is recommended to use a lower pitch setting when using higher RPM/Head speed. This will allow for better power.

搭配要領: 如果應用較高轉速馬達動力建議降低螺距 Pitch，將獲得較佳動力效能。

3D FLIGHT 3D特技飛行模式



Stick position at high/Throttle 100%/Pitch+12°  
搖桿高速/油門100%/Pitch+12°

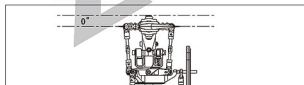

Stick position at middle/Throttle 90%/Pitch 0°  
搖桿中速/油門90%/Pitch 0°

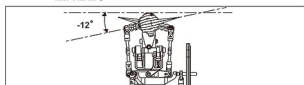

Stick position at low/Throttle 100%/Pitch-12°  
搖桿低速/油門100%/Pitch-12°

IDLE 1: SPORT FLIGHT

Throttle 油門	Pitch 螺距
5 100%	+10°~+12°
4 75%	
3 70%	+5°
2 75%	
1 80%	-5°

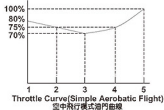

IDLE 2: 3D FLIGHT

Throttle 油門	Pitch 螺距
5 100% High 100% 高	+12°
3 85% Middle 85% 中	0°
1 100% Low 100% 低	-12°

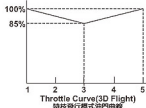

1. Pitch range : Approx.  $\pm 14^\circ$ .
2. If the pitch is set too high, it will result in shorter flight duration and poor motor performance.
3. Setting the throttle to provide a higher speed is preferable to increasing the pitch too high.

1. 螺距(Pitch)進行程約  $\pm 14^\circ$ 。
2. 過大螺距設定，會導致動力與飛行時間降低。
3. 動力提升以較高轉速的設定方式，優於螺距過大的設定。



While pitch set at 0 degree, make sure to set throttle below 85%.

螺距 0 度點，油門勿超過 85%。

## RCM-BL730MX(960KV /4230) MOTOR RCM-BL730MX(960KV /4230) 無刷馬達

This new Brushless motor developed by the ALIGN POWER R&D TEAM, is packed with the latest, cutting edge technology available today. It features exceptional levels of high-torque power. The 730MX utilizes an 8-pole outrunner stator-rotor and unrivaled Ndfeb extra strong magnets that traditional magnets cannot compare to. Also included is a high temperature, wear-resisting, low friction, double ZZ high efficiency bearing. The 730MX will be the most revolutionary motor operating on low current amperage, and delivering high torque to RC models.

由亞拓動力團隊獨家研發出新款的無刷馬達，具有超高扭力特色，採用12槽矽鋼片、8極外轉子以及傳統磁鐵無法比擬的軟磁強磁鐵，搭配高溫耐磨的雙ZZ超高效率精密軸承設計，電流低、扭力強，將是下一代運動革命中的最具代表性一顆星。

## SPECIFICATION 尺寸規格

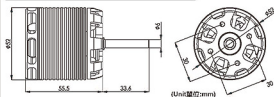

## ILLUSTRATION 接線示意圖



KV	KV值	960KV(RPM/V)	Input voltage	輸入電壓	6S
Stator Diameter	定子外徑	42mm	Stator Thickness	定子高度	30mm
Stator Arms	矽鋼片槽數	12	Magnet Poles	磁鐵極數	8
Max continuous current	最大持續電流	115A	Max instantaneous current	最大瞬間電流	195A(5sec)
Max continuous power	最大持續功率	2550W	Max instantaneous power	最大瞬間功率	4330W(5sec)
Dimension	尺寸	Shaft $\phi$ 6x52x89.1mm	Weight	重量	Approx. 380g

The motor rotates in different direction with different brand ESCs. If the wrong rotating direction happens, please switch any two cables to make the motor rotates in right direction.

由於各品牌電子變速器的馬達啟動轉向不盡相同，若發生轉向錯誤時，請將馬達與電子變速器的接線任兩條對調即可。

## RCE-BL100A BRUSHLESS SPEED CONTROLLER INSTRUCTION MANUAL

## 無刷調速器使用說明

## PRODUCT FEATURES 產品特色



RCE-BL100A Brushless ESC can be set up by ALIGN ASBOX Multifunction Programmer. So please scan QR code for ALIGN website start downloading for more information: <http://www.align.com.tw/download-en/asbox/>

RCE-BL100A無刷調速器可透過ALIGN ASBOX多功能設定盒進入參數設定，請掃描QR Code連結至亞拓網站下載相關資訊：  
<http://www.align.com.tw/download-en/asbox/>

- High performance microprocessor for excellent motor speed-governing and super soft start-up.
- Microprocessor powered by independent DC regulator has better anti-interference performance, which greatly reduces the risk of losing control.
- DEO (Driving Efficiency Optimization) Technology adopted greatly improves throttle response & driving efficiency, reduces ESC temperature.
- New switch-mode BEC with adjustable output voltage ranges from 5V to 8V and continuous/peak current of 10A/25A.
- BEC is separated from other circuits of the ESC, it may keep normal output even when MOSFET board of the ESC is burnt or breakdown.
- Multiple flight modes: Fixed-wing, Helicopter (Linear Throttle), Helicopter (Elf Governor), Helicopter (Store Governor).
- New governor program with adjustable governor parameter P/I brings excellent speed-governing function, keep the propeller revs stability when the load changes dramatically.
- Data logging records the standardized RPM, minimum voltage and maximum temperature of the flight.
- "Auto restart function" can manually interrupt the auto rotation and quickly restart the motor to avoid crashes caused by incorrect operations.
- Independent output port for RPM (that is: motor speed) signals. Separate programming port for ESC parameter setup through ALIGN ASBOX Multifunction Programmer.
- WIFI module for programming the ESC wirelessly with your smart phone (IOS or Android).
- Allow for data checking, ESC programming, speed curve checking, and firmware upgrade online. (ALIGN ASBOX Multifunction Programmer or WIFI Express is needed)
- 使用高性能微處理器，相容多種無刷馬達，具備優異的定速和緩衝動性能。
- 微處理器採用獨立的穩壓IC供電，具有更好的抗干擾能力，降低失控的可能性。
- 採用同步步進流勵效率優化技術 (DEO, Driving Efficiency Optimization)，油門回應更快，驅動效率更高，電子調速器溫度更低。
- 使用新的大功率開關穩壓BEC，輸出電壓在5-8V之間可調，瞬間輸出電流提升至25A。
- BEC模組和電子調速器其他電路相互獨立，當電子調速器功率輸出超規格等故障時，最大限度保證BEC正常輸出，提供救機機會。
- 具有「固定翼模式/直升機線性油門模式/直升機定速模式/直升機存儲定速模式」4種飛行模式。
- 使用新的直升機定速模式，定速度可調，易於操作；具備優異的定速效果，在負荷劇變化的情況下，保證螺旋槳穩定運轉。
- 具有飛行資料記錄功能，可記錄每次飛行的最低電壓、最高溫度資料、最大電流、穩定轉速。
- 具有熄火掉落保護功能，在保護時間內可手動中斷熄火降落過程並快速重新啟動馬達，避免因失控而墜機。
- 具有轉速 (RPM) 訊號輸出介面。
- 具備獨立參數設定介面，用於連接多功能LCD專業程式設計ALIGN ASBOX多功能設定盒進行參數設定。
- 支援WIFI無線設定，透過手機端(蘋果&安卓)軟體可完成所有參數設置(需要WIFI模組)。
- 支援線上讀取、設定電壓設定、查看速度曲線表(存儲模式下)，升級電子調速器固件(需要LCD參數設定盒或WIFI模組)。

## SPECIFICATIONS 產品規格

Model 型號	Main Applications 應用範圍	Input Voltage 輸入電壓	Cont./Peak Current (10s) 持續/瞬間 (10秒) 電流	BEC Voltage BEC 電壓
RCE-BL100A Brushless ESC	For 500-550 Class Helicopter (Propeller: 470-575mm) 500-550級電動直升機 (槳長: 470-575mm)	3-6S LiPo Battery/11.1V-22.2V 3-6S鋰電池/11.1V-22.2V	100A/170A	Switch-mode, 5V-8V Adjustable Voltage (Step: 0.1V), 10A/25A Cont./Peak Current 開關模式BEC, 輸出電壓5V-8V可調節 精度為0.1V每階, 輸出電流持續 10A, 瞬間25A
	Throttle Signal/BEC Output Wire/RPM Signal Transmission Wire 油門信號/BEC輸出線/RPM信號傳輸線	White/Red/Black: Throttle Signal Wire ; Red/Black: BEC Output Wire ; Yellow: RPM Signal Transmission Wire 白、紅、黑三色線為油門信號線; 紅、黑二色線為BEC輸出 線; 黃色為RPM信號傳輸線	Size/Weight 尺寸重量	Separate Programming Port 獨立參數程式設計介面
			78.5x38.1x21mm/138g	For connecting ALIGN ASBOX Multifunction Programmer, WIFI module. 用於連接多功能ICD專業程式設計設定 盒或WIFI模組

## USER GUIDE 使用說明書



The default throttle range of this ESC is from 1100 $\mu$ s to 1940 $\mu$ s, so you need to re-calibrate the throttle range when the first time you use this ESC or after you replace the transmitter.

電子調速器的油門行程出廠預設值為1100 $\mu$ s-1940 $\mu$ s, 當首次使用電子調速器或者更換其他遙控器使用時, 均應重新設定油門行程。

### I. Connections 接線示意圖

- RPM Signal Wire (Yellow):** plug it into the RPM input channel on the flybarless system. (This wire can be used for provide RPM signal data when using external speed-governing device.)
- BEC Output Wire (Red/Black):** plug it into the battery channel or any unoccupied channel on the receiver. (For better BEC power supply, we recommend plugging this wire into the battery channel or any unoccupied channel on FBL system if the FBL system is permitted.)
- Throttle Signal Wire (White/Red/Black):** plug it into the throttle channel on the receiver or the corresponding channel on the FBL system, for which channel you should plug it in, it depends on what kind of receiver and FBL system you use. The White wire is for transmitting throttle signals, the Red & Black cables are parallelly connected in the BEC output wire, which means BEC voltage output wire and ground cable.

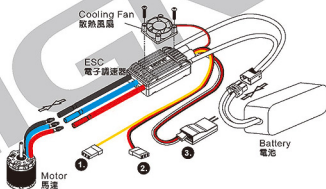

- RPM信號線(黃): 插入無平衡翼系統轉速輸入通道; (當使用外部定速時, 可使用RPM信號線提供轉速信號輸入。)
- BEC輸出線(紅、黑): 選擇額外的BEC輸出線插入接收機電池專用通道或任意空閒通道。(為獲得更好的BEC供電效果, 在無平衡翼系統允許的情況下, 建議將BEC線插入無平衡翼系統的電池專用通道或任意空閒通道。)
- 油門信號線(白、紅、黑): 插入接收機油門通道或無平衡翼系統對應通道, 具體接收機類型及無平衡翼系統類型而定。其中白線用於傳送油門信號, 而紅線和黑線分別並聯在內部BEC的輸出端(即BEC電壓輸出線和地線)。

### II. Throttle Range Calibration 油門行程校準操作方式



During the ESC/Radio calibration, please set the throttle curve to NORMAL and ensure the corresponding throttle amounts to the maximum throttle endpoint and the minimum throttle endpoint on your transmitter are respectively 100% and 0%.

進行油門行程校準時, 請將油門曲線設置為NORMAL, 並確保遙控器油門最高點對應的油門值為100%, 油門最低點對應的油門值為0%

- Turn on the transmitter and move the throttle stick to the top position.  
開啟遙控器, 將油門打到最高點
- Connect the ESC to a battery. The motor will emit 2 "123" indicating the ESC is powered on normally.  
電子調速器接電池, 馬達嗶嗶"123"提示音, 表示供電正常
- 5 seconds later, the motor will emit two short beeps indicating the maximum throttle position has been successfully calibrated and accepted.  
等待5秒, 馬達發出"嗶-嗶"雙短鳴音, 表示油門最高點校準成功
- Move the throttle stick to the bottom position. 1 second later, a short beep will emit indicating the minimum throttle position has been accepted.  
將油門搖杆推到最低, 等待1秒, 油門最低點校準成功
- The ESC will keep beeping indicating the number of LiPo cells you have plugged in.  
馬達發出N聲嗶音, 表示鋰電池Cell數
- A long beep represents system is well done, ready to fly.  
馬達發出"嗶"一聲長音表示系統準備就緒, 可隨時起飛

## PLEASE PRACTICE SIMULATION FLIGHT BEFORE REAL FLYING 飛行前請先熟練電腦模擬飛行













A safe and effective practice method is to use the transmitter flying on the computer through simulator software sold on the market. Do a simulation flight until you familiarize your fingers with the movements of the rudders, and keep practicing until the fingers move naturally.

1. Place the helicopter in a clear open field ( Make sure the power OFF ) and the tail of helicopter point to yourself.
2. Practice to operate the throttle stick (as below illustration) and repeat practicing "Throttle high/low", "Aileron left/right", "Rudder left/right", and "Elevator up/down".
3. The simulation flight practice is very important, please keep practicing until the fingers move naturally when you hear operation orders being call out.

在還沒瞭解直昇機各動作的操控方式前，嚴禁實機飛行，請先進行電腦模擬飛行的練習，一種最有效、最安全的練習方式，就是透過市面販售的模擬軟體，以遙控器在電腦上模擬飛行，熟悉各種方向的操控，並不斷的重複，直到手指可熟練的控制各個動作及方向。

1. 將直昇機放在空曠的地方(確認電源為關閉)，並將直昇機的機尾對準自己。

2. 練習操作遙控器的各搖桿(各動作的操作方式如下圖)，並反覆練習油門高/低、副翼左/右、升降舵前/後及方向舵左/右操作方式。
3. 模擬飛行的練習相當重要，請重複練習直到不需思索，手指能自然隨著喊出的指令移動控制。

Mode 1	Mode 2	Illustration 圖示
 Aileron 副翼 	← Move Left 左移 ↶ Rotate Left 左翻 ↷ Rotate Right 右翻	 Move Right 右移 ↸ Rotate Right 右翻
 Elevator 升降/前後 	← Fly Forward 前進 ↶ Forward Rotate 前翻	 Fly Backward 後退 ↷ Backward Rotate 後翻
 Throttle 油門 		 Ascent 上升 ↑ Descent 下降 ↓
 Rudder 方向 	↷ Turn Right 右旋 ↶ Turn Left 左旋	

## FLIGHT ADJUSTMENT AND NOTICE 飛行調整與注意



- ⊙ Check if the screws are firmly tightened.
- ⊙ Check if the transmitter and receivers are fully charged.
- ⊙ 再次確認→螺絲是否鎖固?
- ⊙ 發射器和接收器電池是否足勢。



If there are other radio control aircraft at the field, make sure to check their frequencies and tell them what frequency you are using. Frequency interference can cause your model, or other models to crash and increase the risk of danger. 假使飛行場有其他遙控飛機，請確認他們的頻率，並告知他們您正在使用的頻率，相同的頻率會造成干擾導致失控和大大地增加風險。

## STARTING AND STOPPING THE MOTOR 啟動和停止馬達



First check to make sure no one else is operating on the same frequency. Then place the throttle stick at lowest position and turn on the transmitter.

首先確認附近沒有其他相同頻率的機，然後打開發射器將油門搖桿推到底點。

- Check the movement.
- 動作確認



ON! Step1  
First turn on the transmitter.  
先開啟發射器



ON! Step2  
Connect to the helicopter power  
接上直昇機電源



Check if the throttle stick is set at the lowest position.  
確認油門搖桿是在最低的位置。

- ⊙ Are the rudders moving according to the controls?
- ⊙ Follow the transmitter's instruction manual to do a range test.
- ⊙ 方向舵是否隨著控制方向移動?
- ⊙ 根據發射器說明書進行距離測試。

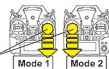

OFF! Step3  
Reverse the above orders to turn off.  
關閉電源時請依上述操作動作反執行。



This procedure is best performed on soft surfaces such as grass. The use of rubber skid stopper is recommended on hard surface to prevent vibration feedback from the ground to Gyro, resulting in over-corrections.

將直昇機置於柔軟地面上，建議硬地起飛腳架裝上避震墊圈。避免升空前腳架與硬地的地面震動太大反饋至機身上的陀螺儀，影響無平衡翼系繞升空前過度修正。

Rubber skid stoppers installed  
裝上避震墊圈



If swashplate should tilt prior to lift off, do not try to manually trim the swashplate level. This is due to vibration feedback to the Gyro, and will disappear once helicopter lifts off the ground. If manual trim is applied, helicopter will tilt immediately after liftoff.

直昇機離地前，十字盤可能因陀螺儀震動的反應，使十字盤有傾斜的情形，此時請勿刻意將十字盤修正為水平狀態，此現象只要離地升空時立即解除，可獲平穩升空；若刻意將十字盤修正為水平時，反而會造成感應器過度修正，一離地即偏往修正方向的危險。

## MAIN ROTOR ADJUSTMENTS 主旋翼雙槳平衡調整

- Before adjusting, apply a red piece of tape on one blade, or paint a red stripe with a marker or paint to identify on blade.
- Raise the throttle stick slowly and stop just before the helicopter lifts off ground. Look at the spinning blades from the side of the helicopter.
- Look at the path of the rotor carefully. If the two blades rotate in the same path, it does not need to adjustment. If one blade is higher or lower than the other blade, adjust the tracking immediately.

- 調整前先在其中一支主旋翼的翼端，貼上有顏色的貼紙或畫上顏色記號，方便雙槳調整辨識。
- 慢慢的把油門搖桿到高点並且停止，在飛機離地前，從飛機側邊觀察主旋翼轉動。
- 仔細觀察旋翼軌跡（假如兩支旋翼移動都是相同軌跡，則不需要調整；可是如果一支旋翼較高或較低產生“雙槳”的情形時，則必須立刻調整軌跡）。

- When rotating, the blade with higher path means the pitch is too big. Please shorten ball link for regular trim.
- When rotating, the blade with lower path means the pitch is too small. Please lengthen ball link for regular trim.

- 旋翼轉動時較高軌跡的主旋翼表示螺距(PITCH)過大，請調短連桿調整。
- 旋翼轉動時較低軌跡的主旋翼表示螺距(PITCH)過小，請調長連桿調整。



Tracking adjustment is very dangerous, so please keep away from the helicopter at a distance of at least 10m.

調整軌跡非常危險，請於距離飛機最少10公尺的距離。

Incorrect tracking may cause vibrations. Please repeat adjusting the tracking to make sure the rotor is correctly aligned. After tracking adjustment, please check the pitch angle is approx. +5~6° when hovering.

不正確的旋翼軌跡會導致震動，請不斷重複調整軌跡，使旋翼軌跡精準正確。在調整軌跡後，確認一下Pitch角度在停旋時應為大約+5~6°。

Color Mark 有標示記號的主旋翼



## FLIGHT ADJUSTMENT AND NOTICE 飛行調整與注意



⊙ Do not attempt to grab or make contact with the helicopter while the main blades are in motion and keep your eyes away from the helicopter. During take-off, landing, and flight, be sure to keep the helicopter away from all obstacles. Operators must stand at least 10 meters away from the helicopter to avoid injury caused by loose parts due to improper assembly or any unforeseen dangers.

⊙ 嚴禁用手抓取運行中的直昇機，並禁止將直昇機對著眼睛，當主旋翼轉動後，或起飛/試飛時，務必遠離障礙物，站立位置必需距離10公尺以上，避免因人為組裝不當造成零件脫落，而引發不可預期的財物及人員損傷。



⊙ Make sure that no one or obstructions in the vicinity.

⊙ For flying safety, please carefully check if every movement and directions are correct when hovering.

⊙ 確認鄰近地區沒有人和障礙物。

⊙ 為了飛行安全，您必須先確認停懸時各項操縱動作是否正常。



Do not attempt to fly until you have some experiences with the operation of the helicopter.

嚴禁無熟練操作飛行經驗者操控飛行。

## STEP 1 THROTTLE CONTROL PRACTICE 油門控制練習

- ⓐ When the helicopter begins to lift-off the ground, slowly reduce the throttle to bring the helicopter back down. Keep practicing this action until you control the throttle smoothly.

ⓑ 當直昇機開始離地時，慢慢降低油門將飛機降下。持續練習飛機從地面上升和下降直到感覺得油門控制很順。

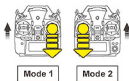

## STEP 2 AILERON AND ELEVATOR CONTROL PRACTICE 副翼和升降控制練習

1. Raise the throttle stick slowly.  
2. Move the helicopter in any direction back, forward, left and right, slowly move the aileron and elevator sticks in the opposite direction to fly back to its original position.

1. 慢慢升起油門搖桿。  
2. 使直昇機依指示：移動向後/向前/向左/向右，慢慢的反向移動副翼和升降搖桿並將直昇機回到原來位置。

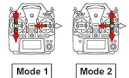

ⓐ If the nose of the helicopter moves, please lower the throttle stick and land the helicopter. Then move your position diagonally behind the helicopter 10M and continue practicing.

ⓑ If the helicopter flies too far away from you, please land the helicopter and move your position behind 10M and continue practicing.

ⓒ 當直昇機機頭偏移時，請降低油門並且降落，然後移動自己的位置到直昇機的正後方 10 公尺再繼續練習。

ⓓ 假如直昇機飛離你太遠，請先降落直昇機，並到直昇機後 10 公尺再繼續練習。

## STEP 3 RUDDER CONTROL PRACTICING 方向舵操作練習

1. Slowly raise the throttle stick.  
2. Move the nose of the helicopter to right or left, and then slowly move the rudder stick in the opposite direction to fly back to its original position.

1. 慢慢升起油門搖桿。  
2. 將直昇機機頭移動左或右，然後慢慢反向移動方向舵搖桿並將直昇機飛回原本位置。

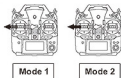

## STEP 4

After you are familiar with all actions from STEP1 to 3, draw a circle on the ground and practice within the circle to increase your accuracy.

當你覺得 STEP1-3 動作熟悉了，在地上畫個圈並在這個圓圈的範圍內練習飛行，以增加你操控的準確度。

ⓐ You can draw a smaller circle when you get more familiar with the actions.

ⓑ 當你更加習慣操作動作，你可以畫更小的圓圈。



## STEP 5 DIRECTION CHANGE AND HOVERING PRACTICE 改變直昇機方向和練習停旋

After you are familiar with STEP1 to 4, stand at side of the helicopter and continue practicing STEP1 to 4. Then repeat the STEP1 to 4 by standing right in front of the helicopter.

當你覺得STEP1-4動作熟悉了，站在面對直昇機側邊並繼續練習STEP1-4。之後，站在直昇機機頭右邊重複步驟練習。



	Problem 狀況	Cause 原因	Solution 對策
Blade Tracking 雙槳平衡	Tracking is Off 雙槳	Pitch linkage rods are not even length PITCH連桿長度調整不平均	Adjust length of ball link. 調整連桿球長
Hover 停懸	Headspeed too low 主旋翼轉速偏低	Excessive pitch 主旋翼的PITCH偏高	Adjust ball link to reduce pitch by 4 to 5 degrees. 調整連桿球降低Pitch約+4-5度
		Hovering throttle curves too low 停懸點油門曲線過低	Increase throttle curve at hovering point on transmitter (around 60%) 調高停懸點油門曲線(約60%)
	Headspeed too high 主旋翼轉速偏高	Not enough pitch 主旋翼的PITCH偏低	Adjust ball link to increase pitch by 4 to 5 degrees. 調整連桿球提高Pitch約+4-5度
		Hovering throttle curves too high 停懸點油門曲線過高	Decrease throttle curve at hovering point on transmitter (around 60%) 調低停懸點油門曲線(約60%)
Rudder Response 尾舵反應	Drifting of tail occurs during hovering, or delay of rudder response when centering rudder stick. 停懸時尾翼向某一邊偏移，或移動方向舵並回復到中立點時，尾翼產生延遲，無法停頓在所控制位置上。	Rudder neutral point improperly set 尾中立點設定不當	Reset rudder neutral point 重設尾中立點
	Tail oscillates (hunting, or wags) at hover or full throttle 停懸或全油門時尾翼左右來回搖擺。	Rudder gyro gain too low 尾舵陀螺儀敏感度偏低	Increase rudder gyro gain 增加尾舵陀螺儀敏感度
		Rudder gyro gain too high 尾舵陀螺儀敏感度偏高	Reduce rudder gyro gain 降低尾舵陀螺儀敏感度

If above solution does not resolve your issues, please check with experienced pilots or contact your Align dealer.

※在做完以上調整後，仍然無法改善情況時，應立即停止飛行並向有經驗的飛手諮詢或連絡您的經銷商。

Thank you for purchasing and supporting ALIGN products.

The Align Team is dedicated to you by innovating and developing new RC Helicopters, Multicopters, and FPV Racing Quads. We strive to provide a more diversified experience for our customers. Visit our website at [www.align.com.tw](http://www.align.com.tw) for latest news, information, and updates about our extensive line of products for the RC enthusiasts.

Good Flying!

再次感謝您對亞拓系列商品的喜愛與支持，您的肯定是對我們最大的認同。

亞拓團隊秉持創新研發的精神，開發遙控直昇機／多軸飛行機／穿越機系列商品，提供給您體驗更多樣化的飛行樂趣。您可以透過下列連結，隨時瞭解亞拓的最新動態，以及各項訊息分享。

祝福您有一個愉快的飛行體驗。



**ALIGN T-REX Helicopter 亞拓遙控直昇機**  
<http://www.align.com.tw/helicopter-en/>



**ALIGN Multicopter 亞拓多軸飛行機**  
<http://www.align.com.tw/multicopter-en/>



**ALIGN FPV Racing Quad 亞拓穿越機**  
<http://www.align.com.tw/multicopter-en/mr25/>



**ALIGN Website 亞拓官網**  
<http://www.align.com.tw>



**ALIGN Shopping Cart 亞拓購物車**  
<http://shop.align.com.tw/index.php?language=en>



**ALIGN Quick Finder 亞拓零件快速購**  
<http://shop.align.com.tw/partfinder.php?language=en>



**ALIGN FaceBook**  
<https://www.facebook.com/Align-Corporation-194493419543/?ref=mf>



**ALIGN Instagram**  
<https://instagram.com/aligncorporation/>



**ALIGN YouTube**  
[https://www.youtube.com/channel/UCaPJ\\_K5DNo7HSmp1eytUvMQ](https://www.youtube.com/channel/UCaPJ_K5DNo7HSmp1eytUvMQ)



**ALIGN Youku**  
<http://i.youku.com/u/UMTQ0NjEwNjczNg==>



**ALIGN**



# ALIGN

## Specifications & Equipment/規格配備:

Length/機身長:1163mm

Height/機身高:344mm

Main Blade Length/主旋翼尺寸:550mm

Tail Rotor Length/尾旋翼尺寸: 90mm

Main Rotor Diameter/主旋翼直徑:1248mm

Tail Rotor Diameter/尾旋翼直徑:254mm

Motor Drive Gear/馬達齒輪:16T

Main Drive Gear 傳動主齒輪:112T

Autorotation Tail Drive Gear/尾傳動主齒:131T

Tail Drive Gear/尾翼傳動齒:34T

Drive Gear Ratio/齒輪傳動比: 7:1:3.85

Flying Weight/全配重: Approx. 2590g(Super Combo) / 2540g(Combo)

