

# 3GX Flybarless System

# ALIGN

## INSTRUCTION MANUAL

## 使用說明書

### HEG3GX01T

# 3GX

Compact



**Intelligence !**

**Technology !**

**Deftness !**



CONTENTS	
1	INTRODUCTION 前言
1~2	SAFETY NOTES 安全注意事項
3~14	3GX FLYBARLESS FL760 MANUAL 無平衡翼系統使用說明
15	3GX SETUP TABLE 簡易設定表
16~17	3GX FLYBARLESS PREFLIGHT CHECK 飛行前測試程序
17	FLIGHT ADJUSTMENT AND SETTING 飛行動作調整與設定
20	3GX FLYBARLESS FLIGHT TEST PROCEDURE 飛行測試程序
21	TROUBLESHOOTING 飛行中狀況排除
22	Q & A 問與答

Please read this manual carefully before assembling .  
We recommend that you keep this manual for future reference regarding tuning and maintenance.

進入遙控世界之前必須告訴您許多相關的知識與注意事項，以確保您能夠在學習的過程中較得心應手。在開始操作之前，請務必詳閱本說明書，相信一定能夠給您帶來相當大的幫助，也請您妥善保管這本說明書，以作為日後參考。

Compatible with helicopter of all sizes from T-REX 250 to T-REX 800 3GX Flybarless. Here we use T-REX 800 as an example .

3GX Flybarless 電子設備相容小型直昇機至大型直昇機 T-REX 250 ~ T-REX 800 。在此我們以 T-REX 800 作為操作範例。

Thank you for buying ALIGN Products. The 3GX Flybarless System is designed as an easy to use, . Please read the manual carefully before assembling the model, and follow all precautions and recommendations located within the manual. Be sure to retain the manual for future reference, routine maintenance, and tuning. The 3GX Flybarless System is a new product developed by ALIGN, providing flying stability for beginners, full aerobatic capability for advanced fliers, and unsurpassed reliability for customer support.

感謝您選購亞拓產品，為了讓您容易方便的使用3GX無平衡翼系統、請您詳細的閱讀完這本說明書之後再進行組裝以及操作，同時請您妥善的保存這本說明書、作為日後進行調整以及維修的參考。3GX無平衡翼系統是由亞拓自行研發的新產品，不論您是需求飛行穩定性的初學者或是追求性能的飛行愛好者。3GX無平衡翼系統將是您最佳的選擇。

### WARNING LABEL LEGEND 標誌代表涵義

 FORBIDDEN 禁止	<b>Do not attempt under any circumstances.</b> 在任何禁止的環境下，請勿嘗試操作。
 WARNING 警告	<b>Mishandling due to failure to follow these instructions may result in damage or injury.</b> 因為疏忽這些操作說明，而使用錯誤可能造成財產損失或嚴重傷害。
 CAUTION 注意	<b>Mishandling due to failure to follow these instructions may result in danger.</b> 因為疏忽這些操作說明，而使用錯誤可能造成危險。

### IMPORTANT NOTES 重要聲明

R/C helicopters, including the are not toys. R/C helicopter utilize various high-tech products and technologies to provide superior performance. Improper use of this product can result in serious injury or even death. Please read this manual carefully before using and make sure to be conscious of your own personal safety and the safety of others and your environment when operating all ALIGN products. Manufacturer and seller assume no liability for the operation or the use of this product. This product is intended for use only by adults with experience flying remote control helicopters at a legal flying field. After the sale of this product we cannot maintain any control over its operation or usage.

**As the user of this product, you are solely responsible for operating it in a manner that does not endanger yourself and others or result in damage to the product or the property of others.**

遙控直昇機並非玩具，它是結合了許多高科技產品所設計出來的休閒用品，所以商品的使用不當或不熟悉都可能會造成嚴重傷害甚至死亡，使用之前請務必詳讀本說明書，勿輕忽並注意自身安全。注意！任何遙控直昇機的使用，製造商和經銷商是無法對使用者於零件使用的損耗異常或組裝不當所發生之意外負任何責任，本產品是提供給有操作過模型直昇機經驗的成人或有相當技術的人員在旁指導於當地合法遙控飛行場飛行，以確保安全無虞下操作使用，產品售出後本公司將不負任何操作和使用控制上的任何性能與安全責任。

做為本產品的使用者，您，是唯一對於您自己操作的環境及行為負全部的責任之人。

We recommend that you obtain the assistance of an experienced pilot before attempting to fly our products for the first time. A local expert is the best way to properly assemble, setup, and fly your model for the first time. The 3GX Flybarless System requires a certain degree of skill to operate, and is a consumer item. Any damage or dissatisfaction as a result of accidents or modifications are not covered by any warrantee and cannot be returned for repair or replacement. Please contact our distributors for free technical consultation and parts at discounted rates when you experience problems during operation or maintenance. As Align Corporation Limited has no control over use, setup, final assembly, modification or misuse, no liability shall be assumed nor accepted for any resulting damage or injury. By the act of use, setup or assembly, the user accepts all resulting liability.

模型商品屬於需高操作技術且為消耗性之商品，如經拆裝使用後，會造成不等情況零件損耗，任何使用情況所造成商品不良或不滿意，將無法於保固條件內更換新品或退貨，如遇有使用操作維修問題，本公司全省分公司或代理商將提供技術指導、特價零件供應服務。對使用者的不當使用、設定、組裝、修改、或操作不良所造成的破損或傷害，本公司無法控制及負責。任何使用、設定、組裝、修改、或操作不良所造成的破損、意外或傷害，使用者應承擔全部責任。

## 2. SAFETY NOTES 安全注意事項



- Fly only in safe areas, away from other people. Do not operate R/C aircraft within the vicinity of homes or crowds of people. R/C aircraft are prone to accidents, failures, and crashes due to a variety of reasons including, lack of maintenance, pilot error, and radio interference. Pilots are responsible for their actions and damage or injury occurring during the operation or as of a result of R/C aircraft models.
- Prior to every flight, carefully check rotorhead spindle shaft screws and tail blade grip screws, linkage balls and screws, ensure they are firmly secured.
- 遙控模型飛機、直昇機屬高危險性商品，飛行時務必遠離人群，人為組裝不當或機件損壞、電子控制設備不良，以及操控上的不熟悉、都有可能導致飛行失控損傷等不可預期的意外，請飛行者務必注意飛行安全，並需了解自負疏忽所造成任何意外之責任。
- 每趟飛行前須仔細檢查，主旋翼夾座橫軸螺絲、尾旋翼夾座螺絲，以及機身各部位球頭、螺絲，確實上膠鎖緊才能升空飛行。





## LOCATE AN APPROPRIATE LOCATION 遠離障礙物及人群

R/C helicopters fly at high speed, thus posing a certain degree of potential danger. Choose a legal flying field consisting of flat, smooth ground without obstacles. Do not fly near buildings, high voltage cables, or trees to ensure the safety of yourself, others and your model. For the first practice, please choose a legal flying field. Do not fly your model in inclement weather, such as rain, wind, snow or darkness.

直昇機飛行時具有一定的速度，相對的也潛在著危險性，場地的選擇也相對的重要，請需遵守當地法規到合法遙控飛行場地飛行。務必選擇在空曠合法專屬飛行場地，並必須注意周遭有沒有人、高樓、建築物、高壓電線、樹木等等，避免操控的不當造成自己與他人財產的損壞。

請勿在下雨、打雷等惡劣天候下操作，以確保本身及機體的安全。



## NOTE ON LITHIUM POLYMER BATTERIES 鋰聚電池注意事項

Lithium Polymer batteries are significantly more volatile than alkaline or Ni-Cd/Ni-MH batteries used in RC applications. All manufacturer's instructions and warnings must be followed closely. Mishandling of Li-Po batteries can result in fire. Always follow the manufacturer's instructions when disposing of Lithium Polymer batteries.

鋰聚電池跟一般在RC使用的鹼性電池、鎳鎘電池、鎳氫電池比較起來是相對危險的。請嚴格遵守鋰聚電池說明書之使用注意事項。不恰當使用鋰聚電池，可能造成火災並傷及生命財產安全，切勿大意！

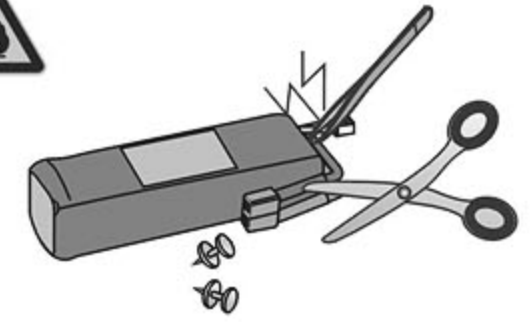

## PREVENT MOISTURE 遠離潮濕環境

R/C models are composed of many precision electrical components. It is critical to keep the model and associated equipment away from moisture and other contaminants. The introduction or exposure to water or moisture in any form can cause the model to malfunction resulting in loss of use, or a crash. Do not operate or expose to rain or moisture.

直昇機內部也是由許多精密的電子零組件組成，所以必須絕對的防止潮濕或水氣，避免在浴室或雨天時使用，防止水氣進入機身內部而導致機件及電子零件故障而引發不可預期的意外！

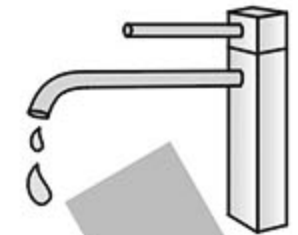

## PROPER OPERATION 勿不當使用本產品

Please use the replacement of parts on the manual to ensure the safety of instructors. This product is for R/C model, so do not use for other purpose.

請勿自行改造加工，任何的升級改裝或維修，請使用亞拓產品目錄中的零件，以確保結構的安全。請確認於產品限界內操作，請勿過載使用，並勿用於安全、法令外其它非法用途。



## OBTAIN THE ASSISTANCE OF AN EXPERIENCED PILOT 避免獨自操控

Before turning on your model and transmitter, check to make sure no one else is operating on the same frequency. Frequency interference can cause your model, or other models to crash. The guidance provided by an experienced pilot will be invaluable for the assembly, tuning, trimming, and actual first flight or unforeseen danger may happen. (Recommend you to practice with computer-based flight simulator.)

至飛行場飛行前，需確認是否有相同頻率的好手正進行飛行，因為開啟相同頻率的發射器將導致自己與他人立即干擾等意外危險。遙控飛機操控技巧在學習初期有著一定的難度，要盡量避免獨自操作飛行，需有經驗的人士在旁指導，才可以操控飛行，否則將可能造成不可預期的意外發生。(勤練電腦模擬器及老手指導是入門必要的選擇)

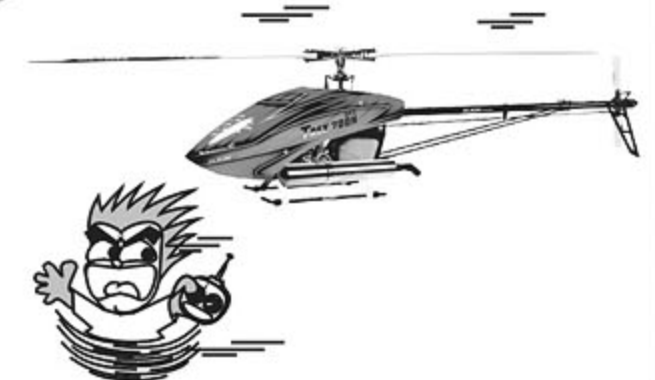

## SAFE OPERATION 安全操作

Operate this unit within your ability. Do not fly under tired condition and improper operation may cause in danger. Never take your eyes off the model or leave it unattended while it is turned on. Immediately turn off the model and transmitter when you have landed the model.

請於自己能力內及需要一定技術範圍內操作這台直昇機，過於疲勞、精神不佳或不當操作，意外發生風險將可能會提高。不可在視線範圍外進行，降落後也請馬上關掉直昇機和遙控器電源。



## ALWAYS BE AWARE OF THE ROTATING BLADES 遠離運轉中零件

During the operation of the helicopter, the main rotor and tail rotor will be spinning at a high rate of speed. The blades are capable of inflicting serious bodily injury and damage to the environment. Be conscious of your actions, and careful to keep your face, eyes, hands, and loose clothing away from the blades. Always fly the model a safe distance from yourself and others, as well as surrounding objects.

直昇機主旋翼與尾旋翼運轉時會以高轉速下進行，在高轉速下的旋翼會造成自己與他人在身體上或環境上的嚴重損傷，請勿觸摸運轉中的主旋翼與尾旋翼，並保持安全距離以避免造成危險及損壞。



## KEEP AWAY FROM HEAT 遠離熱源

R/C models are made of various forms of plastic. Plastic is very susceptible to damage or deformation due to extreme heat and cold climate. Make sure not to store the model near any source of heat such as an oven, or heater. It is best to store the model indoors, in a climate-controlled, room temperature environment.

遙控飛機、直昇機多半是以 PA 纖維或聚乙烯、電子商品為主要材質，因此要盡量遠離熱源、日曬，以避免因高溫而變形甚至熔毀損壞的可能。





**FEATURES 產品特色**

- 3Axis** 3-axis gyroscopic flybarless system to simulate the stability of mechanical flybar system, yet at the same time achieving agile 3D performance.  
3軸陀螺儀無平衡翼系統，可模擬有平衡翼系統的穩定性，更有靈活的3D性能。
- MEMS** Utilizes MEMS gyro sensors, which feature small footprint, high reliability, and excellent stability.  
採用MEMS (Micro Electro Mechanical Systems) 微機電系統技術感測器，具有體積小，可靠性高，穩定性佳的優點。
- 12bit** Sensor with 12 bit ultra high resolution, resulting in highly precise controls.  
感測器12位元，超高解析度，控制細膩精準。
- APs** Supports APS Gyro.  
支援APS陀螺儀。
- SPEKTRUM** Supports Spektrum and JR satellite receivers.  
支援SPEKTRUM與JR衛星天線。
- S.BUS** Supports Futaba S.Bus architecture.  
支援Futaba S.BUS功能。
- USB** Software upgradable through PC interface adapter.  
具備可升級程式化介面，可透過傳輸線更新軟體。
- Easy** Simplistic setup process without the need of external devices. Setup is done through 5 steps and 2 sensitivity adjustments.  
設定簡單不需額外的介面，只需五個步驟、兩個感度調整即可完成所有設定。
- Energy** Flybarless system dramatically improves 3D power output and efficiency, resulting in reduced fuel or electricity consumption.  
無平衡翼系統，可大幅降低3D大動作飛行能量消耗，提供直昇機更大的動力輸出且更加節省燃油或電力。
- Stable** Highly sensitive gyroscopic sensors combined with advanced control detection routine providing higher hovering and aerobatic stability than other flybarless system.  
高感度陀螺感測器及先進環路設計，可提供比一般平衡翼系統更佳的靜態及動態穩定性。
- CCPM** Suitable for all CCPM and mechanical mixing system.  
適用於任何比例之對稱式三伺服器CCPM系統及傳統十字盤系統。
- GOV** Built in speed governor function.  
內建定速器功能。
- T-REX 250-800** Compatible with helicopter of all sizes from T-REX 250 to T-REX 800.  
3GX Flybarless電子設備相容小型直昇機至大型直昇機T-REX250~T-REX800。
- 3.5V-8.4V** Capable to operate between 3.5V to 8.4V, compatible with high voltage servos.  
適用電壓3.5V~8.4V，支援高電壓伺服器。
- 11g** Small footprint, light weight, minimalists and reliable design.  
體積小、重量輕，構造簡單可靠，提供操控者高性能的飛行樂趣。
- RoHS** RoHS certified.  
符合RoHS限用規章。

**3GX FLYBARLESS SETUP INDICATORS 功能設定指示燈說明**

**FLYBARLESS SYSTEM SETUP MODE 無平衡翼系統設定模式**

<b>DIR</b>	<b>E.LIM</b>	<b>E.REV</b>	<b>A.LIM</b>	<b>A.REV</b>
Direct mode bypassing gyro, for mechanical travel and neutral point setup. 機械行程與中立點設定	Collective mixing type recognition and elevator endpoint settings 混控辨識及升降舵行程設定	Elevator reverse settings 升降舵正反向設定	Aileron endpoints settings 副翼行程設定	Aileron reverse settings 副翼正反向設定

**RUDDER GYRO SETUP MODE 尾舵陀螺儀設定模式**

<b>1520/760</b>	<b>DS/AS</b>	<b>NOR/REV</b>	<b>LIMIT</b>	<b>DELAY</b>	<b>Anti-torque compensation direction setting</b>
Servo frame rate settings (1520 μs and 760 μs) 寬頻1520 μs及窄頻760 μs伺服器設定	Digital/Analog servo settings 數位及類比伺服器設定	Rudder Servo Reverse settings 尾舵陀螺儀正反向設定	Rudder endpoints settings 尾舵行程設定	Rudder servo delay, and helicopter size settings 尾舵延遲量及大小直昇機模式設定	Anti-torque compensation settings 反扭力補償正反向設定



## SETUP PRE-CHECK 設定前注意事項



While using 3GX FBL system, be sure to turn off the following functions in the transmitter  
 使用3GX系統若是遙控器有下列功能時請勿開啟功能  
 \* Swash Ring \* Linkage Compensation \* Swash Mix \* Mixing \* Acceleration

1. Connect the receiver and servos to the flybarless control unit as per diagram found on page 4~5 .
  2. Digital servos must be used on cyclic to avoid damage to servos.  
 commended servo spec: minimum speed 0.08 sec/60°, torque 12kg.cm or higher.
  3. The trim must be zero when using 3GX, and should not be adjusted at anytime. If the helicopter hovering tend to one side, it means the swashplate doesn't keep horizontal when setting. Go to flybarless system "Direct mode bypassing gyro, for mechanical travel and neutral point setup" to adjust the level of the swashplate and then re-complete the setup.
  4. When the 3GX Flybarless system is installed for the first time, a few simple setup steps and fly tests need to be performed in the flybarless setup mode. these steps need to be performed only during initial setup, and does not need to be repeated for sub-sequent flights. Just power up the system normally, check the proper servo operations, and fly. The initial setup procedure only need to be repeated after software upgrade, pitch range reset, or subtrims are added in the transmitter.
1. 將接收器及伺服器依接線示意圖連接 (請參照第4~5頁)。
  2. 十字盤必須安裝數位伺服器, 否則會造成伺服器損毀。 建議規格: 速度0.08秒/60°以內; 扭力12kg.cm以上。
  3. 進入設定前必須將遙控器的外微調歸零, 飛行時不可調整外微調, 若直昇機停懸時偏向某一邊移動, 表示設定時十字盤未保持水平, 請進入無平衡翼系統"機械行程與中立點設定", 調整十字盤呈水平後, 重新完成設定。
  4. 第一次安裝3GX Flybarless無平衡翼系統時, 必須進入無平衡翼設定模式, 進行幾項簡易的安裝設定與飛行測試, 完成後即不須再進入此設定模式, 只要正常開機, 檢查伺服器動作正確後即可飛行; 除非要更新程式、重設螺距或有更動遙控器內微調(sub.trim)時, 必須進入設定模式重設無平衡翼系統。

## 3GX CONNECTIVITY METHOD 3GX接線方式

### METHOD 1: STANDARD RECEIVER CONNECTIVITY METHOD 方式一: 傳統接收器接線法

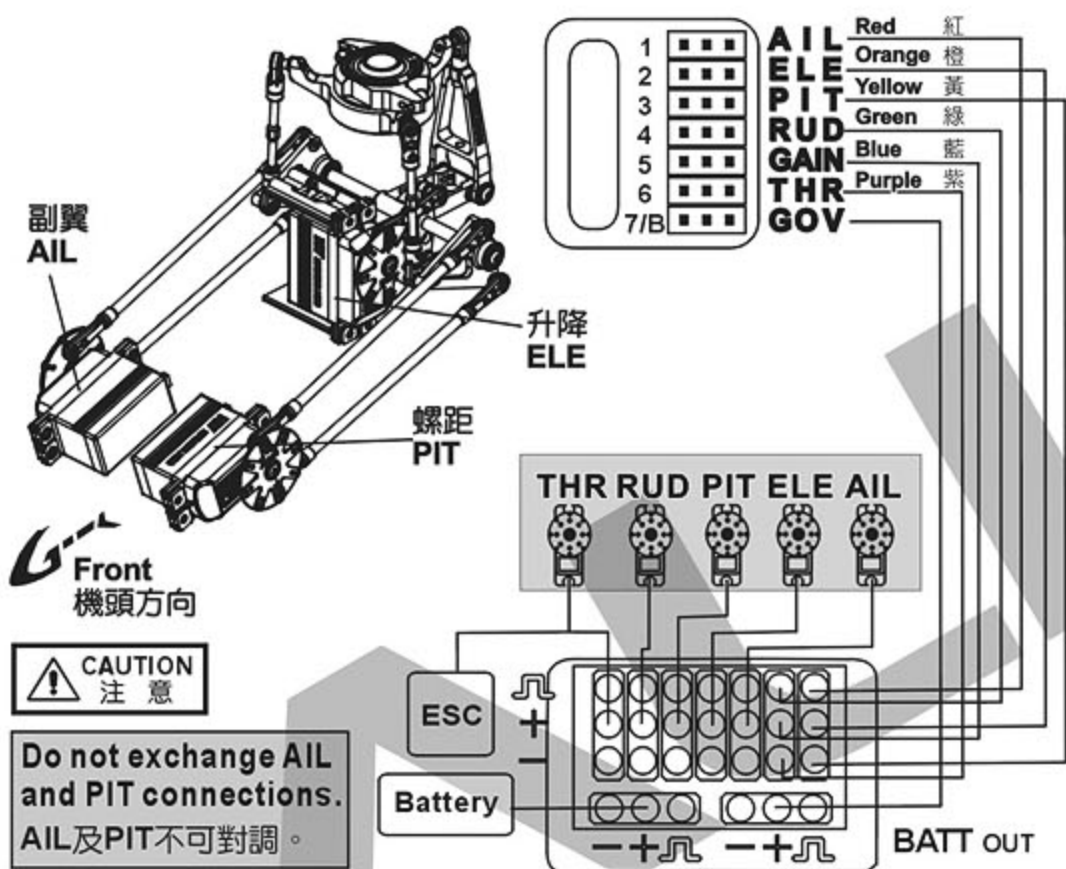

1. Connect all wires as shown in diagram. Receiver and 3GX wires are color coded to distinguish the different connection channels. Care should be taken to ensure proper wire color to channel connection.
2. While using the speed controller that not including BEC, you need to connect the BEC power with 3GX "BATT" port.
3. Receiver power is achieved by connecting the 3GX "S.BUS/BIND" port to the ch7 or BATT port on receiver using supplied signal wire.
4. To avoid damage to servos, only digital servos should be used for swashplate. Recommended spec: 0.08s/60° or faster, with 12 Kg or higher torque.
5. 3GX has built in speed governor function which can be utilized by purchasing the optional speed sensor. Governor setting is done through channel 7 on the receiver.

1. 請依照圖示進行接線, 接收器與3GX的接線使用不同的顏色來區分不同的通道, 接線時請注意各顏色所對應的通道。
2. 使用無BEC輸出的調速器時, 須額外由3GX的"BATT"孔位接入BEC電源。
3. 接收器電源請以隨附的訊號線由3GX的"S.BUS/BIND"孔位接至第七通道或BATT通道。
4. 十字盤必須安裝數位伺服器, 否則會造成伺服器損毀。 建議規格: 速度0.08秒/60°以內; 扭力12kg以上。
5. 3GX內建定速器功能, 可另購定速器感知器使用, 轉速設定由接收器的第七通道設定。

### METHOD 2: FUTABA S.BUS CONNECTIVITY METHOD 方式二: Futaba S.BUS接線法

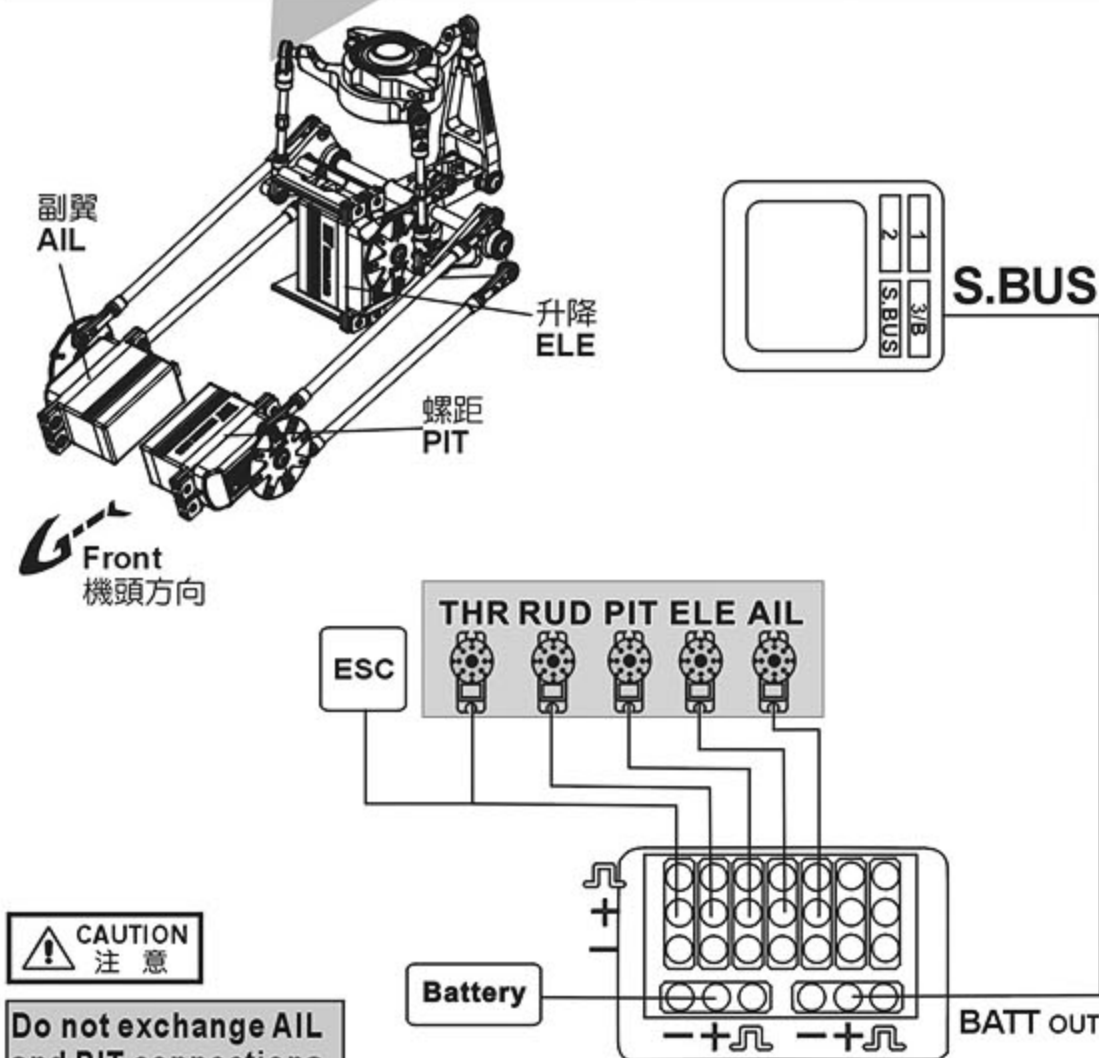

1. For Futaba S.BUS receivers, connect wires as shown in diagram.
2. While using the speed controller that not including BEC, you need to connect the BEC power with 3GX "BATT" port.
3. Receiver power is supplied through S.BUS signal wire connected to 3GX's "S.BUS/BIND" port.
4. The default channel/function mapping when using S.BUS are:  
 (1)AIL (2)ELE (3)THR (4)RUD (5)GAIN (6)PIT (7)GOV

1. 具備S.BUS功能的Futaba接收器, 請依照圖示進行接線。
2. 使用無BEC輸出的調速器時, 須額外由3GX的"BATT"孔位接入BEC電源。
3. 接收器電源共同由S.BUS 訊號線接至3GX的"S.BUS/BIND"孔位。
4. 使用S.BUS功能時, 內部通道已指定為:  
 (1)AIL (2)ELE (3)THR (4)RUD (5)GAIN (6)PIT (7)GOV



If channel (3) is set as PIT and channel (6) set as THR on transmitter, Such as 8FG, 12Z, 14MZ, and etc, please reprogram the transmitter to utilize channe (3) as THR and channe (6) as PIT.

若所使用的遙控器內部指定(3)通道為PIT (6)通道為THR時, 例如8FG、12Z、14MZ等, 請更改遙控器上的設定為(3)通道 THR (6)通道 PIT。

5. To avoid damage to servos, only digital servos should be used for swashplate. Recommended spec: 0.08s/60° or faster, with 12Kg or higher torque.
6. 3GX has built in speed governor function which can be utilized by purchasing the optional speed sensor. Governor setting is done through channel 7 on the receiver.
5. 十字盤必須安裝數位伺服器, 否則會造成伺服器損毀。 建議規格: 速度0.08秒/60°以內; 扭力12kg以上。
6. 3GX內建定速器功能, 可另購定速器感知器使用, 轉速設定由接收器的第七通道設定。



## METHOD 3: JR/SPEKTRUM SATELLITE CONNECTIVITY METHOD 方式三:JR/SPEKTRUM衛星天線接線法

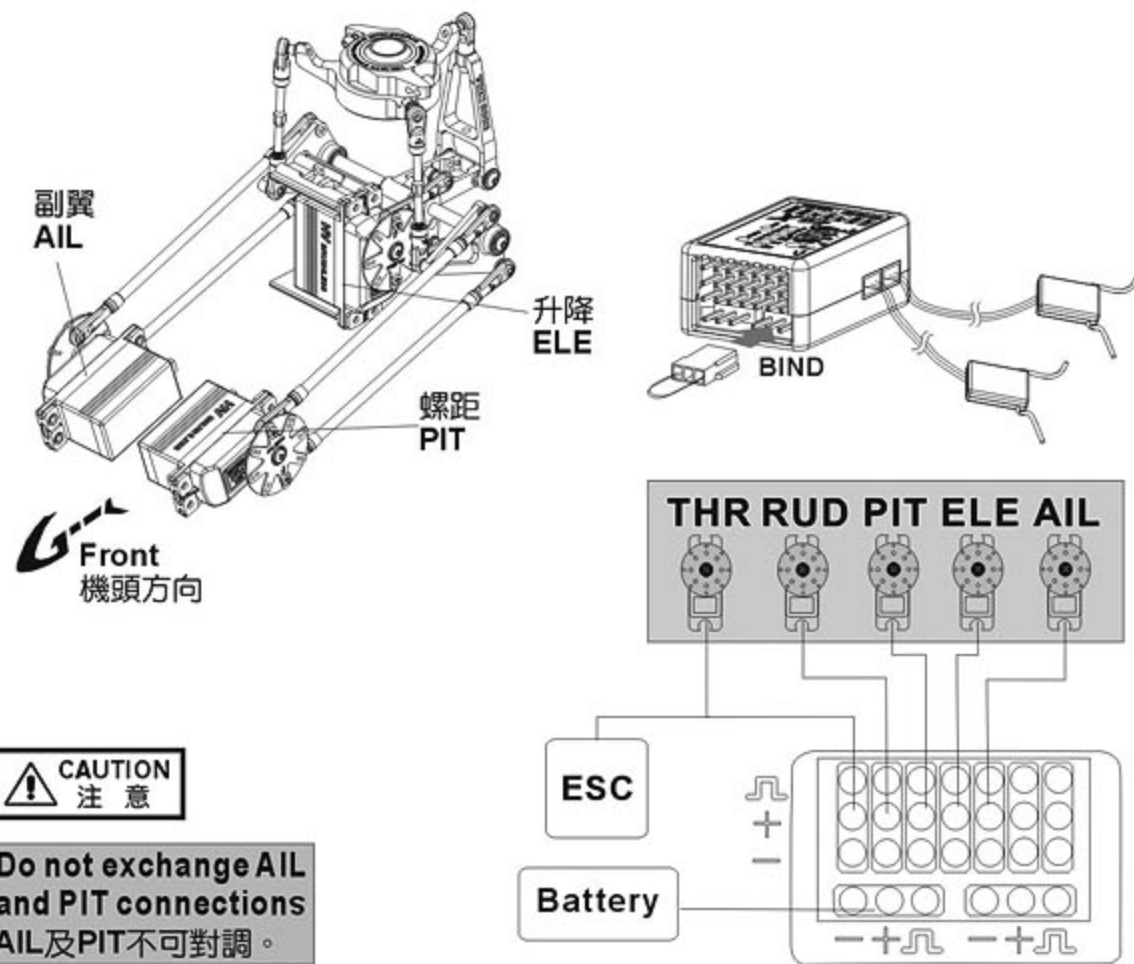

1. For JR or Spektrum satellite receivers, connect wires as shown in diagram.
2. While using the speed controller that not including BEC, you need to connect the BEC power with 3GX "BATT" port.
3. To avoid damage to servos, only digital servos should be used for swashplate. Recommended spec: 0.08s/60° or faster, with 12Kg or higher torque.
4. 3GX has built in speed governor function which can be utilized by purchasing the optional speed sensor. Governor setting is done through channel 7 on the receiver. Channel 5/GEAR controls RPM of speed governor, channel 7/AUX2 controls rudder gyro gain. For radios with less than 6 channels, please use the standard receiver connectivity method.
5. For radios with less than 6 channels, channel 5/GEAR is used for rudder gyro gain. Speed governor cannot be used. For safety concern, two satellite receives should be used, with each antenna perpendicular (90 degrees) from each other. A satellite receiver should be installed on each side of the frame, separate by minimum distance of 5cm.
6. Should both satellite receivers loose connectivity during flight, LED1 ~ LED5 will flash continuously as warning. A single power cycle of the system will not clear this error. The system need to be power cycled the second time to reset.

7. default channel/function mapping when using satellite receiver are:  
(1)THR (2)AIL (3)ELE (4)RUD (5)GOV (6)PIT (7)GAIN

1. 請依照圖示進行接線，3GX支援Spektrum與JR系統衛星天線。
2. 使用無BEC輸出的調速器時，須額外由3GX的"BATT"孔位接入BEC電源。
3. 十字盤必須安裝數位伺服器，否則會造成伺服器損毀。建議規格：速度0.08秒/60°以內；扭力12kg以上。
4. 3GX內建定速器功能，可另購定速器感知器使用。七動及七動以上遙控器(5)GEAR控制定速器轉速，(7)AUX2控制尾舵陀螺儀感度。六動以下遙控器請使用傳統接線方式。
5. 為安全起見，請盡量安裝兩個衛星天線，兩個衛星天線角度除必須呈90度之外，且須安裝於機身兩側，相隔至少5公分以上。
6. 如果飛行途中有兩個衛星天線同時失連的情形，LED1~LED5會持續閃爍警告，在此情形下就算重新開機，LED1~LED5會持續閃爍而無法開機，必須再重新開機一次，才可正常運作。
7. 使用衛星天線接線時，內部通道已指定為：  
(1)THR (2)AIL (3)ELE (4)RUD (5)GOV (6)PIT (7)GAIN

### CAUTION 注意

1. Do not mix satellite receivers of different makes.
2. Even under correct startup sequence, if transmitter is powered off first, LED1~LED5 will also flash. Thus the receiver should always be powered off before the transmitter.
3. 3GX supports satellite receiver models currently available on the market. Should new receiver version comes out with compatibility issues, firmware will be updated to resolve any incompatibility that may arise.
1. 不同廠牌的衛星天線請勿交叉對頻。
2. 正常開機的情況下，如果先關發射機，也會發生LED1~LED5持續閃爍情況，所以請養成先關接收機，再關發射機的良好習慣。
3. 如有新型號衛星天線產生不相容情形，將以韌體更新方式解決。

## FAILSAFE(LAST POSITION HOLD) 失控保護(保留最後指令)

When helicopter lost connectivity with your radio under this setting, all channels will hold at the last command position, except throttle channel which goes to a preset position.

1. Push throttle stick to the desired fail safe position.
2. Plug the binding plug into 3GX's BIND port, and perform radio binding steps.
3. After successful binding, do not power off the 3GX, unplug the binding plug and allow 3GX to enter initializing process. The last position hold function will be active after the 3GX initializes.
4. Test Method: Power off transmitter. The throttle channel should move to preset position, while all other channels should hold in their last position.

在此模式下，若您的直昇機與遙控器失連，除油門頻道為預設位置，其餘頻道皆為最後指令位置。

1. 將油門搖桿放置於您所需要的預設安全位置
2. 將對頻接頭插在3GX的BIND插座，執行與遙控器的對頻動作。
3. 與遙控器完成對頻動作後，不要關閉3GX電源，先將對頻接頭拔除，3GX會進入開機狀態，待3GX開機完成後，即完成保留最後指令設定。
4. 測試方法：將遙控器關機，除了油門頻道為預設安全位置外，其餘頻道都為失連前的最後指令位置。

### CAUTION 注意

When using DSMX remote receiver, need to press 3GX SET bottom first, then turn on the power and start binding process.  
如果使用 DSMX 衛星天線，請先按著 3GX SET 鍵，再開啟電源對頻。

## FAILSAFE (PRE-SET POSITION HOLD) 失控保護(回復預設值)

When helicopter lost connectivity with your radio under this setting, all channels will move to the pre-set position.

1. Plug the binding plug into 3GX's BIND port, and power up the 3GX. After the rapid flash of satellite's LEDs, pull the binding plug off.
2. Power up radio transmitter, and perform radio binding steps. After radio is bound, LED on the satellite antennas will end the rapid flash, following by slower flash.
3. Move the transmitter sticks to the desired failsafe position while the LED is flashing in slower mode.
4. Satellite antenna's LED will lit up after 5 seconds, and 3GX goes through initializing process. The failsafe position will be set after the 3GX initializes.

在此模式下，若您的直昇機與遙控器失連，所有頻道為預設安全位置。

1. 將對頻接頭插在3GX的BIND插座，先開啟3GX電源，待衛星天線上LED快速閃爍後，將對頻接頭拔除。
2. 開啟遙控器電源，執行與遙控器的對頻動作，對頻完成瞬間，衛星天線上LED會由快速閃爍狀態熄滅，之後再亮起改為慢速閃爍。
3. 在慢速閃爍狀態時，將遙控器上的所有搖桿放置於您所需要的預設安全位置。
4. 5秒後衛星天線LED燈為恆亮，3GX進入開機狀態，待3GX開機完成後，即完成失控保護設定。
5. 測試方法：將遙控器關機，所有頻道為預設安全位置。

### CAUTION 注意

When using DSMX remote receiver, need to press 3GX SET bottom first, then turn on the power and start binding process.  
如果使用 DSMX 衛星天線，請先按著 3GX SET 鍵，再開啟電源對頻。



# FLYBARLESS SYSTEM INITIAL SETUP STEPS 無平衡翼系統設定

## 1. DIR : DIRECT MODE TO BYPASS GYRO FOR MECHANICAL TRAVEL AND NEUTRAL POINT SETUP

DIR機械行程與中立點設定模式

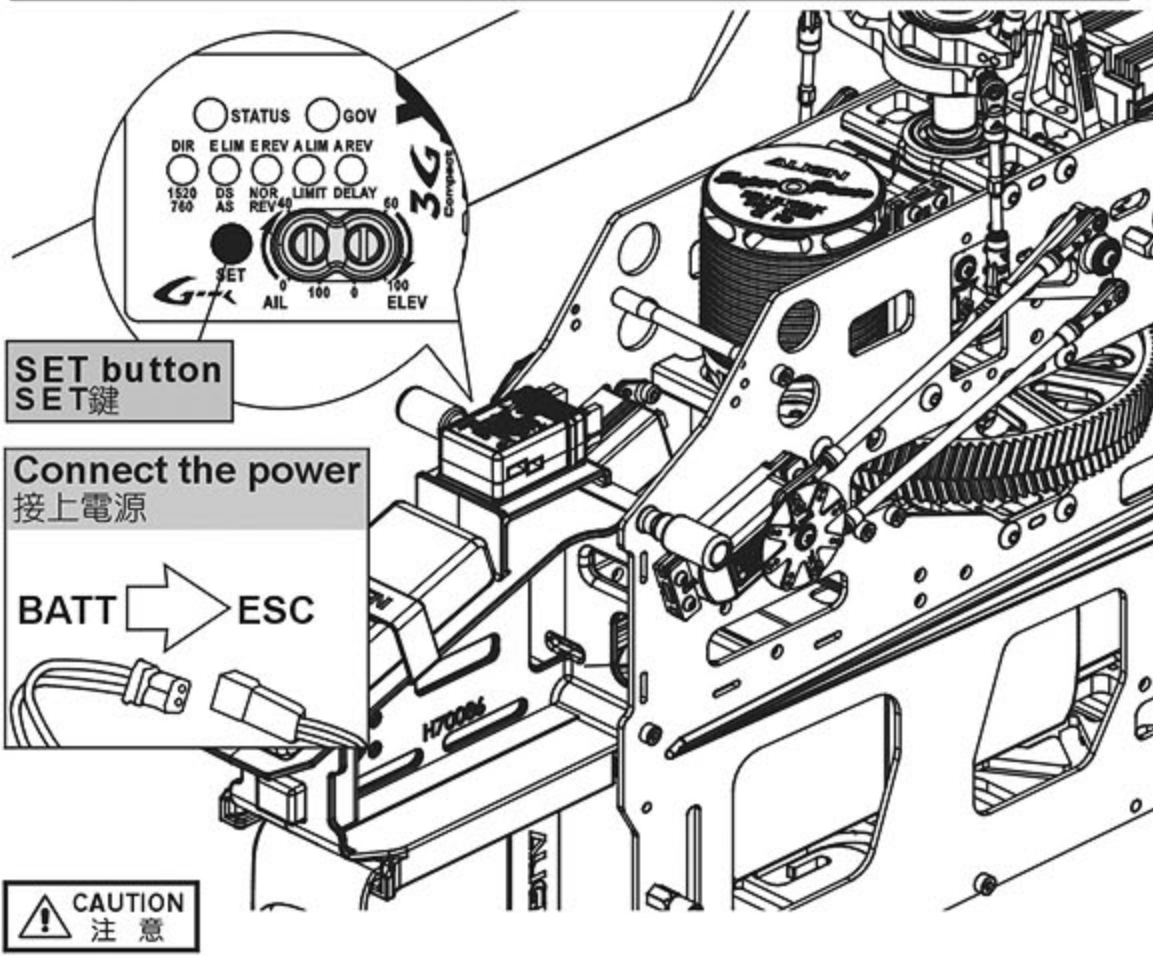

## STEP1.1 : ENTER THE DIR SETTINGS

步驟1.1 : 進入DIR設定

Press and hold the SET button while powering up the receiver. Release the button when LED 1-5 begin to cycle. Press power cycle to enter DIR mode. The DIR green LED will light up indicating the gyro has been bypassed for neutral and mechanical travel range setup.

按下"SET"鍵不放，並將接收器電源開啟，接著LED1~5(DIR~A.REV)會循序亮起，此時即可以放開按鍵(註)，"DIR"綠燈亮起，則進入3GX Flybarless機械行程與中立點設定模式。

Note: If pressed for more than 2 seconds, 3GX will enter 3GX throttle calibration mode. Re-power and enter DIR setting.

註：若按壓時間超過2秒，3GX會進入3GX油門行程校正模式，請重開電源進入DIR設定。

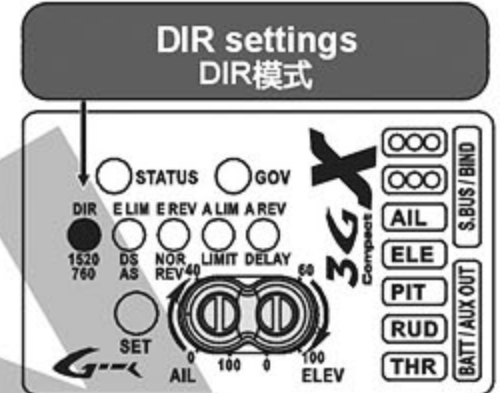

1. When entering setup mode during power up, 3GX will initiate startup process. Do not move the helicopter at this time, otherwise swashplate will be tilted after start up. Should this occurs, restart the setup mode.
2. If 3GX was to be mounted inverted, please enter connect anti-torque compensation section and set it as "reverse" (STATUS LED turns red); to avoid the effect of the performance of gyro lock.

1. 當接上電源進入設定模式的同時，3GX會啟動初始化的程序，此時請勿移動機身，以免造成開機後十字盤傾斜，發生此狀況時請重新進入設定模式。
2. 選擇3GX面板朝下的安裝方式時，請進入設定選項中的反扭力補償設定，並將反扭力補償設為'反向'(STATUS燈為紅燈)，以免影響陀螺儀鎖定效果。



## TRANSMITTER FUNCTION TO SERVO MAPPING 遙控器對應伺服器關係

### STEP1.2 : SWASHPLATE FUNCTION CHECK

步驟1.2 : 十字盤作動確認

Verify the correct swashplate movements for PIT, AIL, and ELE inputs. 確認十字盤作動 PIT、AIL、ELE 是否正確。

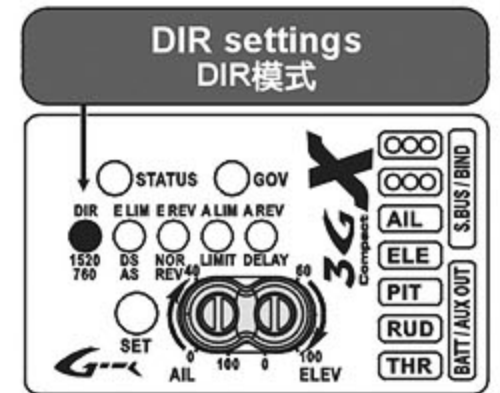
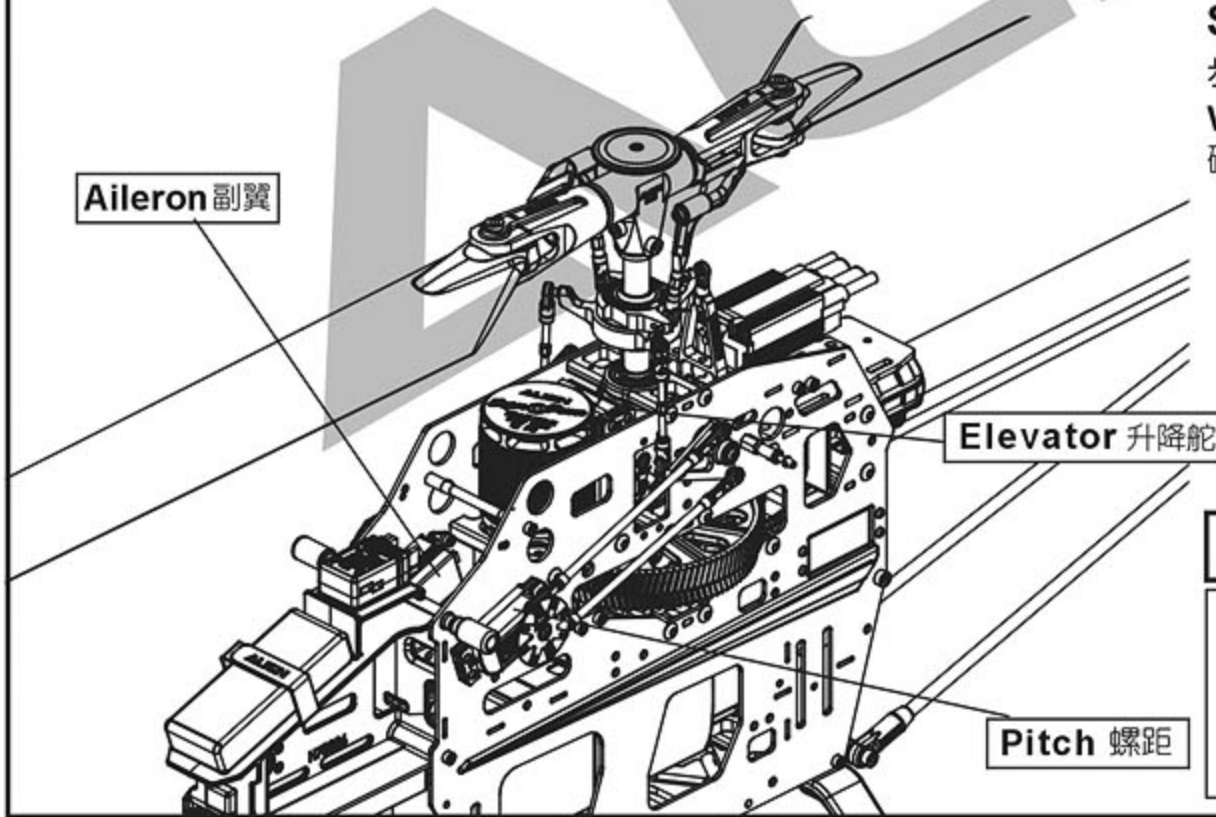

CAUTION 注意

In case of incorrect servo movement or no movement at all, please check for proper connection between 3GX flybarless connection to servos, as well as proper setup on transmitter. 若作動錯誤或伺服器無動作，請檢查3GX Flybarless 伺服器訊號線接線以及遙控器設定是否正確。

### STEP1.3 : MECHANICAL SETUP

步驟1.3 : 機械結構設定

Adjust the servo neutral point and main blade pitch. 請調整伺服器中立點、主旋翼角度(如圖示)。

CAUTION 注意

Pay extra attention to these setup steps. Incorrect neutral points will affect flight stability, and worse lead to loss of control.

本步驟請確實設定，若中立點不正確，不但影響飛行穩定性，更可能造成失控的危險。

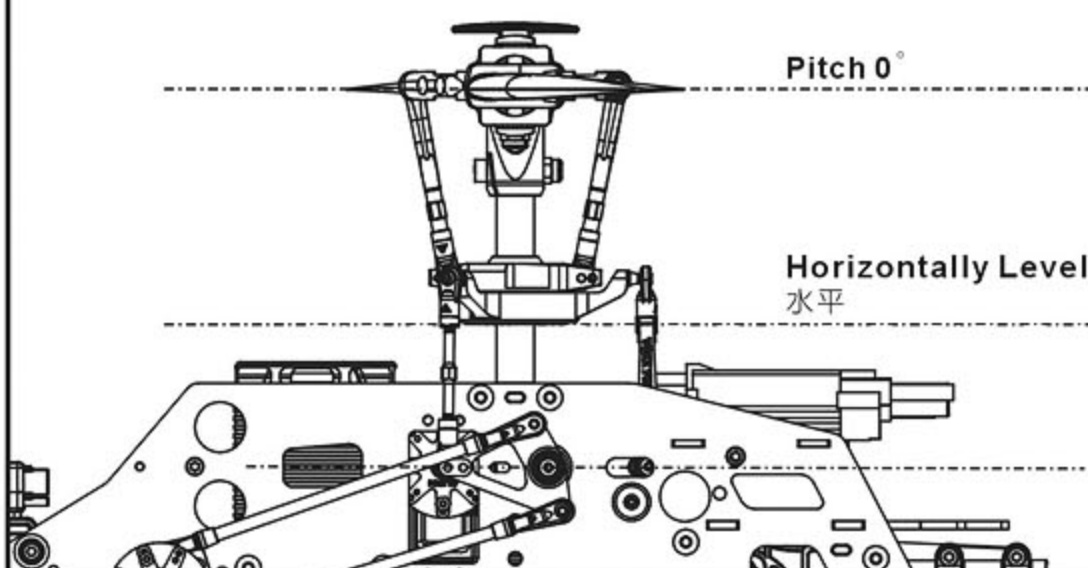

Adjust subtrims on transmitter so servo horn is horizontally level 伺服器中立點水平(調整遙控器的Subtrim)



### STEP1.4 : COLLECTIVE PITCH SETUP

步驟1.4 : 主旋翼螺距(集體螺距)設定

Adjust the maximum collective pitch using the transmitter's swash plate mixing function (pitch swash AFR). Recommended pitch range  $\pm 12^\circ$ , maximum pitch range for advanced pilot shall not exceed  $\pm 14^\circ$ . 建議螺距設定  $\pm 12^\circ$ ，高階使用者不超過  $\pm 14^\circ$  為限。



Do not adjust individual servos endpoints through the servo ATV/AFR function, use only swashplate mixing adjustments. Should any changes made to the endpoints or subtrims on the transmitter in the future, the flybarless system initial setup must be performed again.

CCPM系統調整行程量時，須從遙控器Swash十字盤混控比率 (Pitch swash AFR) 調整，勿去調整個別伺服器的ATV行程量。爾後遙控器的內微調如有變更，必須重新進行Flybarless各項設定。

While using 3GX FBL system, be sure to turn off the following functions in the transmitter

使用3GX系統若是遙控器有下列功能時請勿開啓功能

- \* Swash Ring
- \* Linkage Compensation
- \* Swash Mix
- \* Mixing
- \* Acceleration

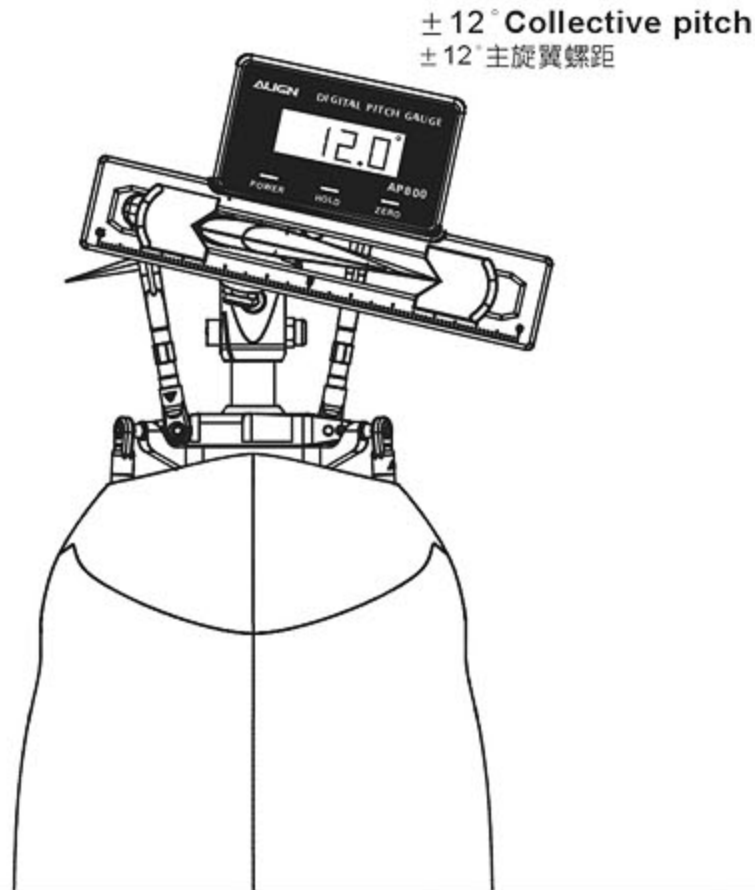
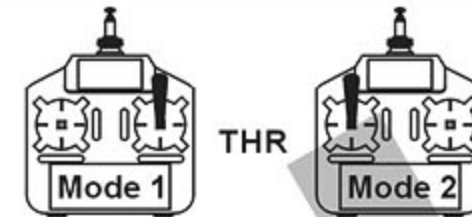

$\pm 12^\circ$  Collective pitch  
 $\pm 12^\circ$  主旋翼螺距

### STEP1.5 : CYCLIC PITCH SETUP

步驟1.5 : 循環螺距設定

Swashplate cyclic pitch setting: With the main blades parallel to helicopter body, throttle stick positioned where main pitch is 0 degrees, move aileron stick all the way to the right, adjust the AIL mixing ratio within radio's SWASH menu so the main blade pitch is the factory recommended value  $\pm 8$  degrees. The ELE mixing ratio in SWASH menu can be set to the same value as AIL.

十字盤循環螺距設定：主旋翼方向與機體方向相同，油門搖桿置於主旋翼角度0度的位置不動，撥動副翼搖桿至最右，調整遙控器Swash中AIL比率，使主旋翼的攻角設定為原廠建議值  $\pm 8$  度，搖控器Swash ELE比率請設定為與AIL比率相同即可。

If adjustments is needed for aileron and elevator roll rate, it can be done through 3GX interface's flight mode settings, or through 3GX PC interface.

若需調整副翼及升降滾轉速率時，可由3GX面板進入3GX飛行特性設定或透過3GX電腦介面調整。



Adjustments to the CCPM servos endpoints should be done through transmitter's swashplate mixing function (AIL swash AFR). Do not adjust individual servos endpoints through the servo ATV/AFR function. Should any changes made to the endpoints or subtrims on the transmitter in the future, the flybarless system initial setup must be performed again.

CCPM系統調整行程量時，從遙控器Swash十字盤混控比率做調整，勿去調整個別伺服器的ATV行程量。爾後遙控器內微調如有變更，必須重新進行Flybarless各項設定。

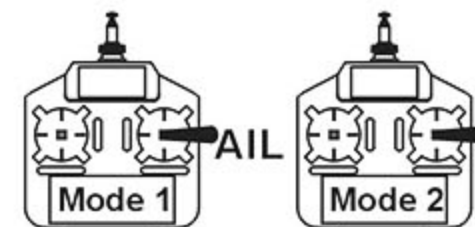

$\pm 8^\circ$  Cyclic pitch  
 $\pm 8^\circ$  循環螺距

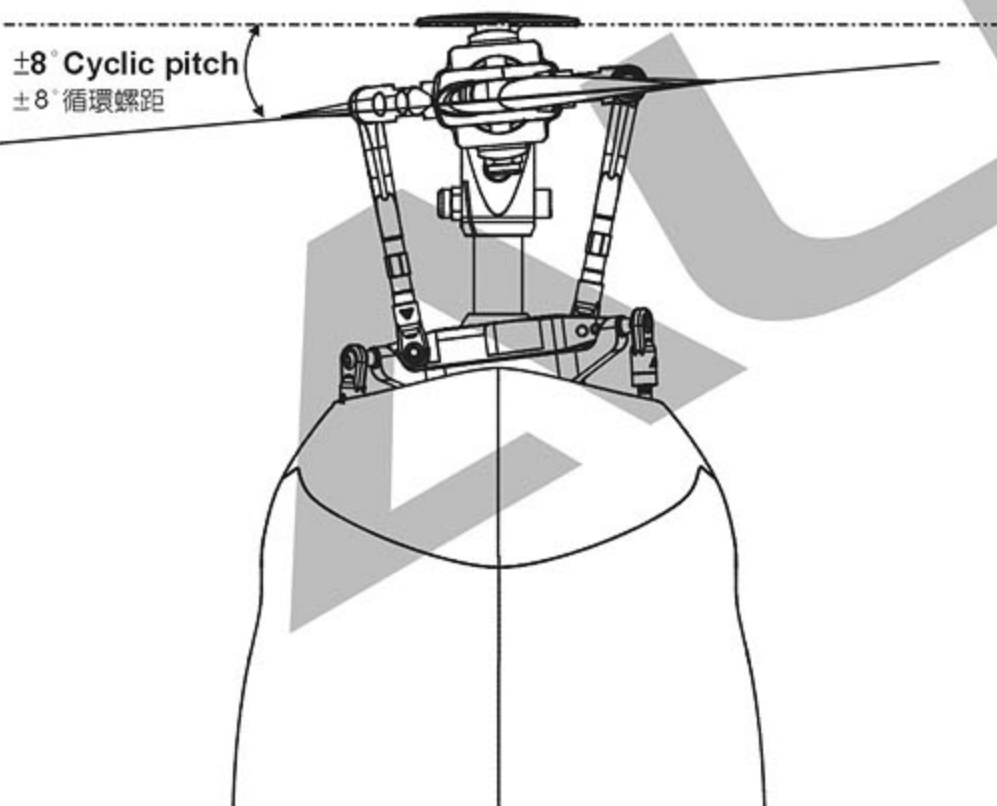

Example : cyclic pitch of  $8^\circ$  :  
Futaba 12ZH with three BL 700H's  
AILeron swash AFR : 53% ( $8^\circ$ )  
Elevator swash AFR : 53%  
Pitch swash AFR : 37% ( $\pm 12^\circ$ )

以循環螺距設定  $8^\circ$  為例：  
Futaba 12ZH 搭配 BL 700H x3  
AILeron swash AFR : 53% ( $8^\circ$ )  
Elevator swash AFR : 53%  
Pitch swash AFR : 37% ( $\pm 12^\circ$ )

### STEP2.1 : ENTERING E.LIM SETUP MODE

步驟2.1 : 進入E.LIM設定

While keeping swashplate level and main pitch at zero degrees, press the SET button to register the neutral point and enter E.LIM setup mode. The E.LIM LED will lit up after DIR turns off.

保持十字盤為水平、旋翼角度為零度的狀態下，接著按下"SET"鍵DIR燈將熄滅，E.LIM燈將會亮起，進入"E.LIM升降舵行程量"設定模式。



The throttle stick position where main pitch is 0 degree must be maintained through this setup process.

油門搖桿須置於主旋翼角度0度的位置，不可再移動。

### 2.E.LIM SWASHPLATE MIXING TYPE RECOGNITION AND ELEVATOR ENDPOINT SETUP :

E.LIM十字盤混控辨識及升降舵行程量設定模式：

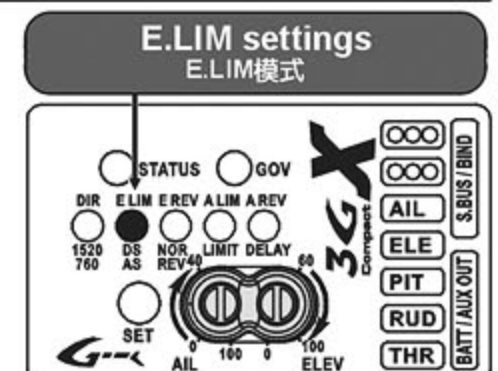
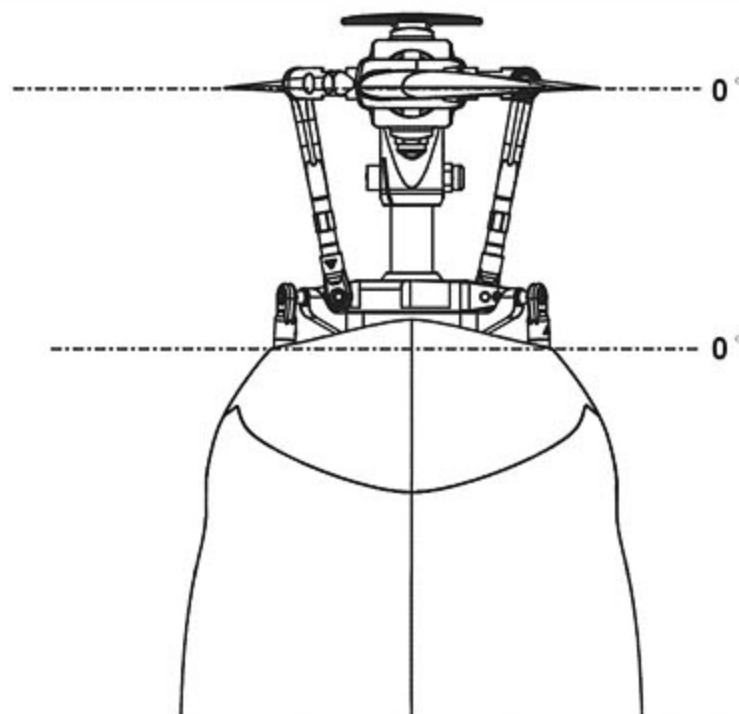



## STEP2.2 : SWASHPLATE MIXING TYPE RECOGNITION AND ELEVATOR ENDPOINT SETUP

步驟2.2 : 十字盤混控辨識及升降舵行程量設定

With all channels stationary, move the transmitter elevator stick forward, and then back to center position. This completes the swashplate mixing type recognition process.

The control unit will determine the CCPM mixing ratio or traditional mechanical mixing maximum elevator endpoints.

將遙控器升降舵推至最前方(請勿動到其他舵面動作), 再將升降舵搖桿放回中間位置, 完成此模式設定。

讓3GX Flybarless解算CCPM混控比例或傳統十字盤模式及前後可用行程。

**CAUTION**  
注意

Throttle stick position where main pitch is 0 degree must be maintained through this setup process.  
油門搖桿須置於主旋翼角度0度的位置, 不可再移動。

Throttle stick must be maintained  
油門搖桿固定

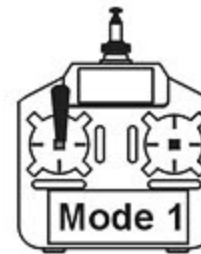

ELE

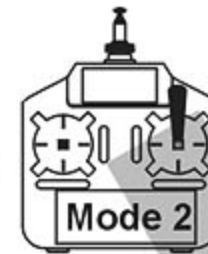

E.LIM settings  
E.LIM模式

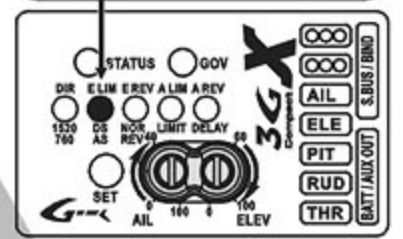

## 3. E.REV ELEVATOR REVERSE SETUP MODE

E.REV升降舵陀螺儀正反向設定模式

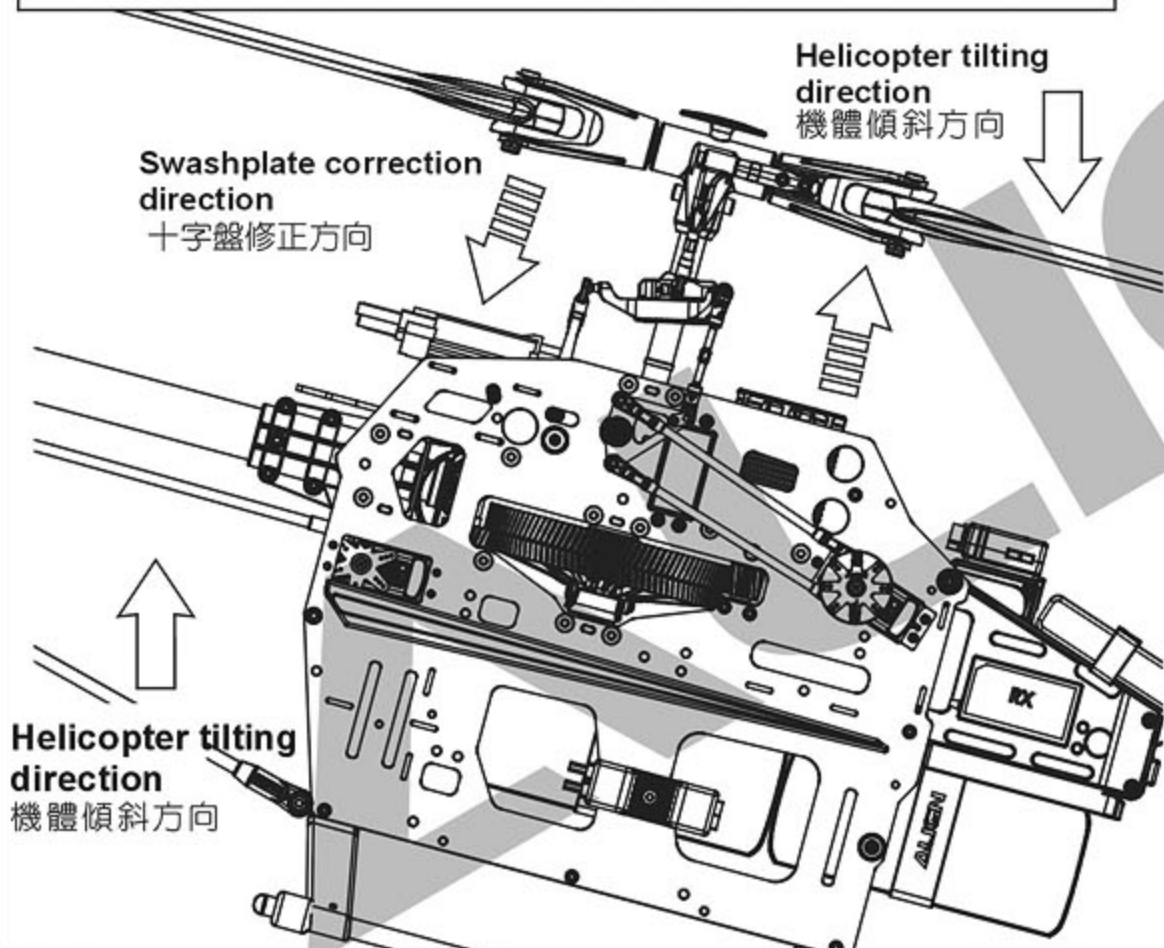

Press the SET button to enter E.REV setup mode. The E.REV LED will lit up after E.LIM turns off. This setup mode sets the elevator gyro direction

1. Tilt the helicopter forward as shown in diagram, and check if swashplate is tilting correctly toward the back.
2. If the swashplate is tilting at the wrong direction, move the transmitter elevator stick until STATUS LED changes color, and re-check the swashplate tilting direction.

接著按下"SET"鍵, 讓設定模式進入"E.REV 升降舵陀螺儀正反向"設定模式, 此時E.LIM燈熄滅, E.REV燈亮起, 此模式設定升降舵陀螺儀修正方向。

1. 如圖示, 將機身向前傾確認十字盤的修正方向是否正確。
2. 如果十字盤方向修正錯誤, 請撥動升降舵搖桿改變STATUS燈顏色後, 再次確認十字盤修正方向是否正確。

E.REV settings  
E.REV模式

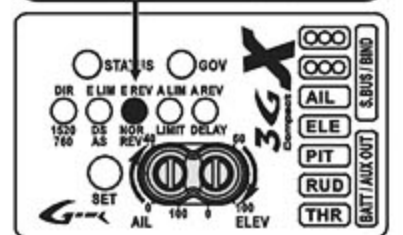

## 4. A.LIM AILERON ENDPOINTS SETUP

A.LIM副翼行程量設定模式

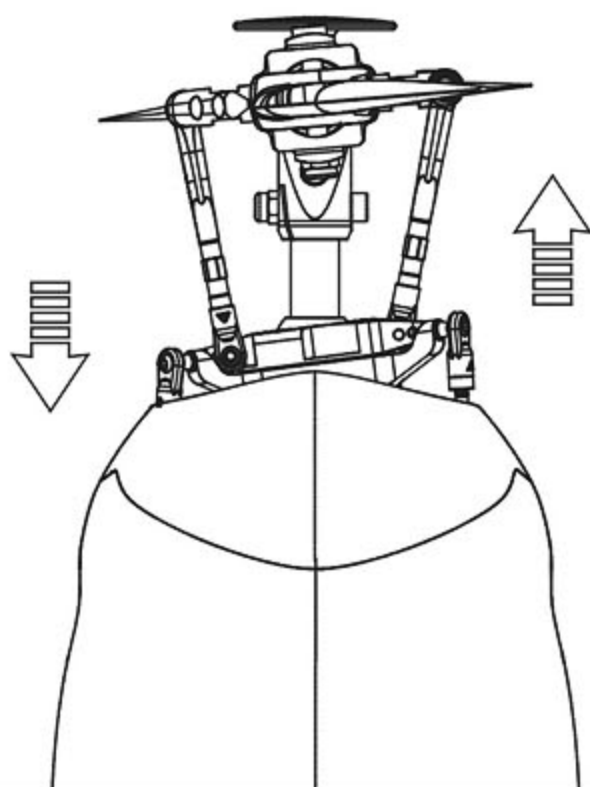

Press the SET button to enter A.LIM setup mode. The A.LIM LED will lit up after E.REV turns off. With all channels stationary, move the transmitter aileron stick to the right, and then back to center position. This completes the aileron endpoint setup process. The control unit will determine the maximum aileron endpoints

接著按下"SET"鍵, 讓設定模式進入"A.LIM副翼行程量"設定模式, 此時E.REV燈熄滅, A.LIM燈亮起。將副翼搖桿向右推到底, 完成後將搖桿置中, 完成此模式設定, 讓3GX Flybarless解算副翼可用行程。

**CAUTION**  
注意

The throttle stick position where main pitch is 0 degree must be maintained through this setup process.  
油門搖桿須置於主旋翼角度0度的位置, 不可再移動。

Throttle stick must be maintained  
油門搖桿固定

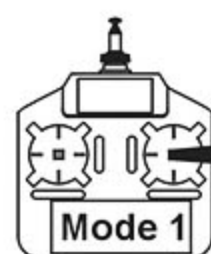

AIL

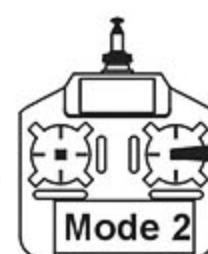

A.LIM settings  
A.LIM模式

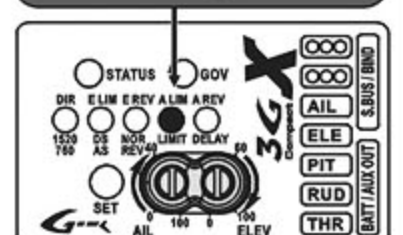



## 5. A.REV AILERON REVERSE SETUP MODE

A.REV 副翼陀螺儀正反向設定模式

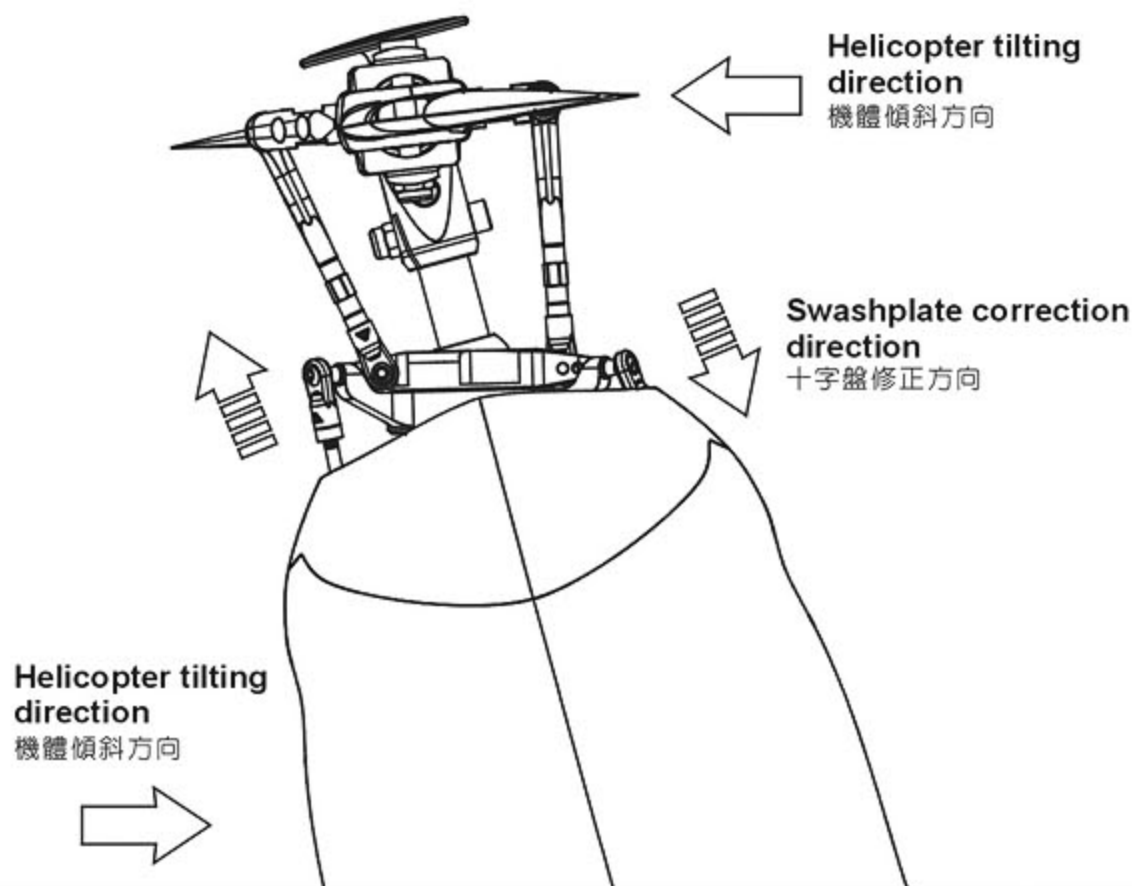

Press the SET button to enter A.REV setup mode. The A.REV LED will lit up after A.LIM turns off. Tilt the helicopter right as shown in diagram, and check if swashplate is tilting correctly toward the left. If the swashplate is tilting at the wrong direction, move the transmitter aileron stick until STATUS LED changes color, and re-check the swashplate tilting direction. Press the SET button again, and the control unit will restart with all LED's flashing. This completes the flybarless portion of the setup process.

接著按下"SET"鍵，讓設定模式進入"A.REV副翼陀螺儀正反向"設定模式，此時A.LIM燈熄滅，A.REV燈亮起。此模式設定副翼陀螺儀修正方向，如果將直昇機往右傾，3GX Flybarless應將十字盤向左傾修正，如果反向，可向左或向右推動副翼搖桿，變換"STATUS"不同顏色燈號，更換陀螺儀修正方向。接著按下"SET"鍵完成無平衡翼系統設定，所有LED將閃動，重新開機。



3GX Flybarless system must remain stationary during startup. Do not move the helicopter until the swashplate jumps up and down slightly 3 times, indicating the completion of initialization.

3GX Flybarless 開機時會進入初始化狀態，此時請勿移動機身，當初始化完成後，十字盤會保持水平上下小幅跳動3次，表示開機完成。

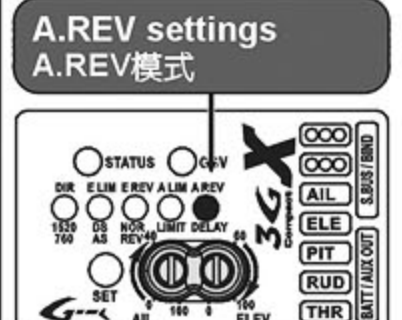

## 3GX THROTTLE CALIBRATION 3GX遙控器油門行程校正



While setting throttle calibration, reset throttle curve and pitch curve to default 0-50-100.

遙控器油門行程校正時，先將油門/螺距曲線回復到預設0 50 100設定。

Throttle/Pitch curve  
油門/螺距曲線

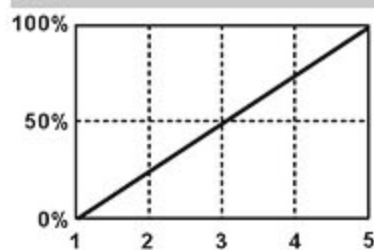

Press 3GX SET button  
按著3GX SET鍵不放

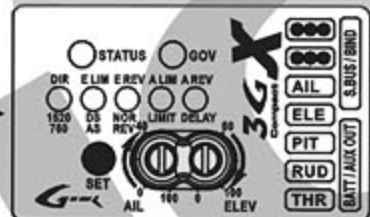

Turn on the receiver power  
開啓接收機電源

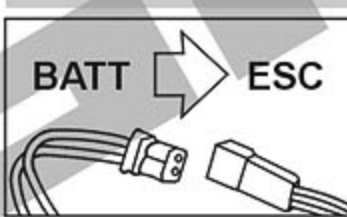

LED on 3GX panel all light up  
讓3GX面板上LED依序亮起至全亮

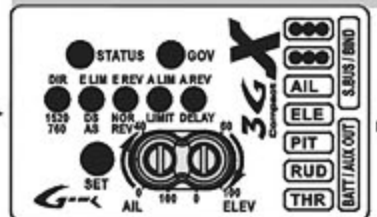

Release SET button  
放開SET鍵

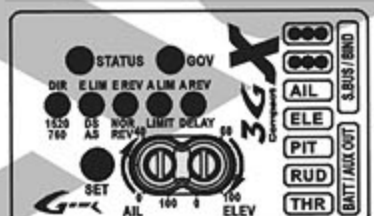

Move the throttle stick from lowest to highest point  
將油門搖桿從最低點推至最高點位置

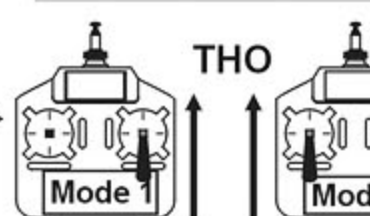

After finish the setup, red and green LED start flashing and 3GX restarts  
設定完成後，紅綠燈閃爍，3GX重新開啓

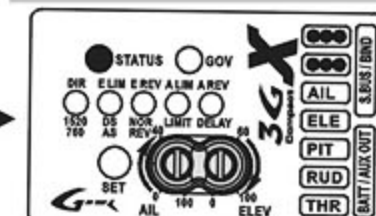

Take off the receiver power  
關閉接收機電源

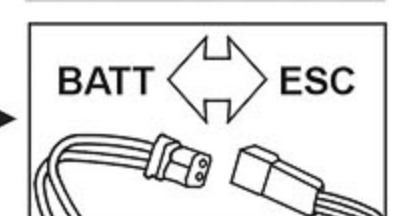

## FLIGHT MODE SETTING 飛行特性設定

Operation Instruction

1. With 3GX in operation mode, push rudder to left or right, and press the SET button for about a second.
2. After entering setting mode, the STATUS LED will flash specific number of times to indicate specific settings.
3. During setting process, LED1 to 5 indicate the rate of setting; flashing LED represents 10%, while steady lit LED represents 20%. For example, if LED1 and LED2 are steady lit with LED3 flashing, the set rate is  $2 \times 20 + 10 = 50\%$ .

操作說明

1. 在3GX運作狀態中將尾舵搖桿扳至左邊或右邊不放，接著按SET鍵約一秒。
2. 進入設定後STATUS的燈號會以閃爍的次數代表所進入的選項。
3. 在設定過程中LED1~5代表設定值，LED閃爍代表10%，LED恆亮代表20%，例如LED1~LED2全亮，LED3閃爍，設定值為 $2 \times 20 + 10 = 50\%$ 。

The LED flashing frequency indicates setting position.  
Single flash: Flip rate adjustment  
Double flash: Elevator end point setting  
Flash in group of 3: Aileron end point setting  
Flash in group of 4: Swashplate dampening setting  
Flash in group of 5: Swashplate accelerate setting

此燈閃爍次數為進入的程式介面位置：  
閃爍次數1:滾轉速率調整  
閃爍次數2:升降舵行程極限設定  
閃爍次數3:副翼行程極限設定  
閃爍次數4:十字盤柔化設定  
閃爍次數5:十字盤加速設定

Fully lit LED1 indicates 20%  
Fully lit LED2 indicates 20%  
Flashing LED3 indicates 10%  
So the setting value is  $2 \times 20 + 10 = 50\%$

LED1恆亮代表20%  
LED2恆亮代表20%  
LED3閃爍代表10%  
故設定值為 $2 \times 20 + 10 = 50\%$ 。

Move rudder stick  
撥動尾舵搖桿

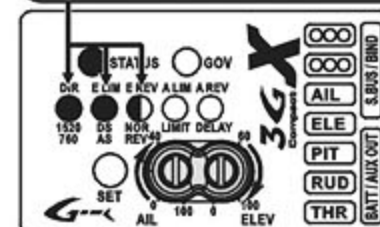
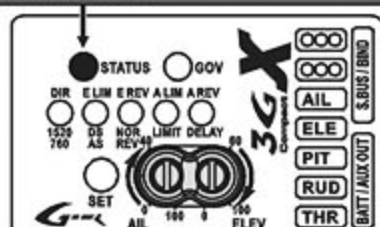
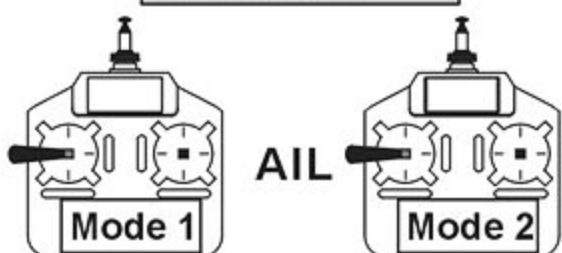



## 1. AILERON ROLL RATE 滾轉速率調整

### Setting Instruction:

1. After entering setting mode, STATUS LED flashes once.
2. Aileron and elevator rate can be adjusted independently.
3. Moving the aileron stick will display aileron roll rate on the LED. The more LEDs, the faster the roll rate. Moving the aileron stick can increase or decrease the number of LEDs that lights up between LED1 to LED5, which sets the aileron roll rate. Same method is used to adjust the elevator flip rate when elevator stick is moved.
4. Elevator flip rate is adjusted based on aileron roll rate. When the difference between elevator flip rate and aileron roll rate differs by 20% or more, 3GX will automatically adjust until the error rate falls within range. Therefore, we recommend adjustment aileron roll rate first, and then adjust elevator flip rate.
5. Moving the related control stick, LED will automatically jump to the set rate display of the specific stick function. For example, moving the aileron stick, LED1 to LED5 will display aileron set rate. Moving elevator stick, LED to LED5 will display elevator set rate.

### 設定說明：

1. 進入設定後STATUS的燈號閃爍一次。
2. 副翼及升降滾轉速率可以分開調整。
3. 撥動副翼搖桿會顯示副翼滾轉速率之LED燈號，燈號越多表示滾轉越快，再次撥動副翼搖桿可以增加或減少LED1~LED5亮燈數量，進而調整副翼滾轉速率，同理撥動升降舵搖桿會顯示升降滾轉速率之LED燈號，可以調整前後滾轉速率。
4. 升降滾轉速率會依副翼滾轉速度而調整，當升降滾轉速度和副翼滾轉速度相差20%以上，3GX會自動調整與限制在誤差範圍內，所以建議先調整副翼滾轉速率，再調整升降滾轉速率。
5. 動相關搖桿LED會自動跳至該搖桿設定值，例如動副翼搖桿，LED1~5會顯示副翼設定值。動升降搖桿，LED1~5會顯示升降設定值。

Move aileron stick to adjust aileron roll rate  
撥動副翼搖桿調整副翼滾轉速率

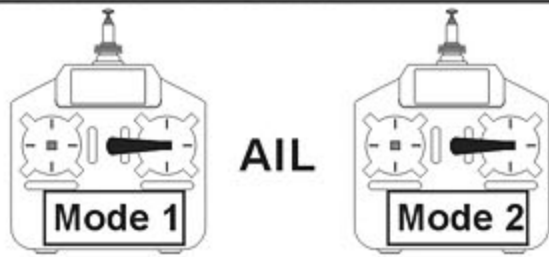

STATUS Single flash  
STATUS閃爍一次

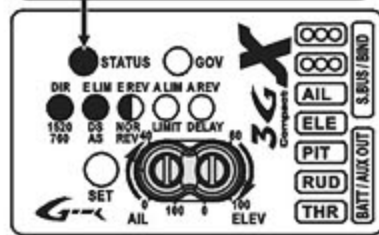

Move elevator stick to adjust elevator flip rate  
撥動升降搖桿調整升降滾轉速率

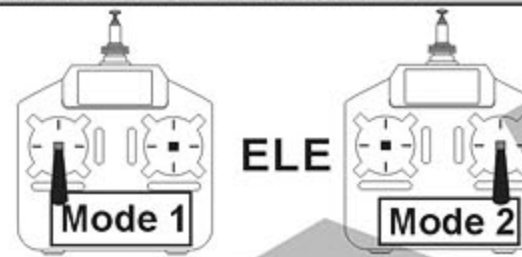

STATUS Single flash  
STATUS閃爍一次

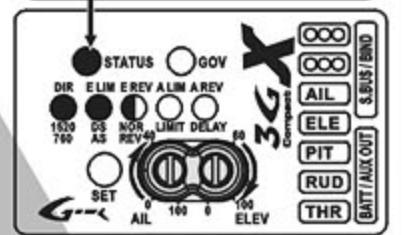

## 2. ELEVATOR END POINT SETTING 升降舵行程極限設定

### Setting Instruction:

1. Before entering elevator and aileron limit setting, please switch the transmitter to throttle hold mode and push the throttle down to 0° position to avoid mechanical interference due to excess travel range.
2. After entering setting mode, STATUS LED flashes twice
3. After entering setting mode, elevator may deviate as much as 8 degrees plus compensating rate either forward or back. Moving elevator stick can adjust servo travel limit. For example, if LED shows 50%, total elevator travel range is  $8 + 0.5 * 8 = 12$  degrees.
4. Generally 70% is suitable for most helicopter frame. If recommended value is not used, please adjust setting until maximum is reached without mechanical binding.

### 設定說明：

1. 進入升降舵與副翼行程極限設定前，請先將遙控器切換在熄火模式，並將油門搖桿設在0度的位置，避免行程過大時造成結構干涉
2. 進入設定後STATUS的燈號閃爍兩次。
3. 進入後升降舵會偏至8度+外環值，有可能偏前或偏後，搖動升降舵搖桿可以調整伺服機行程極限。例如LED顯示設定為50%，升降舵行程總行程約為 $8 + 0.5 * 8 = 12$ 度。
4. 一般而言70%可以適用於大部分的直升機機體，如果不使用建議值，請設定至機械結構不至干涉之極限值。

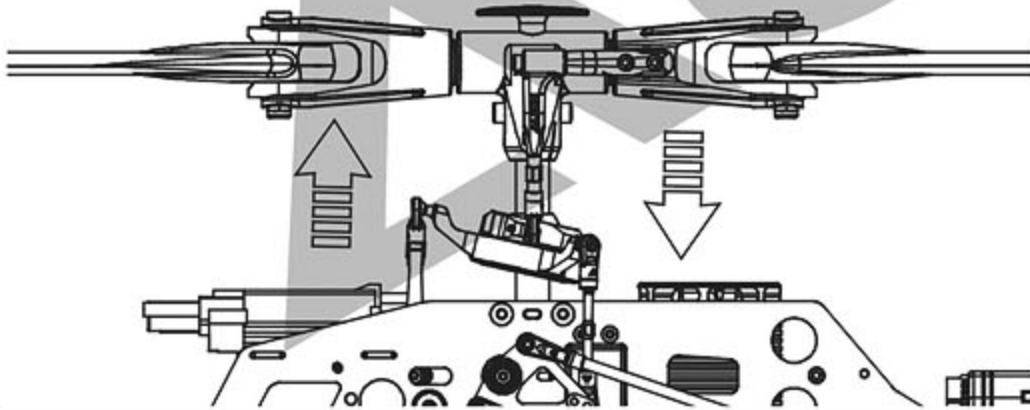

Move elevator stick to adjust elevator travel limit  
撥動升降搖桿調整升降舵行程極限值

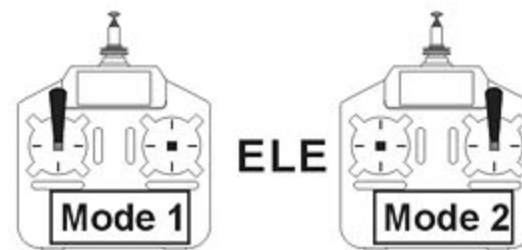

STATUS Double flash  
STATUS閃爍兩次

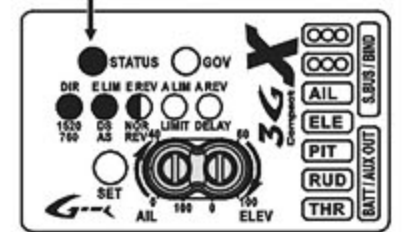

## 3. AILERON END POINT SETTING 副翼行程極限設定

### Setting Instruction:

1. After entering setting mode, STATUS LED flashes 3 times.
2. After entering setting mode, aileron may deviate as much as 8 degrees plus compensating rate either forward or back. Moving aileron stick can adjust servo travel limit. For example, if LED shows 50%, total elevator travel range is  $8 + 0.5 * 8 = 12$  degrees.
3. Generally 70% is suitable for most helicopter frame. If recommended value is not used, please adjust setting until maximum is reached without mechanical binding.

### 設定說明：

1. 進入設定後STATUS的燈號閃爍三次。
2. 進入後副翼會偏至8度+外環值，有可能偏左或偏右，撥動副翼搖桿可以調整伺服機行程極限。例如LED顯示設定為50%，總舵量約為 $8 + 0.5 * 8 = 12$ 度。
3. 一般而言70%可以適用於大部分的直昇機機體，如果不使用建議值，請設定至機械結構不至干涉之極限值。

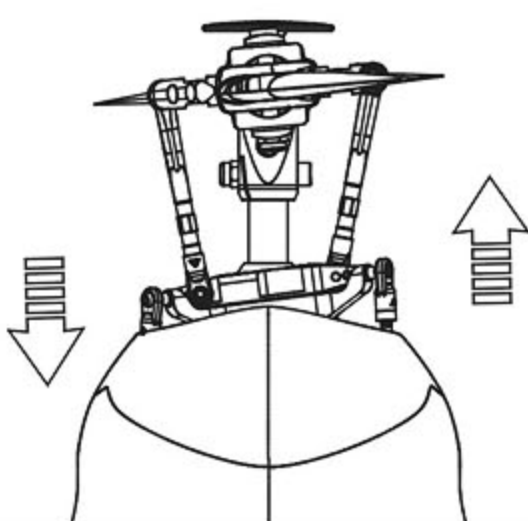

Throttle stick must be maintained  
撥動副翼搖桿調整副翼行程極限值

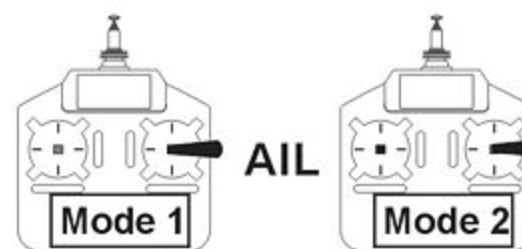

STATUS Flash in group of 3  
STATUS閃爍三次

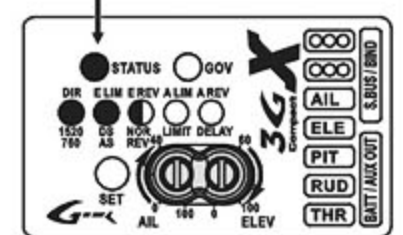



#### 4. SWASHPLATE DAMPENING SETTING 十字盤柔化設定

##### Setting Instruction :

1. After entering setting mode, STATUS LED flashes 4 times.
2. Move the aileron stick to adjust cyclic pitch dampening rate; the more LED lights up, the more dampening effect. Please note aileron and elevator dampening cannot be adjusted separately. Moving aileron stick is for adjusting cyclic pitch dampening rate, but moving elevator stick is for adjusting collective pitch dampening rate, NOT elevator dampening rate.
3. The more dampening effect, the smoother helicopter flies, but feels less direct. The rate of dampening should be adjusted to suit pilot's preferences.

##### 設定說明

1. 進入設定後STATUS的燈號閃爍四次。
2. 撥動副翼搖桿可以調整循環螺距柔化程度，LED亮燈越多，柔化越多，但請注意副翼及升降柔化不可分開調整，所以撥動副翼搖桿為調整循環螺距柔化，但撥動升降舵搖桿是調整集體螺距柔化程度，而非升降舵柔化程度。
3. 柔化程度越多，機體飛行越平順，但越不直接，柔化程度可以個人不同手感調整。

Move aileron stick to adjust cyclic pitch dampening  
撥動副翼搖桿調整循環螺距柔化值

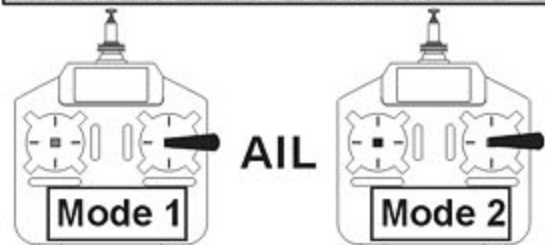

STATUS Flash in group of 4  
STATUS閃爍四次

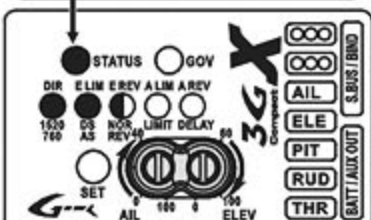

Move elevator stick to adjust collective pitch dampening  
撥動升降搖桿調整集體螺距柔化值

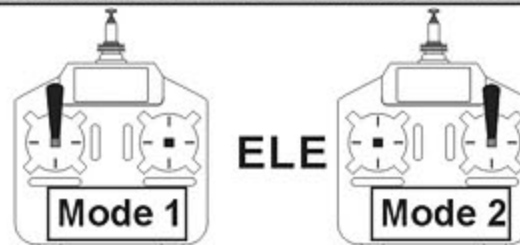

STATUS Flash in group of 4  
STATUS閃爍四次

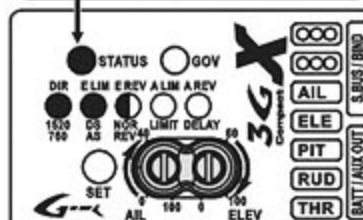

#### 5. SWASHPLATE ACCELERATE SETTING 十字盤加速設定

##### Setting Instruction:

1. After entering setting mode, STATUS LED flashes 5 times.
2. Move the aileron stick to adjust cyclic pitch acceleration rate; the more LED lights up, the more acceleration effect. Please note aileron and elevator acceleration cannot be adjusted separately. Moving aileron stick is for adjusting cyclic pitch acceleration rate, but moving elevator stick is for adjusting collective pitch acceleration rate, NOT elevator acceleration rate.
3. When cyclic pitch acceleration is active, hovering point fixation ability may be reduced. Beginners or F3C pilots should minimize cyclic pitch acceleration rate value, or set it to zero.

##### 設定說明：

1. 進入設定後STATUS的燈號閃爍五次。
2. 撥動副翼搖桿可以調整循環螺距加速程度，亮燈越多，加速越多，但請注意副翼及升降加速是不可分開調整，所以撥動副翼搖桿為調整循環螺距加速，但撥動升降舵搖桿是調整集體螺距加速程度，而非升降舵加速程度。
3. 開啟循環螺距加速，會造成停旋時定點性較差，初學者或F3C飛行者請將循環螺距加速設定值降低，或設定為0。



Setting swashplate acceleration may increase the burst amp draw of servos. Therefore, BEC output capability should be confirmed to handle burst current when setting collective pitch acceleration, otherwise insufficient current supply may result in flight accidents. We recommend direct power supply if acceleration is higher than 50%.

設定十字盤加速會造成伺服機瞬間耗電量較高，所以請注意如果設定集體螺距加速，必須留意BEC是否可提供足夠的瞬間電流，否則有可能造成伺服器瞬間供電不足，而造成飛行事故，所以直接供電才建議可調整至50%以上的設定值。

Move aileron stick to adjust cyclic pitch acceleration  
撥動副翼搖桿調整螺距循環加速值

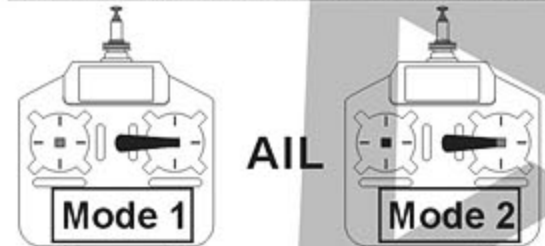

STATUS Flash in group of 5  
STATUS閃爍五次

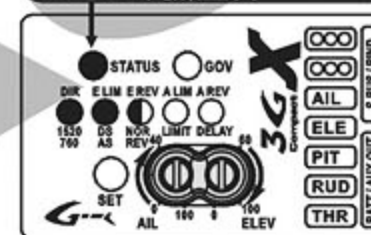

Move elevator stick to adjust collective pitch acceleration  
撥動升降搖桿調整集體螺距加速值

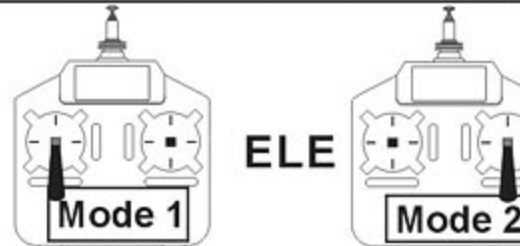

STATUS Flash in group of 5  
STATUS閃爍五次

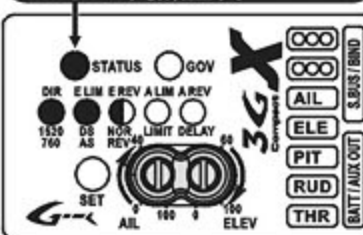

#### RUDDER GYRO SETUP 尾舵陀螺儀設定

After the system reboots, part of flybarless setup is completed. Now the rudder gyro needs to setup. Push and hold the SET button for 2 seconds to enter the rudder gyro setup mode.

If your transmitter has the following settings, please disable it or set the value to zero.

完成開機後Flybarless部分已設定完成，接著要設定尾舵陀螺儀，於待機狀態下持按"SET"鍵2秒進入尾舵陀螺儀設定。如果您的遙控器有下列功能時，請設定為關閉(OFF)或數值設定為零。

- ATS
- Pilot authority mixing
- Throttle to rudder mixing
- Rudder to gyro mixing
- Pitch to rudder mixing
- Revolution mixing



3GX Flybarless rudder gyro has the factory setting of 1520  $\mu$ s and DS digital servo. Double check your servo spec and change the gyro setting as needed to avoid damages to the servo.

3GX Flybarless 尾舵陀螺儀出廠設定值為：1520  $\mu$ s寬頻與DS數位伺服器模式，安裝時請確認您的伺服器規格，避免設定值不同而造成伺服器損壞。

#### 1. 1520 $\mu$ S (STANDARD) OR 760 $\mu$ S (NARROW BAND) SERVO FRAME RATE SETUP. 1520 $\mu$ s(標準)或760 $\mu$ s(窄頻)伺服器設定

3GX Flybarless system is compatible with both the 760  $\mu$ s narrow frame rate servos (such as Futaba S9256, S9251, BLS251), as well as the standard 1520  $\mu$ s frame rate servos (most others). Proper frame rate must be selected based on your servo's specifications.

To enter the setup mode : Press and hold the SET button for 2 seconds until STATUS LED flashes. The 1520/760 LED will light up indicating servo frame rate setup mode. Push the transmitter rudder stick left or right to select the frame rate. For example, if rudder is pushed to the left (or right) and STATUS LED turns green, the frame rate is set to 1520  $\mu$ s. To set it to 760  $\mu$ s, the rudder stick need to be pushed from the center to the opposing end 3 times for the STATUS LED to turn red, indicating frame rate set to 760  $\mu$ s.

3GX Flybarless panel : Each setting value is labeled on the 3GX flybarless control unit with either green or red lettering, which corresponds to the STATUS LED color. Subsequent setup mode is entered by a single press of the SET button. Setup mode will exit if no activity is detected in 10 seconds.



3GX Flybarless相容兩種波寬控制系統，若您使用的伺服器屬於760  $\mu$ s系統（如Futaba S9256、S9251、BLS251），則必須將3GX Flybarless設定於760的模式，其他未標示760  $\mu$ s規格的伺服器，一般皆為1520  $\mu$ s系統，須設定為1520的模式。

進入功能設定模式：持按面板上的"SET"設定鍵約2秒，此時"STATUS"狀態指示燈會開始閃爍，且"1520/760"的功能設定指示燈會亮起，表示進入標準／窄頻伺服器選項，利用遙控器方向舵搖桿的左右方向來選擇設定值，例如方向舵搖桿往左（或右）時，"STATUS"指示燈為綠色，表示設定值為1520  $\mu$ s系統；若要設定為窄頻760  $\mu$ s系統時，必須將搖桿由中立點往相反方向連續撥動3次，使"STATUS"指示燈亮紅色，才會進入760  $\mu$ s系統。

3GX Flybarless的面板：標籤上已使用綠／紅色的字體提示"STATUS"燈色所代表的設定值。設定完成後按"SET"鍵一次可進入下一個設定，或是10秒內不做任何設定，系統會自動離開設定模式。

Green LED : 1520  $\mu$ s standard band  
Red LED : 760  $\mu$ s narrow band  
綠燈 : 1520  $\mu$ s寬頻伺服器  
紅燈 : 760  $\mu$ s窄頻伺服器

Standard/Narrow band mode  
寬頻/窄頻模式

Select by moving the rudder stick left and right  
左右撥動方向舵選擇

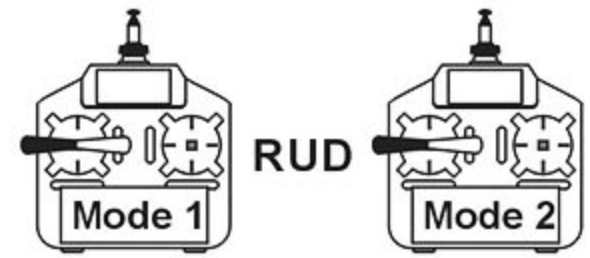

## 2.DS (DIGITAL) / AS (ANALOG) SERVO SELECTION DS數位/AS類比伺服器選擇

There is a direct correlation between servos' speed to gyro's performance. Faster servos are able to execute commands from the gyro at faster and higher precision. Due to the high performance gyro sensors used in the 3GX flybarless system, premium high speed digital rudder servos are mandatory for optimal tail performance. Some of the recommended rudder servos.

Setup method : Press and hold the SET button for 2 seconds to enter the setup mode, then press the SET button to select DS/AS setup mode, as indicated by the lighting of DS/AS LED. Using the transmitter's rudder stick, select either digital servo DS mode (STATUS LED is green), or analog servo AS mode (STATUS LED is red).

伺服器動作速度攸關陀螺儀的性能，伺服器動作愈快，就能立即反應陀螺儀送出的指令，發揮快速精準的效能；由於3GX Flybarless具有相當快速的反應時間與靈敏度，所以建議您搭配高速型數位伺服器，以獲得最佳效能。

設定方式：持按"SET"鍵2秒進入功能設定模式，再按"SET"鍵選擇DS/AS選項，(DS/AS指示燈亮起)，利用方向舵搖桿選擇數位DS (STATUS為綠燈)或類比AS (STATUS為紅燈)伺服器。

Green LED : DS digital servo  
Red LED : AS analog servo  
綠燈 : DS數位伺服器  
紅燈 : AS類比伺服器

Digital / analog mode  
數位/類比模式

**CAUTION 注意**  
Using an analog servo in DS mode will cause damages to the servo.  
在DS模式下連接"AS類比伺服器"將導致伺服器燒毀。

Select by moving the rudder stick left and right  
左右撥動方向舵選擇

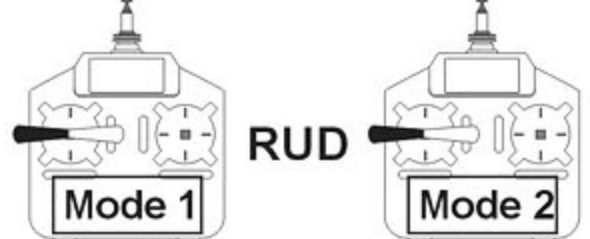

## 3. RUDDER SERVO DIRECTION CHECK AND LINK ADJUSTMENT 檢查尾舵伺服器正逆轉方向與調整連桿

Move the transmitter rudder stick left/right, and check for the correct direction of the rudder servo. If needed, servo reverse is done from the transmitter's REV (reverse) function.

For tail pitch adjustment, center the rudder servo by either setting the 3GX flybarless to normal rate mode (non-heading lock), or press and hold the SET button for 2 seconds. With the rudder servo centered and servo horn at 90 degrees, adjust the linkage length until tail pitch slider is centered on the tail output shaft as shown in diagram.

左右撥動尾舵搖桿，確認尾舵伺服器移動的方向是否正確，若不正確請更改遙控器上的尾舵伺服器正逆轉方向。

將3GX Flybarless切換成非鎖定模式或持按"SET"鍵2秒，使尾舵伺服器保持在中立點的位置上，調整伺服舵片，盡可能使尾舵連桿與伺服擺臂呈90度，接著調整連桿長度使尾Pitch控制組置中。

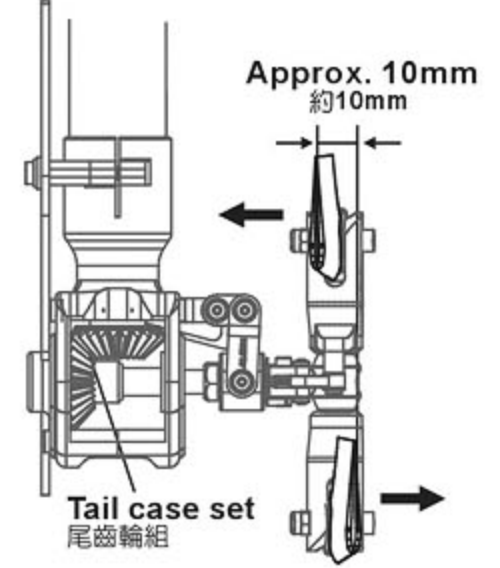
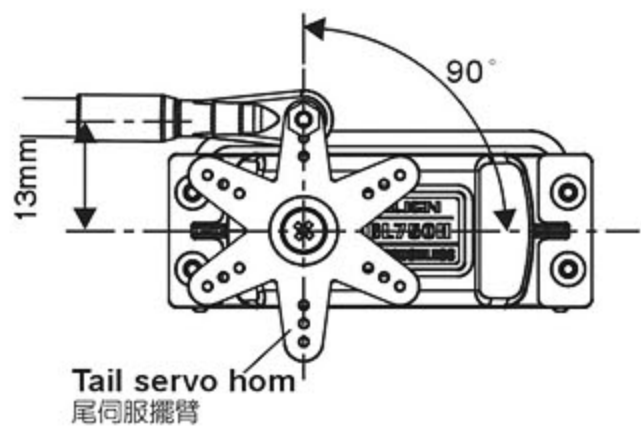

## 4. GYRO NOR/REV SETTING NOR/REV陀螺儀正反向開關設定

Lift up the helicopter by hand, and turn it to the left (yaw). Check if the rudder servo is applying correct compensation to the right. If reversed, set the NOR/REV setting as follow.

Setup method : Press and hold the SET button for 2 seconds to enter the setup mode, then press the SET button to select NOR/REV setup mode, as indicated by the lighting of NOR/REV LED. Using the transmitter's rudder stick, select either NOR (STATUS LED is green), or REV (STATUS LED is red).

提起直昇機，將機頭往左擺動，若尾舵伺服器的擺動方向與遙控器的方向舵搖桿打右舵同方向時，表示陀螺儀的動作方向設定正確，若不正確時請更改正反向設定。  
設定方式：持按"SET"鍵2秒進入功能設定模式，選擇NOR/REV選項，以方向舵選擇NOR (STATUS為綠燈)或REV (STATUS為紅燈)。



Green LED : normal direction  
Red LED : reverse direction

綠燈 : NOR正向  
紅燈 : REV反向

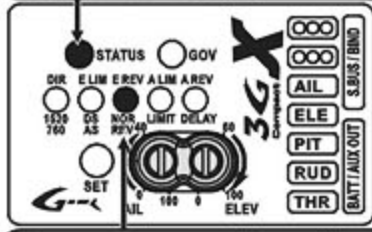

Gyroscope direction settings  
陀螺儀正反向設定

Select by moving the rudder stick left and right  
左右撥動方向舵選擇

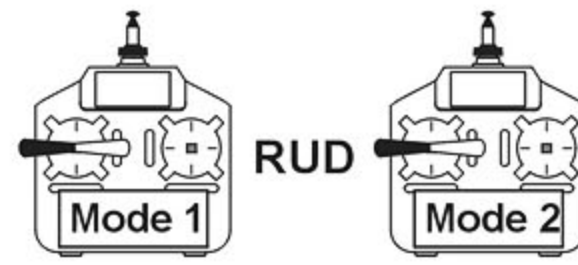

### 5. LIMIT RUDDER SERVO ENDPOINT SETTING LIMIT尾舵伺服器行程量調整

Press and hold the SET button for 2 seconds to enter the setup mode, then press the SET button repeatedly to select LIMIT setup mode, as indicated by the lighting of LIMIT LED. Push the transmitter rudder stick left until tail pitch slider reaches the end, then center the rudder stick and wait 2 seconds for the STATUS LED to flash red. Then push the rudder stick right until tail pitch slider reaches the end, then center the rudder stick and wait 2 seconds for the STATUS LED to flash red. This completes the left and right endpoint limit adjustment of servo travel. Insufficient servo travel will degrade helicopter performance, while excessive travel will cause binding and damage rudder servo.

持按"SET"鍵2秒進入功能設定模式，此時尾伺服器會保持在中立點的位置上，選擇LIMIT選項，接著將方向舵搖桿慢慢的往左移動，使尾控制組達到該側的大行程限度後，將搖桿回歸中立點不動，待2秒後"STATUS"指示燈會亮紅燈閃爍，表示左側行程量已記憶；接著將尾舵搖桿向右移動至控制組最大行程限度後，再將搖桿回歸中立點不動，待2秒後"STATUS"指示燈亮紅燈閃爍，即完成左右行程量設定，行程量不足時會影響陀螺儀與直昇機的性能，行程量過大易造成伺服器損壞。

**Mode 1**  
**Mode 2**

Tail gears  
尾齒輪組

Push the transmitter rudder stick left until tail pitch slider reaches the end, then center the rudder stick and wait 2 seconds for the STATUS LED to flash red. This completes the rudder endpoint limit adjustment for the left side.

將方向舵慢慢往左撥動，使控制組達到左舵最大行程限度後，將搖桿回歸中立點不動，待2秒後"STATUS"紅燈閃爍表示左舵行程記憶量完成。

**Mode 1**  
**Mode 2**

Tail gears  
尾齒輪組

Push the rudder stick right until tail pitch slider reaches the end, then center the rudder stick and wait 2 seconds for the STATUS LED to flash red. This completes the rudder endpoint limit adjustment for the right side.

將方向舵慢慢往右撥動，使控制組達到右舵最大行程限度後，將搖桿回歸中立點不動，待2秒後"STATUS"指示燈表示右舵行程記憶量完成。

Flashing red LED indicates settings have been registered  
紅燈閃爍時表示記憶完成

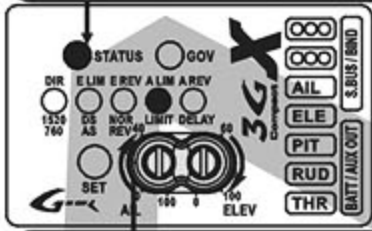

Endpoint limit settings  
行程量設定



**CAUTION 注意**  
Rudder travel limit setting lower than 50% will not be registered. Mechanical fix (moving link ball closer to center of servo horn) is needed for excessive servo travel when LIMIT function is below 50%.

尾舵行程量設定不可低於50%，否則3GX Flybarless將不予記憶，若發生行程量設定後，尾控制組仍會超過最大行程，請將尾伺服器臂的球頭向內移動，避免行程不足影響陀螺儀性能。

### 6. HELICOPTER SIZE AND DELAY SETTINGS 直昇機模式與DELAY控制延遲量調整

This setting includes two functions :

- (1) For small helicopters such as T-REX 250/450, set this setting to small helicopter (STATUS LED red). For larger helicopters such as T-REX 500/550/600/700/800 set this setting to large helicopter (STATUS LED green).

此設定結合兩項功能：

- (1) 3GX Flybarless支援小型/迷您型室內電直，請依您直昇機的類型選擇適合的模式，如：T-REX250/450請選擇小型/迷您型模式（設定時"STATUS"指示燈為紅色）；T-REX500/550/600/700/800請選中大型直昇機模式（設定時"STATUS"指示燈為綠色）。

Green LED: suitable for larger helicopters such as T-REX500/550/600/700/800  
Red LED: suitable for smaller helicopter such as T-REX 250/450

綠燈：適用T-REX500/550/600/700/800大型直昇機  
紅燈：適用T-REX250/450小型直昇機

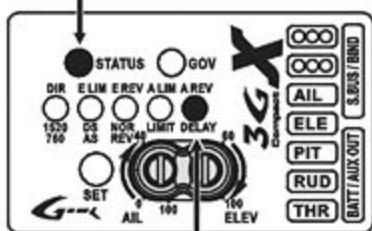

Helicopter size selection and servo delay settings  
大小直昇機模式與延遲量設定

Select by moving the rudder stick left and right  
左右撥動方向舵選擇

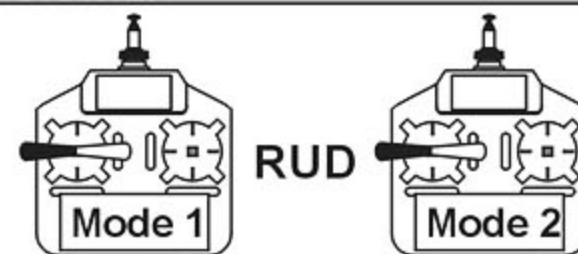

- (2) The DELAY function is utilized when slower rudder servo causes tail hunting (wagging). This can be observed after a hovering pirouette comes to a stop. If tail hunting occurs, gradually increase DELAY value to eliminate it. For best performance, DELAY value should be kept as low as possible without tail hunting.

Setup method : Press and hold the SET button for 2 seconds to enter the setup mode, then press the SET button to select DELAY setup mode, as indicated by the lighting of DELAY LED. The choice of small or large helicopter is done by moving the transmitter rudder stick left or right while observing the color of the STATUS LED. For small helicopters STATUS LED will be red, and large helicopter will be green. The amount of servo delay is set by how far you push the rudder stick, followed by pushing the SET button.



(2) 使用速度較慢的尾舵伺服器較容易產生追蹤現象，當直昇機停懸時，打方向舵使直昇機快速自轉，當方向舵回到中立點使直昇機停止自轉時，此時若發生追蹤現象，請增加控制延遲的設定量，一般而言在不產生追蹤現象的原則下控制延遲的設定量越小越好，否則尾舵的動作會變得遲緩。

設定方式：持按"SET"鍵2秒進入功能設定模式，選擇至DELAY選項，以方向舵搖桿選擇小型/迷你型電直，如：T-REX 250/450 (STATUS為紅燈)，或中大型直昇機如T-REX500/550/600/700/800 (STATUS為綠燈)，若要同時設定DELAY控制量時，則利用方向舵搖桿的位置來設定，搖桿由中立點推至"DELAY"燈開始閃爍時為0%，推至最大行程時控制量為100%，將搖桿推至所需的延遲量時保持不動，並按下"SET"鍵確認，即可同時設定直昇機模式與延遲量。

**Green LED for T-REX800**  
T-REX800設定為綠燈

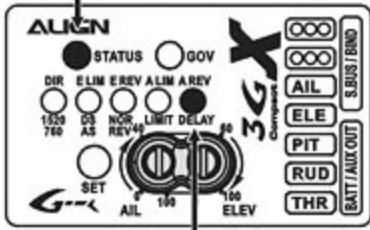

0% when DELAY LED begins flashing  
DELAY燈開始閃爍時為0%

**Green LED for T-REX800**  
T-REX800設定為綠燈

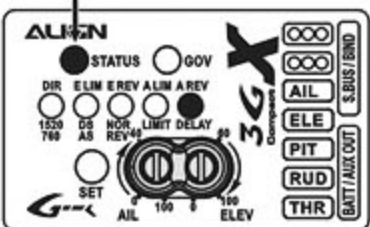

Gradually move the transmitter rudder stick until DELAY LED begins to flash, the delay value is 0% at this point.  
輕推方向舵搖桿至"DELAY"燈開始閃爍時，延遲量為0%

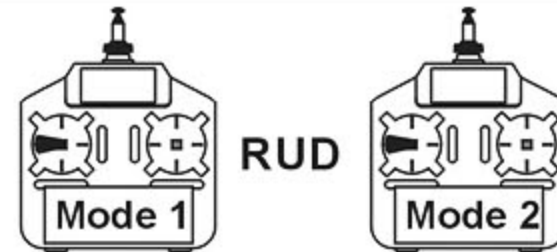

Continue to move the rudder stick until desired delay value is needed, then press the SET button to register the setting. Maximum is 100% delay, with rudder stick pushed to the end.

方向舵推至最大行程時，延遲量為100%，將搖桿推至所需的延量，按下"SET"鍵確認

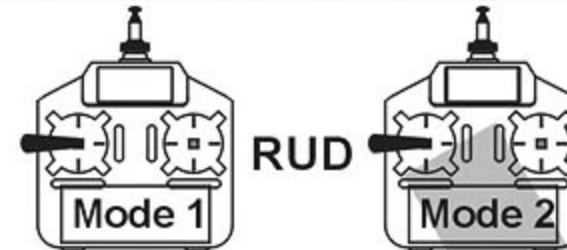

## 7. ANTI TORQUE COMPENSATION DIRECTION SETTING 反扭力補償正反向設定

To achieve consistent gyro gain on left and right, 3GX has built in anti-torque compensation function. User need to confirm if 3GX is mounted right side up or upside down.

Right side up: Installed with 3GX label facing up, anti-torque compensation set to positive (green STATUS LED).

Upside down: Installed with 3GX label facing down, anti-torque compensation set to negative (red STATUS LED).

為使陀螺儀左右感度一致，3GX內置反扭力補償功能，使用者需確認3GX為正裝或反裝。

正裝：安裝時3GX面板朝上，反扭力補償設為正向 (STATUS綠燈)。

反裝：安裝時3GX面板朝下，反扭力補償設為反向 (STATUS紅燈)。

Setup method: Press and hold the SET button for 2 seconds to enter setup mode, select until anti-torque compensation section, as indicated by lighting of all 5 setup mode LEDs. Using the rudder stick to select either positive anti-torque compensation (green STATUS LED) for right side up mounting, or negative anti-torque compensation (red STATUS LED) for upside down installation.

設定方式：持按"SET"鍵2秒進入功能設定模式，選擇至反扭力補償設定項，此時5顆功能設定指示燈全亮，接著以方向舵搖桿選擇，當3GX正裝時，須設定為正向 (STATUS綠燈)；當3GX反裝時，須設定為反向 (STATUS紅燈)。

Green : Right side up mounting  
Red : Upside down mounting

綠燈：3GX正裝，反扭力補償正向  
紅燈：3GX反裝，反扭力補償反向

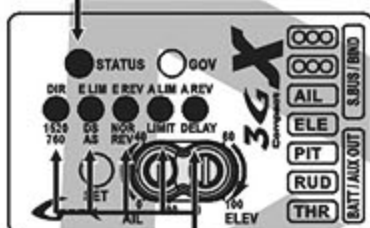

Anti Torque Compensation direction setting  
反扭力補償正反向設定

Select by moving the rudder stick left and right  
左右撥動方向舵選擇

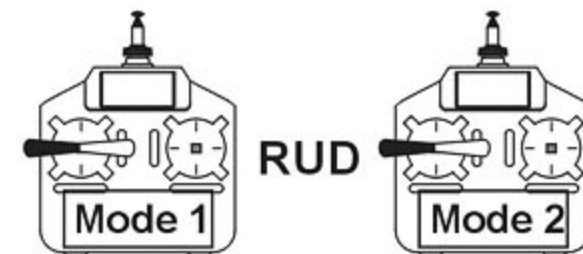

## 8. SENSITIVITY ADJUSTMENT 感度調整

For radio with built in gyro gain settings, gain can be adjusted directly. For example, 50%-100% setting on the radio translates to 0% - 100% gain in the heading lock mode; 50%-0% setting on the radio translates to 0%-100% gain in the normal (non-heading) lock mode.

Actual gain value differs amongst servos and helicopters. The goal is to find the maximum gain without tail hunting. This can only be done through actual flight tests.

The recommended starting point for transmitter's gyro gain setting should be 70~80% for hovering, 60~70% for idle-up. Value should be tuned under actual flight conditions by increasing to the maximum gain without tail hunting.

一般具有陀螺儀感度設定功能的遙控器，可直接進入GYRO功能選項進行感度值的設定，設定值50%則陀螺儀的感度為0，設定值50%~100%，則陀螺儀感度值為鎖定狀態的0~100%；設定值50%~0%，則陀螺儀感度值為非鎖定狀態的0~100%。

感度值的大小會隨著伺服器與直昇機的不同而有所差異，一般而言，在不產生追蹤現象（直昇機尾部出現左右搖擺的情況）的前提下感度值愈高愈好，所以只能透過實際飛行的狀況來進行調整。

進入遙控器感度設定的選項，剛開始停懸時建議先設定在70~80%左右，Idle up飛行時設定在60~70%左右，之後再依實際飛行的狀態再行修正，如果沒有追蹤現象發生時可再調整高感度，若發生追蹤現象時，則調低感度。



For radios (IE Futaba) using 0-100% as heading lock gain scales, the recommended gain setting is 30% to 35%.  
For radio that uses the 50 -100% scale (such as JR and Hitec), the recommended gain setting is 70% to 75%.

鎖定感度值為0~100%的遙控器，如Futaba，建議設定在30~35%左右；鎖定感度值為50~100%的遙控器，如JR、HITEC，建議感度值設定在70~75%左右。

## Specifications 產品規格

1. Operating voltage range :  
DC 3.5V~8.4V

2. Operating current consumption :  
<80mA @ 4.8V

3. Rotational detection rate : ±300°/sec

4. Rudder yaw detection rate : ±600°/sec

5. Sensor resolution : 12bit

6. Operating temperature : -20°C~65°C

7. Operating humidity : 0%~95%

8. Dimension/Weight :

36.5x25.2x15.6mm/ 11g

●RoHS certification stamp

1. 適用電壓：DC 3.5V~8.4V

2. 消耗電流：<80mA @ 4.8V

3. 偵測側滾及前滾角速度：±300°/sec

4. 偵測尾舵角速度：±600°/sec

5. 感應器解析度：12bit(12位元)

6. 操作溫度：-20°C~65°C

7. 操作濕度：0%~95%.

8. 尺寸/重量：

36.5x25.2x15.6mm/11g

●符合RoHS限用規章



	Swashplate Settings 十字盤設定	3GX throttle calibration 3GX油門行程校正	Rudder Settings 尾舵設定	Flight Mode Setting 飛行特性設定
Enter Setup Mode 進入方式	Turn on transmitter, press/hold SET, power on heli, release SET before LEDs stop scrolling. 先開遙控器，按SET鍵，開機體電源，跑馬燈跑完之前放開按鍵。	Turn on TX, lower throttle all the way down, press/hold SET, power on heli, release SET after LEDs stop scrolling. 先開遙控器，將遙控器油門至於最低點，按SET鍵，開機體電源，跑馬燈跑完後放開按鍵。	With 3GX powered up, press SET for about one second. 在3GX運作狀態中，按SET鍵約一秒。	With 3GX powered up, push the rudder stick left or right, and hold the SET button for about one second. 在3GX運作狀態中將尾舵扳至左邊或右邊，接著按SET鍵約一秒。
Setting 1 設定一	LED 燈號 LED1 lit LED1 亮	LED1~5 all lit up LED1~5全亮	LED1 lit LED1 亮	STATUS flashes green 1 once STATUS閃綠燈一下
	Setting 程序 Mechanical Travel and Neutral point setting 機械行程與中立點設定	3GX throttle calibration 3GX油門行程校正	Wide/narrow servo band setting 寬/窄頻伺服設定	Cyclic pitch speed adjustment. 循環螺距速度調整
Setting 2 設定二	Setting 程序 Elevator Travel Limit Setting 升降舵行程設定		LED2 lit LED2 亮	STATUS flashes green 2 twice STATUS 閃綠燈兩下
	Setup Method 設定方式 Push elevator stick forward to limit, and release. 將遙控器升降舵搖桿往前推至最前位置，然後放開。	Push throttle open fully to complete setup, indicated by flashing of LED1~5, and then enter normal operation condition. 將油門位置推至全開，設定完成，LED1~LED5閃爍，後進入系統正常狀況。	Move rudder stick to select digital/analog servo. Green STATUS indicates digital servo, red indicates analog. 由尾舵搖桿設定數位/類比伺服機，STATUS綠燈為數位伺服機，紅燈為類比伺服機。	Elevator travel limit setting 升降舵行程極限設定
Setting 3 設定三	LED 燈號 LED3 Lit LED3 亮		LED3 lit LED3 亮	STATUS flashes green 3 twice STATUS 閃綠燈三下
	Setting 程序 Elevator gyro setting 升降舵陀螺正反設定		Rudder Gyro NOR/REV Setting 舵螺正反設定	Aileron travel limit setting 副翼行程極限設定
Setting 4 設定四	Setting 程序 Aileron Travel Limit Setting 副翼行程設定		LED4 lit LED4 亮	STATUS flashes green 4 once STATUS閃綠燈四下
	Setup Method 設定方式 Push aileron stick to extreme right, and release. 將副翼搖桿向右推至極限，然後將搖桿置中。	Tilt heli forward and back while observing gyro correction direction. If reversed, move elevator stick until STATUS LED changes color to reverse gyro direction. 前後搖動機身，觀看陀螺修正方向，如果錯誤，搖動升降搖桿，改變STATUS LED燈號以改變陀螺修正方向。	Move rudder stick to left/right until rudder at extreme end point, wait until STATUS change from green to red. 移動尾舵搖桿，移動尾舵左右行程至極限位置，稍做等待，STATUS燈由綠轉紅時完成該邊的設定。	Swashplate Dampening Setting 十字盤柔化設定
Setting 5 設定五	LED 燈號 LED 5 Lit LED 5 亮		LED 5 lit LED 5 亮	STATUS flashes green 5 once STATUS閃綠燈五下
	Setting 程序 Aileron gyro setting 副翼陀螺正反設定		Heli Size and Delay Value 直昇機模式與延遲量	Swashplate bump (acceleration) Setting 十字盤加速設定
Setting 6 設定六	Setting 程序 Gyro install reverse setting 陀螺安裝正反設定		LED 1~5 all lit up LED1~5全亮	
	Setup Method 設定方式 Use rudder stick to set gyro install position. Green STATUS is normal, red STATUS is install upside down. 以尾舵搖桿設定STATUS燈號，綠燈陀螺為正裝，反之紅燈為倒裝。			
Warnings 注意事項	After completing setting of 8 degrees SWASH, do not make further adjustments. If adjustment to helicopter's roll rate is needed, the adjustment must be made in the roll rate under flight mode's cyclic pitch section. 設定完8度後的SWASH值，不可以再調整，如果要調整直昇機滾轉速率，必須使用飛行特性設定功能的滾轉速率調整進行設定。			1. Flashing LED indicates 10%; fully lit LED indicates 20%. For example, LED1 and LED2 are fully lit, while LED3 is flashing, this is translated to 2*20+10=50%. LED閃爍為10%，全亮為20%，例如LED1~LED2全亮，LED3閃爍，設定值為2*20+10=50%。 2. Move the stick to display the stick function's setting value. For example, moving aileron stick will result in LED1~LED5 displaying aileron's setting value. 撥動相關搖桿LED會自動跳至該搖桿設定值，例如動副翼



**STEP1 步驟1**

Turn on Transmitter, and then receiver power.  
先開啓遙控器電源，再開啓接收器電源。

**STEP2 步驟2**

3GX Flybarless system will go through initialization process, as indicated by flashing of all LED's. Do not move the helicopter or transmitter sticks until initialization process completes.

此時3GX Flybarless控制器指示燈STATUS及DIR~A.REV會閃動，請勿移動直昇機與撥動搖桿，以利陀螺儀感應器進入初始化程序。

**STEP3 步驟3**

The completion of initialization process is indicated by the rapid up and down motion of swashplate 3 times while remaining level. Should the swashplate jumps up and down at a tilted position, the flybarless system initial setup need to be performed again. (Refer to page 6 Flybarless system initial setup)

The pitch of helicopter will remain locked until successful initialization. If the initialization process is unable to complete, with STATUS LED blinking red, Re-check all connections, and perform another reboot with helicopter remain stationary. Following successful initialization process, green STATUS LED indicates rudder is in heading lock mode, while red LED indicates normal non-heading mode. (Refer to page 14 Gain Adjustment)

如左圖示，初始化完成後，十字盤會保持水平上下小幅跳動三次，表示完成開機程序；如十字盤為傾斜跳動三次，則表示設定錯誤，須進入無平衡翼系統重新設定。（參考P.6 無平衡翼系統設定）

完成開機前直昇機螺距被固定無法動作，如果一直無法完成開機程序STATUS紅燈閃爍，請檢查開機時直昇機是否靜止或訊號線未接受，確認後重新開機。正常開機後，STATUS亮綠燈表示尾舵為鎖定模式，亮紅燈為非鎖定模式。（請參照P.14感度調整）

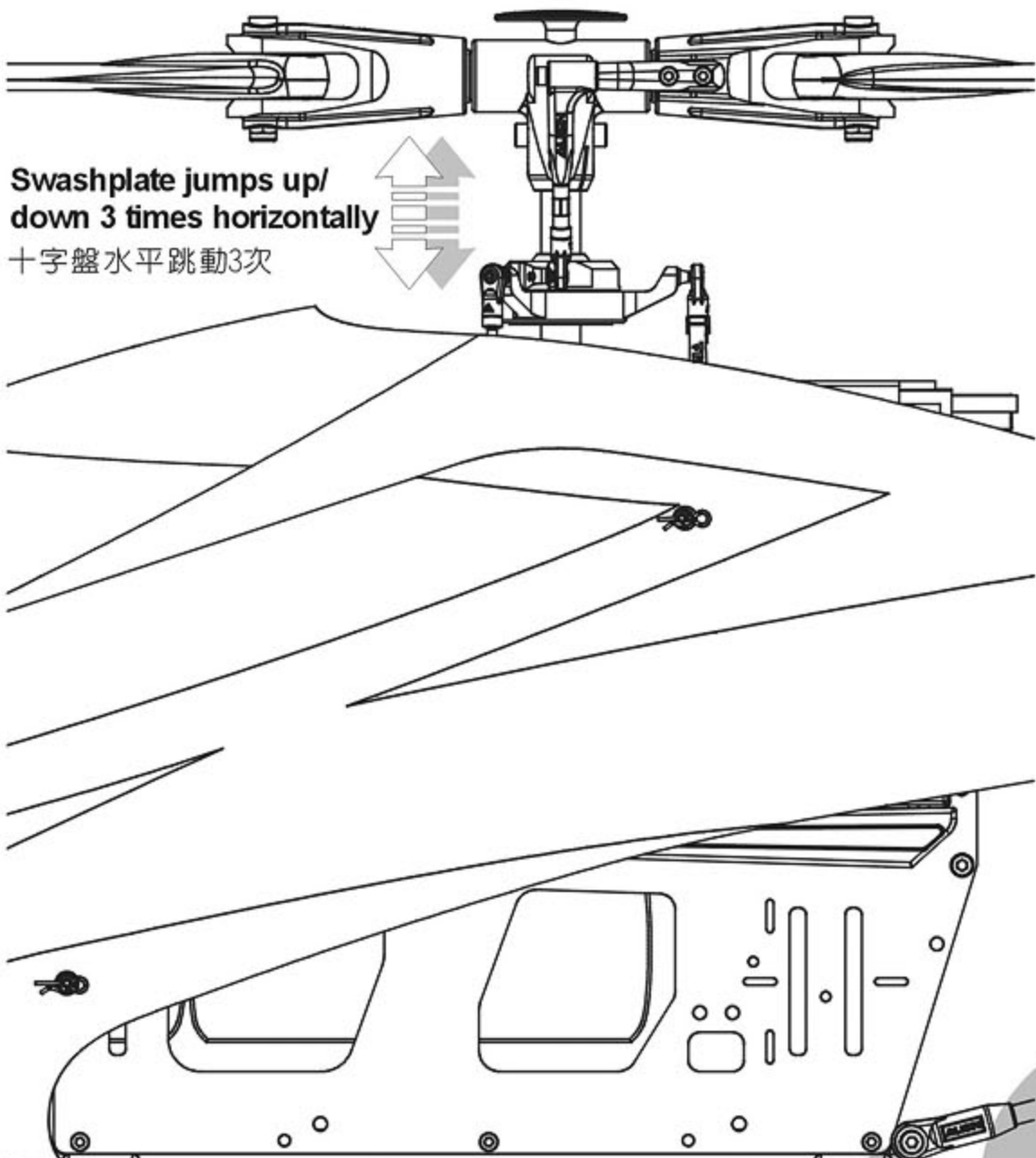

Swashplate jumps up/down 3 times horizontally  
十字盤水平跳動3次

**○ Swashplate jumps up and down 3 times horizontally represents successful initialization.**  
十字盤水平跳動三次代表正常開機

**✗ Swashplate jumps up and down 3 times tilted represents setup error.**  
十字盤傾斜跳動三次代表設定錯誤

Green = rudder in heading lock mode  
Red = rudder in normal mode  
綠燈為尾舵鎖定模式  
紅燈為尾舵非鎖定模式

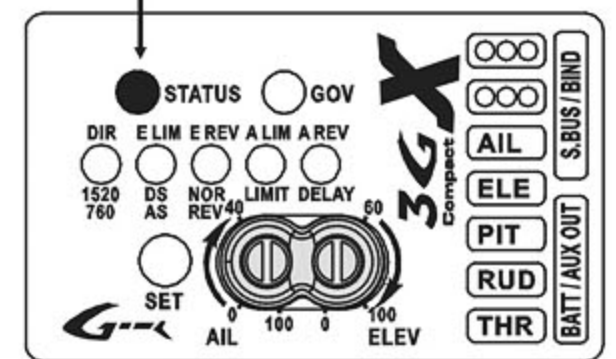

**STEP4 步驟4**

Tilt the helicopter forward and swashplate should tilt back to compensate. If reversed, perform the flybarless initial setup again and adjust the elevator reverse setting (Refer to page 8 E.REV setup)

將直昇機往前傾，陀螺儀應將十字盤向後修正，如果反向，重新進入Flybarless設定模式設定升降舵陀螺儀修正方向。（請參考第8頁 E.REV 升降舵陀螺儀正反向設定模式）

Swashplate correction direction  
十字盤修正方向

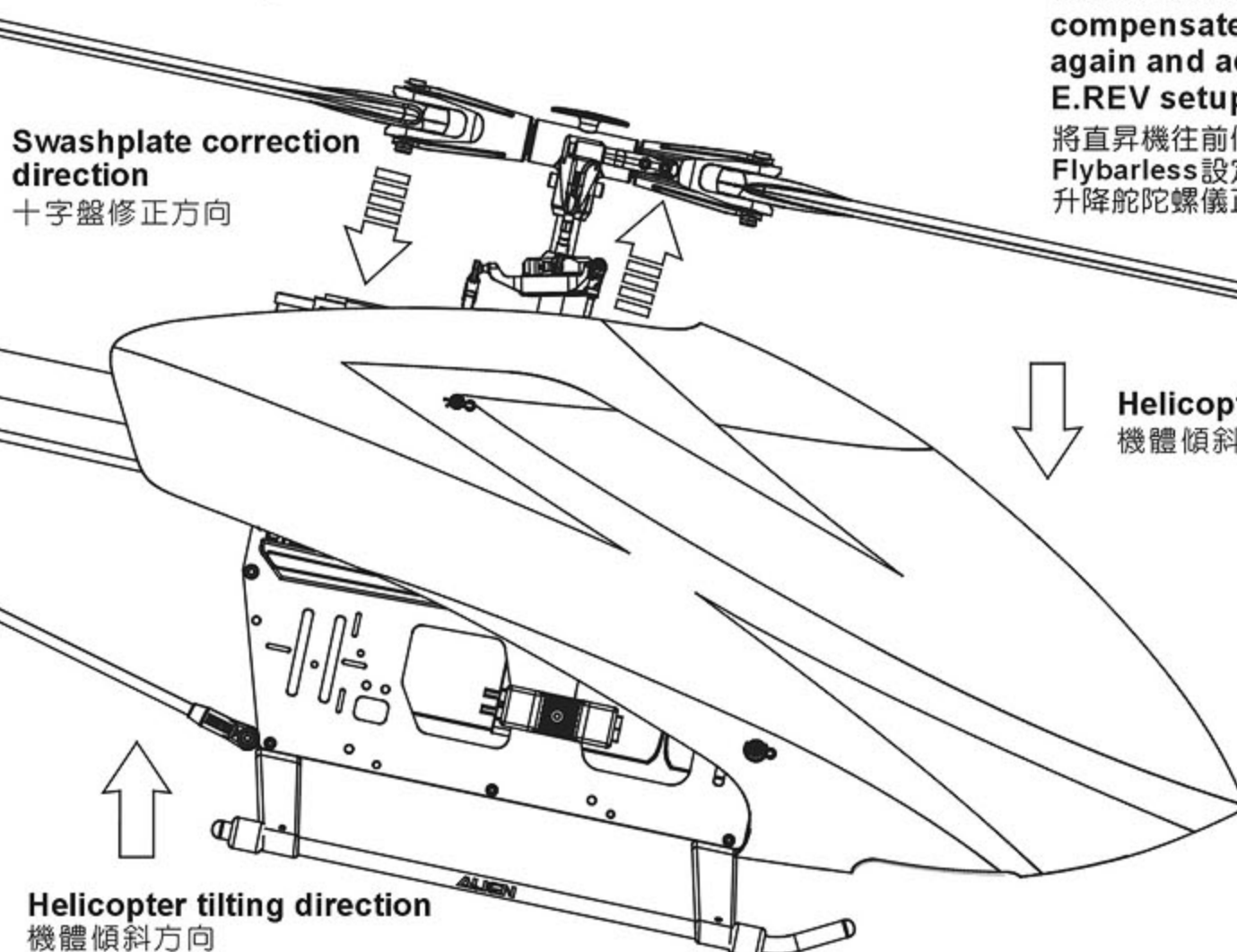

Helicopter tilting direction  
機體傾斜方向

Helicopter tilting direction  
機體傾斜方向



### STEP5 步驟5

Tilt the helicopter to the right and swashplate should tilt left to compensate. If reversed, perform the flybarless initial setup again and adjust the aileron reverse setting (Refer to page 9 A.REV setup)

將直昇機往右傾，陀螺儀應將十字盤向左修正，如果反向，重新進入 Flybarless 設定模式設定副翼陀螺儀修正方向。（如左圖所示：參考第9頁 A.REV 副翼陀螺儀正反向設定模式）

### STEP6 步驟6

With throttle stick all the way up (and down), and cyclic stick all the way left/right and up/down, check for any binding on the swashplate. If binding occurs, perform the flybarless initial setup again and adjust the endpoint limits.

將油門搖桿推到最高及最低，並將搖桿左右及前後推到底，十字盤動作是否流暢，如果不是必須重新進入 Flybarless 設定模式裏設定行程。

### STEP7 步驟7

Check the center of gravity (CG) and adjust component placement until CG point is right on the main shaft of the helicopter.

檢視直昇機重心是否適當請先調整直昇機重心位置至主軸中心線下方位置。

### STEP8 步驟8

With all above steps checked, restart the system and begin flight test.

確定所有功能正常，重新開機，完成開機程序後進入飛行測試。

Swashplate correction direction

十字盤修正方向

Helicopter tilting direction

機體傾斜方向

Helicopter tilting direction

機體傾斜方向

## HELICOPTER CG CHECK PROCEDURE 直昇機機體重心檢視方式

After installed the battery, hold the helicopter as shown. Once the helicopter stops rotating, the helicopter's CG can be seen at where the head is pointing relative to the main shaft.

電池固定後，將直昇機如圖示舉起，等待直昇機停止轉動後檢視機頭方向，正確重心應落在機身（主軸附近）位置。

Adjust the frame's CG within +/- 60 degrees from level.

以水平線上下夾角 60° 內為適當的範圍來調整機體的重心。

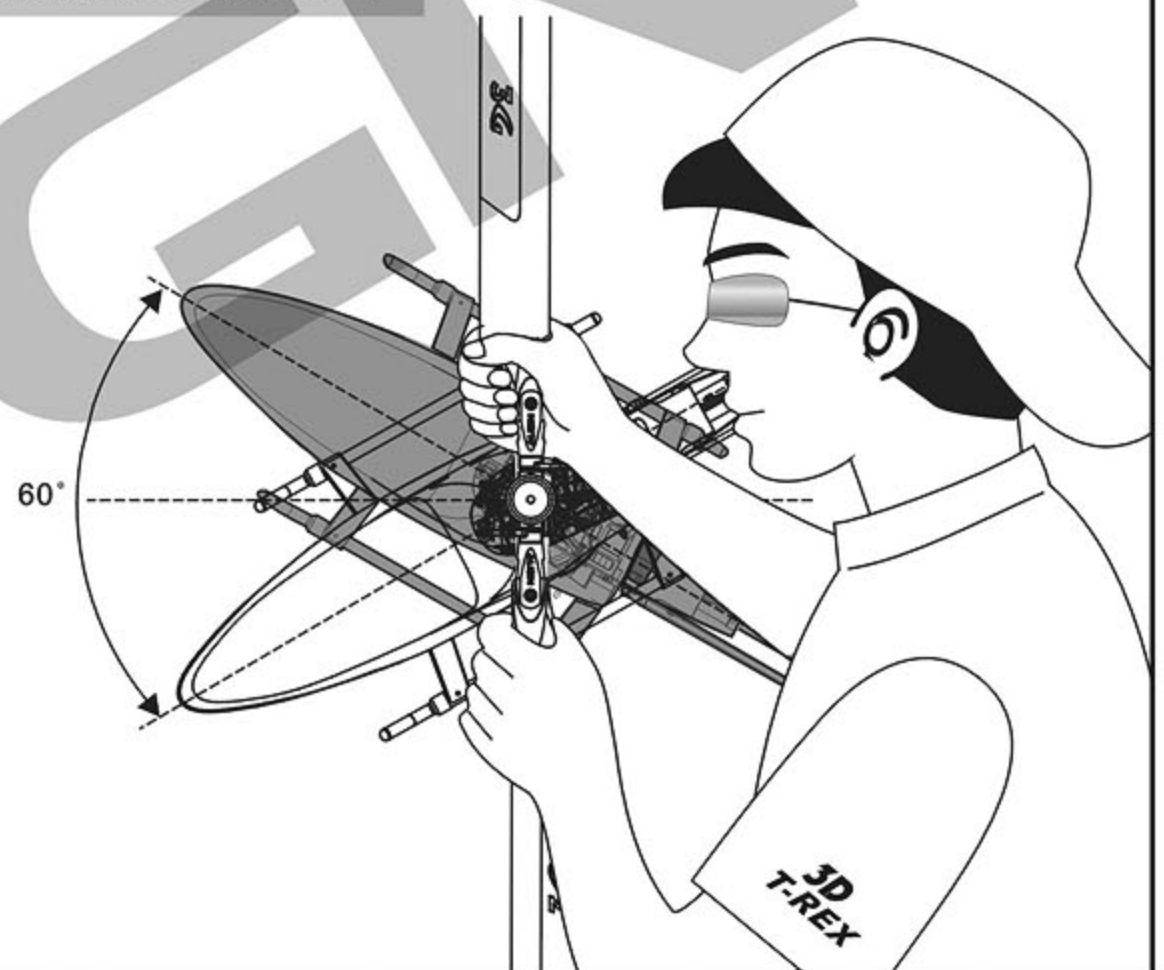

## 6. FLIGHT ADJUSTMENT AND SETTING 飛行動作調整與設定

ALIGN

### PLEASE PRACTICE SIMULATION FLIGHT BEFORE REAL FLYING 飛行前請事先熟練電腦模擬飛行

A safe and effective practice method is to use the transmitter flying on the computer through simulator software sold on the market. Do a simulation flight until you familiarize your fingers with the movements of the rudders, and keep practicing until the fingers move naturally.





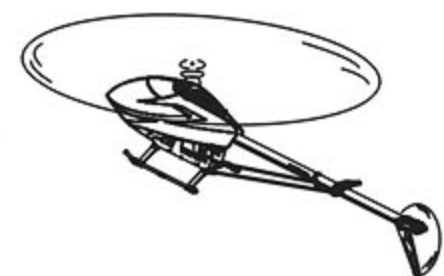

1. Place the helicopter in a clear open field ( Make sure the power OFF ) and the tail of helicopter point to yourself.
2. Practice to operate the throttle stick (as below illustration) and repeat practicing "Throttle high/low", "Aileron left/right", "Rudder left/right", and "Elevator up/down".
3. The simulation flight practice is very important, please keep practicing until the fingers move naturally when you hear operation orders being call out.

在還沒瞭解直昇機各動作的操控方式前，嚴禁實機飛行，請先進行電腦模擬飛行的練習，一種最有效、最安全的練習方式，就是透過市面販售的模擬軟體，以遙控器在電腦上模擬飛行，熟悉各種方向的操控，並不斷的重複，直到手指可熟練的控制各個動作及方向。

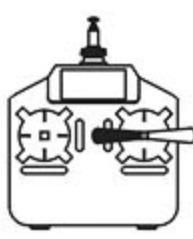
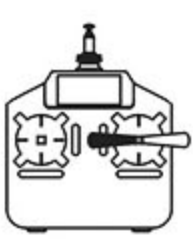
1. 將直昇機放在空曠的地方(確認電源為關閉)，並將直昇機的機尾對準自己。
2. 練習操作遙控器的各搖桿(各動作的操作方式如下圖)，並反覆練習油門高/低、副翼左/右、升降舵前/後及方向舵左/右操作方式。
3. 模擬飛行的練習相當重要，請重複練習直到不需思索，手指能自然隨著喊出的指令移動控制。

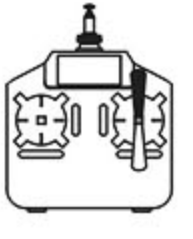
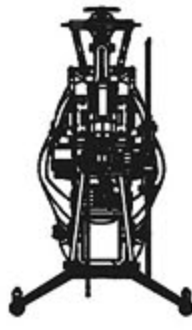

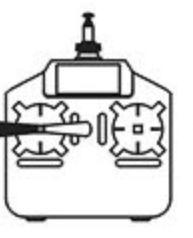
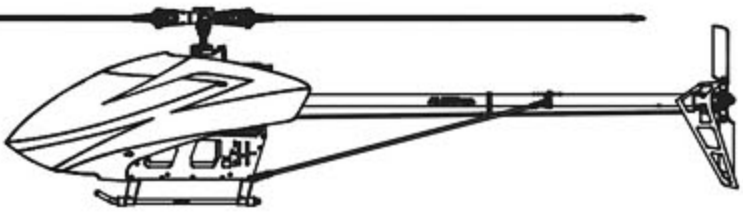
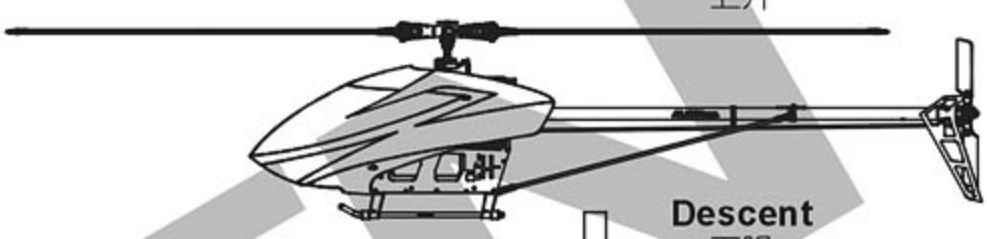
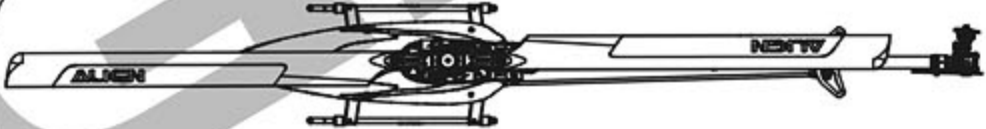

Mode 1	Mode 2	Illustration 圖示
 <p>Aileron 副翼</p> 	 <p>Elevator 升降/前後</p> 	 <p>Move left 左移 Move right 右移 Rotate left 左翻 Rotate right 右翻</p>
 <p>Throttle 油門</p> 	 <p>Rudder 方向</p> 	 <p>Fly forward 前進 Fly backward 後退 Forward rotate 前翻 backward rotate 後翻</p>  <p>Ascent 上升 Descent 下降</p>  <p>Turn right 右旋 Turn left 左旋</p>

## FLIGHT ADJUSTMENT AND NOTICE 飛行調整與注意



- ⊙ Check if the screws are firmly tightened.
- ⊙ Check if the transmitter and receivers are fully charged.
- ⊙ 再次確認→螺絲是否鎖固?
- ⊙ 發射器和接收器電池是否足夠。

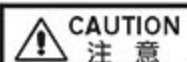

If there are other radio control aircraft at the field, make sure to check their frequencies and tell them what frequency you are using. Frequency interference can cause your model, or other models to crash and increase the risk of danger.

假使飛行場有其他遙控飛機，請確認他們的頻率，並告知他們您正在使用的頻率，相同的頻率會造成干擾導致失控和大大地增加風險。

- ★ When arriving at the flying field.
- ★ 當抵達飛行場

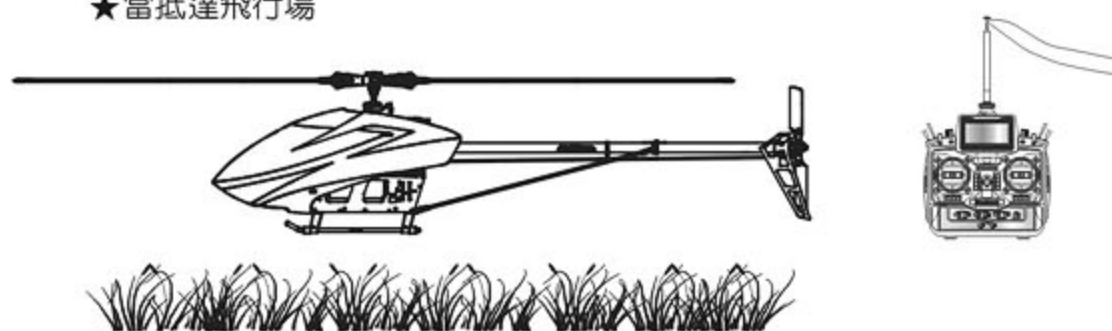

## STARTING AND STOPPING THE MOTOR 啟動和停止馬達



First check to make sure no one else is operating on the same frequency. Then place the throttle stick at lowest position and turn on the transmitter.

首先確認附近沒有其他相同頻率的使用，然後打開發射器將油門搖桿推到低點。

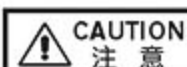

Check if the throttle stick is set at the lowest position.

確認油門搖桿是在最低的位置。

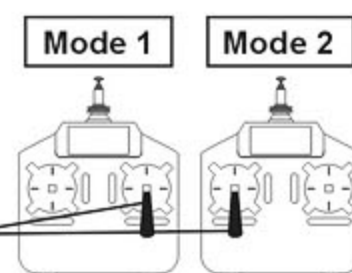

- ★ Check the movement.
- ★ 動作確認



**ON! Step1**  
First turn on the transmitter.  
先開啟發射器



**ON! Step2**  
Connect to the helicopter power  
接上直昇機電源

- ⊙ Are the rudders moving according to the controls?
- ⊙ Follow the transmitter's instruction manual to do a range test.
- ⊙ 方向舵是否隨著控制方向移動?
- ⊙ 根據發射器說明書進行距離測試。



**OFF! Step3**  
Reverse the above orders to turn off.  
關閉電源時請依上述操作動作反執行。



This procedure is best performed on soft surfaces such as grass. The use of rubber skid stopper is recommended on hard surface to prevent vibration feedback from the ground to 3GX, resulting in over-corrections.

將直昇機置於柔軟地面上，建議硬地起飛腳架裝上避震墊圈。避免升空前腳架與過硬的地面震動太大反饋至機身上的3GX，影響無平衡翼系統升空前過度修正。

Rubber skid stoppers installed  
裝上避震墊圈



CAUTION  
注意

If swashplate should tilt prior to lift off, do not try to manually trim the swashplate level. This is due to vibration feedback to the 3GX, and will disappear once helicopter lifts off the ground. If manual trim is applied, helicopter will tilt immediately after liftoff. 直昇機離地前，十字盤可能因3GX受震動的反饋，使十字盤有傾斜的情形，此時請勿刻意將十字盤修正為水平狀態，此現象只要離地升空時立即解除，可平穩升空；若刻意將十字盤修正為水平時，反而會造成感應器過度修正，一離地即偏往修正方向的危險。

## MAIN ROTOR ADJUSTMENTS 主旋翼雙槳平衡調整

1. Before adjusting, apply a red piece of tape on one blade, or paint a red stripe with a marker or paint to identify on blade.
2. Raise the throttle stick slowly and stop just before the helicopter lifts-off ground. Look at the spinning blades from the side of the helicopter.
3. Look at the path of the rotor carefully. If the two blades rotate in the same path, it does not need to adjustment. If one blade is higher or lower than the other blade, adjust the tracking immediately.

1. 調整前先在其中一支主旋翼的翼端，貼上有顏色的貼紙或畫上顏色記號，方便雙槳調整辨識。

2. 慢慢的推起油門搖桿到高點並且停止，在飛機離開地面前，從飛機側邊觀察主旋翼轉動。

3. 仔細觀察旋翼軌跡(假如兩支旋翼移動都是相同軌跡，則不需要調整;可是如果一支旋翼較高或較低產生“雙槳”的情形時，則必須立刻調整軌跡)。

A. When rotating, the blade with higher path means the pitch too big. Please shorten DFC ball link for regular trim.

B. When rotating, the blade with lower path means the pitch too small. Please lengthen DFC ball link for regular trim.

A. 旋翼轉動時較高軌跡的主旋翼表示螺距(PITCH)過大，請調短DFC連桿頭修正。

B. 旋翼轉動時較低軌跡的主旋翼表示螺距(PITCH)過小，請調長DFC連桿頭修正。

CAUTION  
注意

Tracking adjustment is very dangerous, so please keep away from the helicopter at a distance of at least 10m.

調整軌跡非常危險，請於距離飛機最少10公尺的距離。

Incorrect tracking may cause vibrations. Please repeat adjusting the tracking to make sure the rotor is correctly aligned. After tracking adjustment, please check the pitch angle is approx.  $+5\sim 6^\circ$  when hovering.

不正確的旋翼軌跡會導致震動，請不斷重複調整軌跡，使旋翼軌跡精準正確。

在調整軌跡後，確認一下Pitch角度在停旋時應為大約 $+5\sim 6^\circ$ 。

Color mark 有標示記號的主旋翼

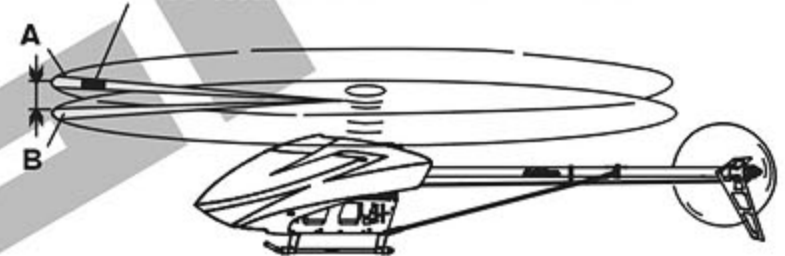

## FLIGHT ADJUSTMENT AND NOTICE 飛行調整與注意

During the operation of the helicopter, please stand approximately 10M diagonally behind the helicopter.

飛行時，請站在直昇機後方最少10公尺。

CAUTION  
注意

- Make sure that no one or obstructions in the vicinity.
- For flying safety, please carefully check if every movement and directions are correct when hovering.
- 確認鄰近地區沒有人和障礙物。
- 為了飛行安全，您必須先確認停懸時各項操控動作是否正常。

CAUTION  
注意

Do not attempt until you have some experiences with the operation of helicopter.  
嚴禁無熟練操控飛行經驗者操控飛行。

### STEP 1 THROTTLE CONTROL PRACTICE 油門控制練習

When the helicopter begins to lift-off the ground, slowly reduce the throttle to bring the helicopter back down. Keep practicing this action until you control the throttle smoothly.

當直昇機開始離地時，慢慢降低油門將飛機降下。持續練習飛機從地面上的上升和下降直到您覺得油門控制很順。

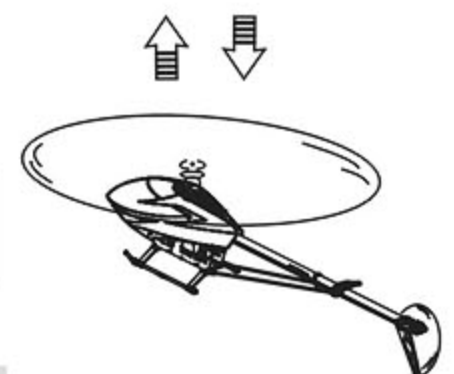
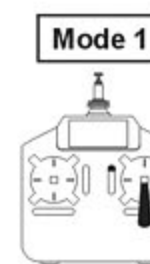

### STEP 2 AILERON AND ELEVATOR CONTROL PRACTICE 副翼和升降控制練習

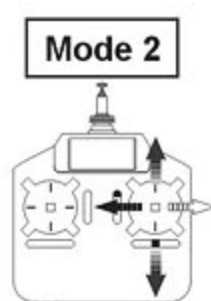
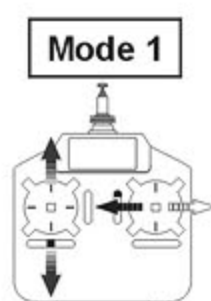

1. Raise the throttle stick slowly.
2. Move the helicopter in any direction back, forward, left and right, slowly move the aileron and elevator sticks in the opposite direction to fly back to its original position.

1. 慢慢升起油門搖桿。

2. 使直昇機依指示:移動向後/向前/向左/向右，慢慢的反向移動副翼和升降搖桿並將直昇機開回到原來位置。

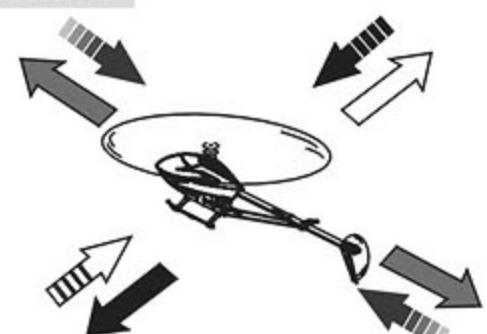

CAUTION  
注意

If the nose of the helicopter moves, please lower the throttle stick and land the helicopter. Then move your position diagonally behind the helicopter 10M and continue practicing.

If the helicopter flies too far away from you, please land the helicopter and move your position behind 10M and continue practicing.

當直昇機機頭偏移時，請降低油門並且降落，然後移動自己的位置到直昇機的正後方10公尺再繼續練習。

假如直昇機飛離你太遠，請先降落直昇機，並到直昇機後10公尺再繼續練習。



### STEP 3 RUDDER CONTROL PRACTICING 方向舵操作練習

1. Slowly raise the throttle stick.
2. Move the nose of the helicopter to right or left, and then slowly move the rudder stick in the opposite direction to fly back to its original position.

1. 慢慢升起油門搖桿。
2. 將直昇機機頭移動左或右，然後慢慢反向移動方向舵搖桿並將直昇機飛回原本位置。

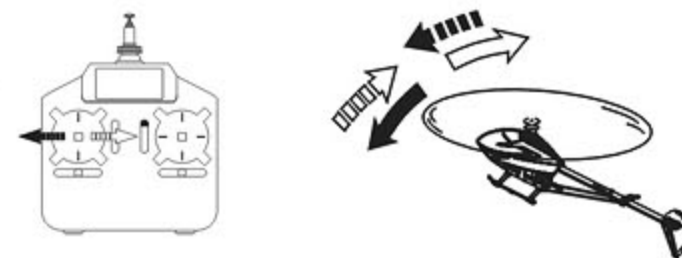

### STEP 4

After you are familiar with all actions from Step 1 to 3, draw a circle on the ground and practice within the circle to increase your accuracy.

當您覺得 step 1~3 動作熟悉了，在地上畫圈圈並在這個圈圈的範圍內練習飛行，以增加您操控的準確度。

- ◎ You can draw a smaller circle when you get more familiar with the actions.
- ◎ 當您更加習慣操作動作，您可以畫更小的圈圈。



### STEP 5 DIRECTION CHANGE AND HOVERING PRACTICE 改變直昇機方向和練習停旋

After you are familiar with Step 1 to 4, stand at side of the helicopter and continue practicing Step 1 to 4. Then repeat the Step 1 to 4 by standing right in front of the helicopter.

當您覺得 step 1~4 動作熟悉了，站在面對直昇機側邊並繼續練習 step 1~4。之後，站在直昇機機頭右邊重複步驟練習。

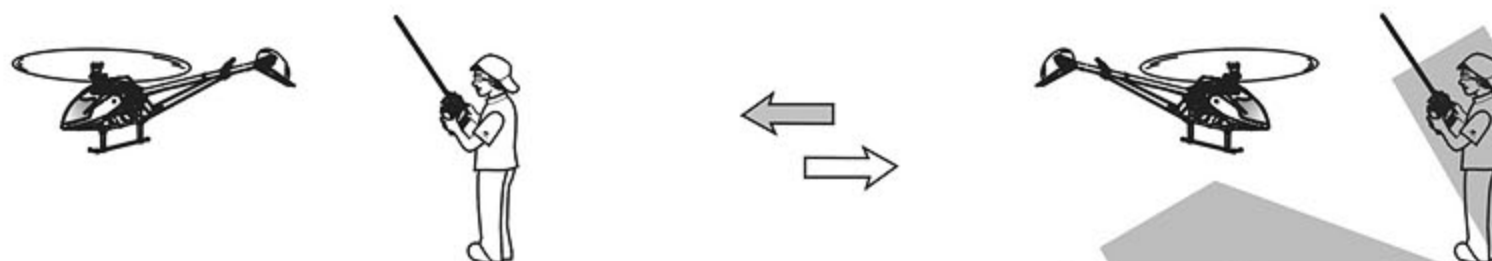

## 7. 3GX FLYBARLESS FLIGHT TEST PROCEDURE 飛行測試程序

**ALIGN**

With the helicopter hovering, observe for any rapid left/right or forward/aft oscillations. If forward/aft oscillation is observed, land the helicopter, turn the ELE gain dial counterclockwise gradually, and test again. Do this until oscillation disappears.

先將直昇機以停懸飛行，觀察直昇機左右及前後是否有不正常快速抖動現象，如果前後有抖動情形，則逆時針調降升降舵感度調整旋鈕，以減少陀螺儀前後修正感度。

SET THE DIAL TO 12 O'CLOCK POSITION AS STARTING POINT 建議初次飛行設於12點鐘方向

Elevator gain adjustment dial  
升降舵感度調整旋鈕

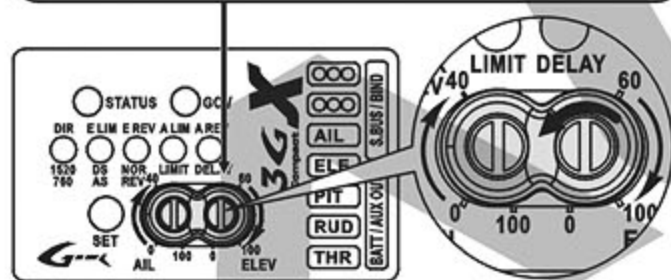

Decrease ELE gain  
調降ELE感度



If left/right oscillation is observed, land the helicopter, turn the AIL gain dial counterclockwise gradually, and test again. Do this until oscillation disappears.

如果為左右抖動，逆時針調降副翼感度調整旋鈕，以減少陀螺儀左右修正感度。

SET THE DIAL TO 12 O'CLOCK POSITION AS STARTING POINT 建議初次飛行設於12點鐘方向

Aileron gain adjustment dial  
副翼感度調整旋鈕

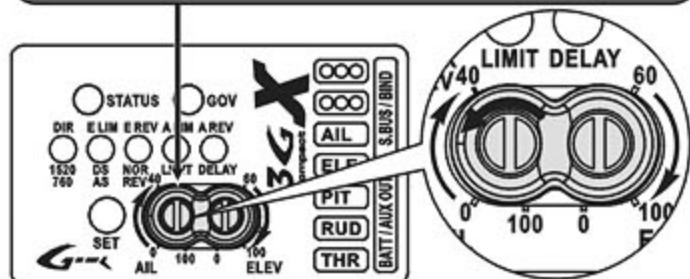

Decrease AIL gain  
調降AIL感度



Left/right oscillation  
左右晃動

### FORWARD STRAIGHT LINE FLIGHT 前進直線航道飛行

After hovering, proceed to fast forward flight. Should there be similar oscillation, please reduce elevator gain. Should the helicopter pitch up or experience slow response during flight, increase elevator gain. Repeat this process until ideal gain value is achieved. Similar method is used to set the aileron gain. After adjusting gyro gains, adjust the roll rate in 3GX Flight Mode settings based on your preference. Higher the roll rate, the faster the roll/flips are. Pilot can also adjust the cyclic EXP setting for the preferred stability. After all adjustments are complete, the pilot can enjoy the stability of slow flight and the fast agility from flybarless system.

停懸完後可快速前進飛行，同樣的如果有不正常抖動時，請將升降舵感度調小，飛行時如果有機頭向上仰起或反應緩慢現象時，請將感度調大，重複測試將感度調整至最理想值，同樣方式可調整副翼感度旋鈕。調整完陀螺儀感度，可依據飛行習慣進入3GX飛行特性設定調整滾轉速率，調整越大，前後及左右滾轉速度越快，使用者也可依據個人經驗調整舵面EXP以增加停旋穩定性。完成所有調整後，就可享受Flybarless所提供低速飛行的穩定性及高速時的靈活性。



Forward Flight  
前進飛行



	Problem 狀況	Cause 原因	Solution 對策
Blade Tracking 雙槳平衡	Tracking is Off 雙槳	Pitch linkage rods are not even length PITCH 連桿長度調整不平均	Adjust length of DFC ball link. 調整 DFC 連桿頭長度
Hover 停懸	Headspeed too low 主旋翼轉速 偏低	Excessive pitch 主旋翼的 PITCH 偏高	Adjust DFC ball link to reduce pitch by 4 to 5 degrees. Hovering headspeed should be around 1450RPM. 調整 DFC 連桿頭調低 Pitch 約 + 4~5 度 (停懸時主旋翼需為約 1450RPM)
		Hovering throttle curve is too low 停懸點油門曲線過低	Increase throttle curve at hovering point on transmitter (around 60%) 調高停懸點油門曲線 (約 60%)
	Headspeed too high 主旋翼轉速 偏高	Not enough pitch 主旋翼的 PITCH 偏低	Adjust DFC ball link to increase pitch by 4 to 5 degrees. Hovering headspeed should be around 1450RPM. 調整 DFC 連桿頭調高 Pitch 約 + 4~5 度 (停懸時主旋翼需為約 1450RPM)
		Hovering throttle curve is too high 停懸點油門曲線過高	Decrease throttle curve at hovering point on transmitter (around 60%) 調低停懸點油門曲線 (約 60%)
Rudder Response 尾舵反應	Drifting of tail occurs during hovering or delay of rudder response when centering rudder stick. 停懸時尾翼向某一邊偏移，或撥動方向舵並回復到中立點時，尾翼產生延遲，無法停頓在所控制位置上。	Rudder neutral point improperly set 尾中立點設定不當	Reset rudder neutral point 重設尾中立點
	Tail oscillates (hunting, or wags) at hover or full throttle 停懸或全油門時尾翼左右來回搖擺。	Rudder gyro gain too low 尾舵陀螺儀感度偏低	Increase rudder gyro gain 增加尾舵陀螺儀感度
Oscillation during flight 飛行抖動	Forward/aft oscillation when elevator is applied 升降舵打舵動作時，機體前後抖動	Elevator gyro gain too high. 升降舵陀螺感度偏高，產生追蹤現象	Turn the ELE gain dial on control box counterclockwise, 10 degrees at a time until oscillation is eliminated. 逆時針調整控制器上的升降舵感度調整旋鈕，以每次調整約 10 度的方式，調整至適當位置
	Helicopter front bobbles (nods) during forward flight. 直線飛行時，機頭點頭	Worn servo, or slack in control links 伺服器老化，控制結構有虛位	Replace servo, ball link, or linkage balls. 更換伺服器、連桿頭、球頭
	Left/right oscillation when aileron is applied 副翼打舵動作時，機體左右抖動	Aileron gyro gain too high 副翼陀螺感度偏高，產生追蹤現象	Turn the AIL gain dial on control box counterclockwise, 10 degrees at a time until oscillation is eliminated. 逆時針調整控制器上的副翼感度調整旋鈕，以每次調整約 10 度的方式，調整至適當位置
	Elevator input causes helicopter to drift 升降舵動作飄移	Worn servo, or slack in control links 伺服器老化，控制結構有虛位	Replace servo, ball link, or linkage balls. 更換伺服器、連桿頭、球頭
Drifting during flight 飛行飄移	Helicopter pitches up during forward flight 直線飛行機頭上揚	Elevator gyro gain too low 升降舵陀螺感度偏低	Turn the ELE gain dial on control box clockwise, 10 degrees at a time until drifting is eliminated. 順時針調整控制器上的升降舵感度調整旋鈕，以每次調整約 10 度的方式，調整至適當位置
	Aileron input causes helicopter to drift 副翼動作飄移	Aileron gyro gain too low 副翼陀螺感度偏低	Turn the AIL gain dial on control box clockwise, 10 degrees at a time until drifting is eliminated. 順時針調整控制器上的升降舵感度調整旋鈕，以每次調整約 10 度的方式，調整至適當位置
Control Response 動作反應	Slow Forward/Aft/Left/Right input response 前後左右飛行動作反應偏慢	Roll rate too low 滾轉速率偏低	Adjust roll rate within 3GX Flight Mode setting. 調整 3GX 飛行特性設定內的滾轉速率值
	Sensitive Forward/Aft/Left/Right input response 前後左右飛行動作反應偏快	Roll rate too high 滾轉速率偏快	Adjust roll rate within 3GX Flight Mode setting. 調整 3GX 飛行特性設定內的滾轉速率值

If above solution does not resolve your issues, please check with experienced pilots or contact your Align dealer.

※在做完以上調整後，仍然無法改善情況時，應立即停止飛行並向有經驗的飛手諮詢或連絡您的經銷商。



**Q&A 1** **Pitches up during fast forward flight.**  
 (1) Elevator gyro gain too low, increase the elevator gain by gradually turning the ELE dial clockwise.  
 (2) Elevator trim not centered. Check if helicopter is tilting backwards during hover.  
 快速飛行時直昇機機頭會上揚？  
 (1) ELE感度不足，請稍微將ELE感度旋鈕順時針方向調高。  
 (2) ELE中立點不對，請測試停懸時，直昇機中立點是否朝後。

**Q&A 2** **Insufficient gain during flight, but increasing gain results in oscillation.**  
 (1) Check and resolve possible mechanical vibration from helicopter.  
 (2) Use softer 3GX mounting foam, or double up the stock 3GX foam.  
 (3) Relocate the 3GX to location less prone to vibration.  
 飛行時感度不足，將感度調高直昇機卻會抖動？  
 (1) 檢查直昇機是否有異常震動，如果是請先修復機體。  
 (2) 用材質較軟或兩片雙面膠泡棉固定3GX。  
 (3) 將3GX換裝於直昇機較不震動的位置。

**Q&A 3** **Drifting during 3D maneuvers.**  
 (1) Increase AIL and ELE gain by turning both dials clockwise.  
 (2) Check if cyclic servos are too slow (minimum 0.08sec / 60 degrees)  
 3D飛行時有飄移現象？  
 (1) 將升降與副翼感度旋鈕順時針方向調高。  
 (2) 檢查推動十字盤的伺服器是否過慢（建議選擇動作速度0.08sec/60度以內規格）。

**Q&A 4** **Unstable hover, control inputs are too sensitive.**  
 Can adjust the roll rate within 3GX Flight Mode settings, as well as increase the EXP setting to increase hovering stability. For CCPM machines, decrease swashplate mixing percentage on the transmitter. In addition, exponential can be added to aileron and elevator channels.  
 停懸時不穩定，有動作過靈敏現象？  
 可調低3GX飛行格各設定內的滾轉速率值，並增加EXP的設定，以提高停懸的穩定性。

**Q&A 5** **Helicopter oscillates after fast forward flight or after tumbles.**  
 (1) Gradually reduce both AIL and ELE gain by turning them counterclockwise, 10 degrees at a time.  
 (2) Use harder head dampener.  
 直昇機高速飛行或滾轉後停止時，機身會有輕微抖動現象？  
 (1) 逆時針調整3GX上的升降舵感度調整旋鈕，以每次調整約10度的方式，調整至適當位置。  
 (2) 主旋翼橫軸及主軸連結的橡膠過軟，請換用較硬的橡膠。

**Q&A 6** **While in flybarless setup mode, unable to complete ELE/AIL endpoint and reverse settings.**  
 Disable all trims/subtrims on the transmitter.  
 進入Flybarless設定，無法順利完成ELE、AIL行程、ELE或AIL的REV燈號？  
 未取消遙控器的內外微調。

**Q&A 7** **Incorrect CCPM mixing after initial flybarless setup.**  
 (1) Trim/subtrims not zeroed out on transmitter.  
 (2) After any trim adjustments are done on transmitter, the initial flybarless setup procedure need to be performed again.  
 (3) Please turn off the swash ring, Linkage Compensation, Swash Mix, Mixing, Acceleration and other collective mixing functions in the transmitter.  
 完成Flybarless設定，但CCPM混控動作不正常？  
 (1) 進入Flybarless設定時未將外微調歸零。  
 (2) 遙控器變更內微調，未重新進行Flybarless設定。  
 (3) 請關閉遙控器內Swash ring、Linkage Compensation、Swash Mix、Mixing、Acceleration等混控功能。

**Q&A 8** **3GX flybarless system unable to power up.**  
 (1) Check proper voltage source.  
 (2) Check AIL/ELE/PIT connections between flybarless control unit and receiver.  
 (3) Check the power connection of 3GX and receiver.  
 3GX Flybarless無法開機？  
 (1) 檢查系統電源是否正常。  
 (2) 檢查AIL、ELE及PIT的訊號線和接收器是否正常連接。  
 (3) 檢查3GX與接收器間電源線是否正常連接。

**Q&A 9** **3GX flybarless system powers up with LED flashing, but swashplate did not jump 3 times, pitch is locked, unable to complete the initialization process.**  
 (1) Possible movement during initialization process. Make sure helicopter is absolutely stationary.  
 (2) If STATUS LED flashes red, check the connection between controller and receiver.  
 3GX Flybarless開機後閃燈正常，十字盤未跳動，PIT被鎖定，無法順利完成開機動作？  
 (1) 開機時直昇機必須完全靜止，才可順利開機。  
 (2) 檢查如果STATUS紅綠燈號一直閃爍，請檢查遙控器與接收器是否正常。

**Q&A 10** **I noticed swashplate tilts slightly at extreme pitch due to servo interactions, should I make efforts to level it out?**  
 No. Level the swashplate at 0 degrees using subtrims ONLY in DIR setup mode. (please refer to page 6 step1.3)  
 End point swashplate interactions are automatically compensated by the 3GX system while in flight.  
 十字盤移動到最高與最低位置時會有些微傾斜，我能嘗試將它修正調整到水平嗎？  
 否。在DIR模式時利用內微調(Subtrims)將十字盤0度時調整至水平(參閱第6頁 步驟1.3)，實際飛行時，3GX系統會自動修正十字盤的混控位差。

**Q&A 11** **What adjustments can I make on the transmitter after the DIR setup has been completed?**  
 You can adjust the trim tabs, dual rates, exponential, collective pitch.  
 在離開DIR模式後，有哪些調整功能是我能使用的？  
 一般開機模式下，您仍然可以使用以下幾個功能調整直昇機：舵面大小動(dual rates, exponential)、集體螺距(collective pitch)。

**Q&A 12** **During step 5 of DIR setup mode, only aileron swash mixing was mentioned. Should I set elevator swash mixing as well?**  
 No. The 3GX system automatically calculates a cyclic ring based on the aileron swash mix percentage. Setting of elevator swash mix has no affect on the 3GX system. Set the cyclic pitch by the aileron swash mix & just use the same value for elevator.  
 在步驟五-循環螺距設定時，為何只測量副翼的角度？  
 3GX系統在實際飛行時，會自動給定十字盤一個限圈運行，所以在測量副翼循環螺距角度後，設定相同數值的升降循環角度即可。



www.align.com.tw  
www.align.com.tw  
www.align.com.tw  
www.align.com.tw  
www.align.com.tw  
www.align.com.tw  
www.align.com.tw

# ALIGN