

MODEL 57076-1



**SPARTAN**™

**TRAXXAS**®

OWNER'S MANUAL

- 3 BEFORE YOU PROCEED
- 4 SAFETY PRECAUTIONS
- 6 TOOLS, SUPPLIES AND REQUIRED EQUIPMENT
- 7 ANATOMY OF THE SPARTAN
- 8 QUICK START: GETTING UP TO SPEED
- 9 TQi RADIO & BRUSHLESS POWER SYSTEM
- 17 ADJUSTING THE ELECTRONIC SPEED CONTROL
- 19 DRIVING YOUR MODEL
- 20 ADJUSTING YOUR MODEL
- 22 MAINTAINING YOUR MODEL
- 24 TROUBLESHOOTING
- 25 TQi ADVANCED TUNING GUIDE

The Traxxas Spartan raises the bar for reliable, high-performance RC boating. Never before has there been an R/C boat with 50+mph speed, waterproof electronics, stable handling, and the run-after-run ruggedness you expect from Traxxas—all in a Ready-To-Race® package with stunning, factory-applied graphics. The Spartan is powered by an all-new brushless speed control and motor system developed specifically for high-performance marine use. The long-range TQi radio system keeps you in control with switch-on-and-drive convenience. Stainless-steel turn fins and trim tabs allow stable, precise handling. The machined-aluminum drive strut and rudder assembly channel brushless power directly into the water for incredible speed, aggressive cornering, and blistering acceleration with a cascading roost that lets everyone know you've got the wildest ride on the water.

Please keep in mind that this boat is not a toy, and is not intended to be used by children without responsible adult supervision. This is due to the inherent dangers that are always associated with any body of water. Please respect the water and use extreme caution when launching and retrieving boats. We're confident that you will enjoy the power, speed, and reliability that the Spartan has to offer.

We know you're excited about getting your new model in the water, but it's very important that you take some time to read through the Owners Manual. This manual contains all the necessary set-up and operating procedures that allow you to unlock the performance and potential that Traxxas engineers designed into your model. **Even if you are an experienced R/C enthusiast, it's important to read and follow the procedures in this manual.**

We want you to feel confident that you own one of the best-performing models in the market and that it is backed by a team

of professionals who aim to provide the highest level of factory support possible. Traxxas models are about experiencing total performance and satisfaction, not just with your model, but also with the company that stands behind it. We truly want you to enjoy your new model!

Thank you again for going with Traxxas.

### Traxxas Support

Traxxas support is with you every step of the way. Refer to the next page to find out how to contact us and what your support options are.



### Quick Start

This manual is designed with a Quick Start path that outlines the necessary procedures to get your model up and running in the shortest time possible. If you are an experienced R/C enthusiast you will find it helpful and fast. Be sure and read through the rest of the manual to learn about important safety, maintenance, and adjustment procedures. Turn to page 8 to begin.



### REGISTERING YOUR MODEL

**In order to serve you better as our customer, please register your product within 10 days of your purchase online at [Traxxas.com/register](https://www.traxxas.com/register).**

[Traxxas.com/register](https://www.traxxas.com/register)

#### FCC Compliance

This device contains a module that complies with the limits for a Class B digital device as described in part 15 of the FCC rules. Operation is subject to the following two conditions: (1) This device may not cause harmful interference, and (2) this device must accept any interference received, including interference that may cause undesired operation.

The limits for a Class B digital device are designed to provide reasonable protection against harmful interference in residential settings. This product generates, uses and can radiate radio frequency energy, and, if not operated in accordance with the instructions, may cause harmful interference to radio communications. The user is cautioned that changes or modifications not expressly approved by the party responsible for compliance could void the user's authority to operate the equipment.

#### Canada, Industry Canada (IC)

This Class B digital apparatus complies with Canadian ICES-003 and RSS-210. This device complies with Industry Canada license exempt RSS standard(s). Operation is subject to the following two conditions: This device may not cause interference, and this device must accept any interference, including interference that may cause undesired operation of the device.

#### Radio Frequency (RF) Exposure Statement

This equipment complies with radio frequency exposure limits set forth by FCC and Industry Canada for an uncontrolled environment. This equipment should be installed and operated with a minimum distance of 20 centimeters between the radiator and your body or bystanders and must not be co-located or operating in conjunction with any other antenna or transmitter.

## BEFORE YOU PROCEED

Carefully read and follow all instructions in this and any accompanying materials to prevent serious damage to your model. Failure to follow these instructions will be considered abuse and/or neglect.

Before running your model, look over this entire manual and examine the model carefully. If for some reason you decide it is not what you wanted, then do not continue any further. **Your hobby dealer absolutely cannot accept a model for return or exchange after it has been run.**

### Warnings, Helpful Hints, & Cross-References

Throughout this manual, you'll notice warnings and helpful hints identified by the icons below. Be sure to read them!



An important warning about personal safety or avoiding damage to your model and related components.



Special advice from Traxxas to make things easier and more fun.



Refers you to a page with a related topic.

### SUPPORT

If you have any questions about your model or its operation, call the Traxxas Technical Support line toll-free at: **1-888-TRAXXAS (1-888-872-9927)\***

Technical support is available Monday through Friday from 8:30am to 9:00pm central time. Technical assistance is also available at Traxxas.com. You may also e-mail customer support with your question at support@Traxxas.com. Join thousands of registered members in our online community at Traxxas.com.

Traxxas offers a full-service, on-site repair facility to handle any of your Traxxas service needs. Maintenance and replacement parts may be purchased directly from Traxxas by phone or online at BuyTraxxas.com. You can save time, along with shipping and handling costs, by purchasing replacement parts from your local dealer.

Do not hesitate to contact us with any of your product support needs. We want you to be thoroughly satisfied with your new model!

Traxxas  
6250 Traxxas Way  
McKinney, Texas 75070  
Phone: 972-549-3000  
Toll-free 1-888-TRAXXAS

Internet  
Traxxas.com  
E-mail: support@Traxxas.com

Entire contents ©2015 Traxxas. Traxxas, Spartan, Ready-To-Race, Ready-To-Win and ProGraphix are trademarks or registered trademarks of Traxxas. Other brand names and marks are the property of their respective holders and are used only for purposes of identification. No part of this manual may be reproduced or distributed in print or electronic media without the express written permission of Traxxas. Specifications are subject to change without notice.

\*Toll-free support is available to U.S. residents only.



## SAFETY PRECAUTIONS



All instructions and precautions outlined in this manual should be strictly followed to ensure safe operation of your model.



This model is not intended for use by children under 14 years of age without the supervision of a responsible and knowledgeable adult. Battery choice (see *LiPo Batteries, right*) effects the skill level of the model. See chart below.



Batteries: Two 7-Cell NiMH (Stock)  
Voltage\*: 16.8V  
mAh: 3000+mAh



Batteries: Two 2S LiPo  
Voltage\*: 14.8V  
mAh: 5000+mAh



Batteries: Two 3S LiPo  
Voltage\*: 22.2V  
mAh: 5000+mAh

\*Nominal

All of us at Traxxas want you to safely enjoy your new model. Operate your model sensibly and with care, and it will be exciting, safe, and fun for you and those around you. Failure to operate your model in a safe and responsible manner may result in property damage and serious injury. The precautions outlined in this manual should be strictly followed to help ensure safe operation. You alone must see that the instructions are followed and the precautions are adhered to.

### Important Points to Remember

- Do not drive your model at night.
- Never, under any circumstances, operate your model in any water where people are swimming or wading. Your model is fast and could cause injury if allowed to collide with anyone. Avoid running in areas reserved for water fowl!
- Because your model is controlled by radio, it is subject to radio interference from many sources that are beyond your control. Since radio interference can cause momentary loss of radio control, always allow a safety margin in all directions around the boat in order to prevent collisions.
- Do not reach underneath the rear of your model. The propeller could spin unexpectedly. Always pick up the boat from the front or the side.
- Because of the many dangers involved with any body of water, Traxxas recommends that you never try to wade or swim to retrieve the boat. The Boat Retrieval section in this manual outlines safer, alternative methods for boat retrieval.
- Due to the high-performance nature of the electric motor, it can become hot during use. Do not touch the motor when installing and removing battery packs.
- Most importantly, use good, common sense when you are around the water to avoid mishaps, such as slipping on a muddy bank. Always observe water safety rules and regulations.

### Speed Control

Your model's electronic speed control (ESC) is an extremely powerful electronic device capable of delivering high current. Please closely follow these precautions to prevent damage to the speed control or other components.

- **Disconnect the Battery:** Always disconnect the battery or batteries from the speed control when not in use.

- **Insulate the Wires:** Always insulate exposed wiring with heat shrink tubing to prevent short circuits.
- **Transmitter on First:** Switch on your transmitter first before switching on the speed control to prevent runaways and erratic performance.
- **Don't Get Burned:** The ESC and motor can become extremely hot during use, so be careful not to touch them until they cool.
- **Use the Factory-Installed Connectors:** Do not change the battery and motor connectors. Improper wiring can cause fire or damage to the ESC. Please note that modified speed controls can be subject to a rewiring fee when returned for service.
- **No Reverse Voltage:** The ESC is not protected against reverse polarity voltage.
- **No Schottky Diodes:** External Schottky diodes are not compatible with reversing speed controls. Using a Schottky diode with your Traxxas speed control will damage the ESC and void the 30-day warranty.
- Always adhere to the minimum and maximum limitations of the speed control as stated in the specifications table in the Owner's Manual. If your ESC operates on two batteries, do not mix battery types and capacities. Use the same voltage and capacity for both batteries. Using mismatched battery packs could damage the batteries and electronic speed control.

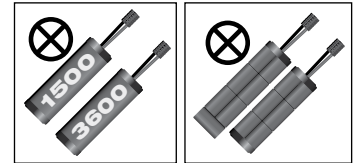

Do not mix battery capacities. Use two batteries with the same capacity.

Do not use a 6-cell 7.2V battery in combination with a 7-cell battery 8.4V pack.

### Batteries and Battery Charging

Your model uses rechargeable batteries that must be handled with care for safety and long battery life. Make sure to read and follow all instructions and precautions for charging and maintaining the batteries. It is your responsibility to charge and care for the battery packs properly. In addition to your battery and charger instructions, here are some more tips to keep in mind.

- Do not charge batteries inside of an automobile. Do not charge batteries while driving in an automobile. The charger is equipped with a long cord intended to allow the battery to be charged outside of an automobile when using the automobile's auxiliary

power socket. If the cord will not reach outside of the automobile, find another power source.

- Never charge batteries on wood, cloth, carpet or on any other flammable material.
- Do not operate the charger in a cluttered space, or place objects on top of the charger or battery.
- If a battery gets hot to the touch during the charging process (temperature greater than 140°F / 60°C), disconnect the battery from the charger and discontinue charging immediately.
- Always store battery packs safely out of the reach of children and pets.
- Do not short-circuit the battery pack. This may cause burns and severe damage to the battery pack and create the risk of fire.
- Do not expose the charger to water or moisture.
- Do not disassemble the charger.
- Use the supplied charger to charge the included battery. See “Charging the Battery Pack” on page 12.
- Never leave batteries to charge unattended.
- Remove the battery from the model while charging.
- Always unplug the battery from the electronic speed control when the model is not in use and when it is being stored or transported.
- Allow the battery pack to cool off between runs (before charging).
- Children should have responsible adult supervision when charging and handling batteries.
- Do not use battery packs that have been damaged in any way.
- Do not use battery packs that have damaged wiring, exposed wiring, or a damaged connector.
- Do not short-circuit the battery pack. This may cause burns and severe damage to the battery pack.
- Do not burn or puncture the batteries. Toxic materials could be released. If eye or skin contact occurs, flush with water.
- Store the battery pack in a dry location, away from heat sources and direct sunlight.
- Nickel Metal Hydride batteries must be recycled or disposed of properly.

### Recycling Your Traxxas Power Cell NiMH Battery

Traxxas strongly encourages you to recycle your Power Cell NiMH battery when it has reached the end of its useful life. **Do not throw your battery in the trash.** All Power Cell NiMH battery packs display the RBRC (Rechargeable Battery Recycling Corporation) icon, indicating they are recyclable. To find a recycling center near you, ask your local hobby dealer or visit [www.call2recycle.org](http://www.call2recycle.org).

### LiPo Batteries

Lithium Polymer (LiPo) batteries are becoming popular for use in R/C models due to their compact size, high energy density, and high-current output. However, these types of batteries require special care and handling procedures for long life and safe operation. **Warning: LiPo batteries are intended only for advanced users that are educated on the risks associated with LiPo battery use. Traxxas does not recommend that anyone under the age of 16 use or handle LiPo battery packs without the supervision of a knowledgeable and responsible adult.**

Your model is able to use LiPo batteries with nominal voltage not to exceed 11.1 volts (3S packs). LiPo batteries have a minimum safe discharge voltage threshold that should not be exceeded. The electronic speed control is equipped with built-in Low-Voltage Detection that alerts the driver when LiPo batteries have reached their minimum voltage (discharge) threshold. It is the driver’s responsibility to stop immediately to prevent the battery pack from being discharged below its safe minimum threshold.

Low-Voltage Detection on the speed control is just one part of a comprehensive plan for safe LiPo battery use. It is critical for you, the user, to follow all other instructions supplied by the battery manufacturer and the charger manufacturer for proper charging, use, and storage of LiPo batteries. Do not attempt to charge LiPo batteries with the Traxxas charger included in this package. Make sure you understand how to use your LiPo batteries. Be aware that Traxxas shall not be liable for any special, indirect, incidental, or consequential damages arising out of the installation and/or use of LiPo batteries in Traxxas models. **If you have questions about LiPo battery usage, please consult with your local hobby dealer or contact the battery manufacturer.** As a reminder, all batteries should be recycled at the end of their useful life.

DO NOT ATTEMPT TO CHARGE LIPO BATTERIES OR ANY OTHER TYPE OF BATTERY WITH THE INCLUDED TRAXXAS CHARGER.

## TOOLS, SUPPLIES AND REQUIRED EQUIPMENT



For more information on batteries, see *Use the Right Batteries* on page 12.



### Recommended Equipment

These items are not required for the operation of your model, but are a good idea to include in any R/C toolbox:

- Safety glasses
- Traxxas Ultra Premium Tire Glue, Part #6468 (CA glue)
- Hobby knife
- Side cutters and/or needle nose pliers
- Philips screwdriver
- Soldering iron

Your model comes with a set of specialty metric tools. You'll need to purchase other items, available from your hobby dealer, to operate and maintain your model.

### Supplied Tools and Equipment



1.5mm "L" wrench

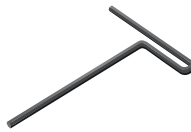

2.0mm "T" wrench



2.5mm "T" wrench

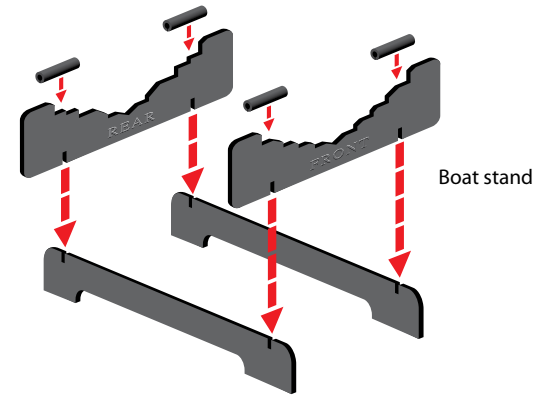

Boat stand



Spare Propeller



4-way wrench



Two 10mm motor coupler wrenches



Two 7-cell NiMH battery packs\*



NiMH battery charger\*

### Required Equipment



4 AA alkaline batteries

\*Battery and charger style are subject to change and may vary from images.

# SPARTAN OVERVIEW

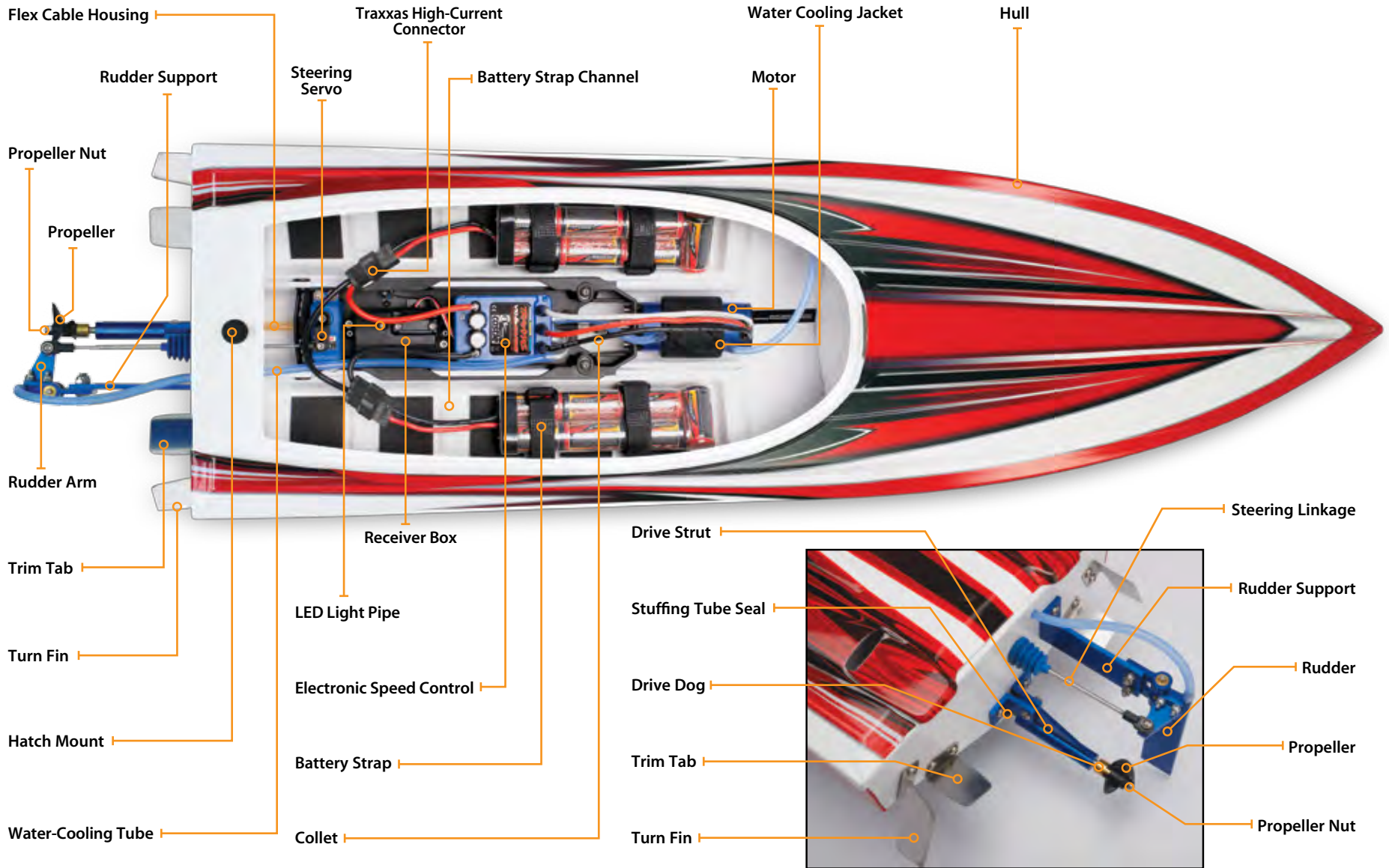

## QUICK START: GETTING UP TO SPEED



The Quick Start Guide is not intended to replace the full operating instructions available in this manual. Please read this entire manual for complete instructions on the proper use and maintenance of your model.

Look for the Quick Start logo at the bottom of Quick Start pages.



The following guide is an overview of the procedures for getting your model running. Look for the Quick Start logo on the bottom corners of Quick Start pages.

**1. Read the safety precautions on page 4**

For your own safety, understand where carelessness and misuse could lead to personal injury.

**2. Charge the battery packs • See page 12**

Charge your batteries (included) now so they will be ready when you finish the other setup procedures.

**3. Install batteries in the transmitter • See page 12**

The transmitter requires 4 AA alkaline batteries (sold separately).

**4. Install battery packs in the model • See page 13**

**5. Turn on the radio system • See page 14**

Make a habit of turning the transmitter on first, and off last.

**6. Check servo operation • See page 15**

Make sure the steering servo is working correctly.

**7. Range test the radio system • See page 15**

Follow this procedure to make sure your radio system works properly at a distance and that there is no interference.

**8. Drive your Spartan • See page 19**

Driving tips and adjustments for your Spartan.

**9. Maintaining your Spartan • See page 22**

Follow these critical steps to maintain the performance of your Spartan and keep it in excellent running condition.



## INTRODUCTION

Your model includes the latest Traxxas TQi transmitter with Traxxas Link™ Model Memory. The transmitter's easy-to-use design provides instant driving fun for new R/C enthusiasts, and also offers a full complement of pro-level tuning features for advanced users – or anyone interested in experimenting with the performance of their model. The steering and throttle channels feature adjustable Exponential, End Points, and Sub-Trims. Steering and braking Dual Rate are also available. Many of the next-level features are controlled by the Multi-Function knob, which can be programmed to control a variety of functions. The detailed instructions (page 25) and Menu Tree (page 27) included in this manual will help you understand and operate the advanced functions of the new TQi radio system. For additional information and how-to videos, visit [Traxxas.com](http://Traxxas.com).

## RADIO AND POWER SYSTEM TERMINOLOGY

Please take a moment to familiarize yourself with these radio and power system terms. They will be used throughout this manual. A detailed explanation of the advanced terminology and features of your new radio system begins on page 25.

**2.4GHz Spread Spectrum** – This model is equipped with the latest R/C technology. Unlike AM and FM systems that require frequency crystals and are prone to frequency conflicts, the TQi system automatically selects and locks onto an open frequency, and offers superior resistance to interference and “glitching.”

**BEC (Battery Eliminator Circuit)** - The BEC can either be in the receiver or in the ESC. This circuit allows the receiver and servos to be powered by the main battery pack in an electric model. This eliminates the need to carry a separate pack of 4 AA batteries to power the radio equipment.

**Brushless Motor** - A D/C brushless motor replaces the brushed motor's traditional commutator and brush arrangement with intelligent electronics that energize the electromagnetic windings in sequence to provide rotation. Opposite of a brushed motor, the brushless motor has its windings (coils) on the perimeter of the motor can and the magnets are mounted to the spinning rotor shaft.

**Current** - Current is a measure of power flow through the electronics, usually measured in amps. If you think of a wire as a garden hose, current is a measure of how much water is flowing through the hose.

**ESC (Electronic Speed Control)** - An electronic speed control is the electronic motor control inside the model. The VXL-6s Marine electronic speed control uses advanced circuitry to provide precise, digital proportional throttle control. Electronic speed controls use power more efficiently than mechanical speed controls so that the batteries run longer. An electronic speed control also has circuitry that prevents loss of steering and throttle control as the batteries lose their charge.

**Frequency band** - The radio frequency used by the transmitter to send signals to your model. This model operates on the 2.4GHz direct-sequence spread spectrum.

**kV Rating** - Brushless motors are often rated by their kV number. The kV rating equals no-load motor rpm with 1 volt applied. The kV increases as the number of wire turns in the motor decreases. As the kV increases, the current draw through the electronics also increases.

**LiPo** - Abbreviation for Lithium Polymer. Rechargeable LiPo battery packs are known for their special chemistry that allows extremely high energy density and current handling in a compact size. These are high performance batteries that require special care and handling. For advanced users only.

**mAh** – Abbreviation for milliamp hour. A measure of the capacity of the battery pack. The higher the number, the longer the battery will last between recharges.

**Neutral position** - The standing position that the servos seek when the transmitter controls are at the neutral setting.

**NiCad** - Abbreviation for nickel-cadmium. The original rechargeable hobby pack, NiCad batteries have very high current handling, high capacity, and can last up to 1000 charging cycles. Good charging procedures are required to reduce the possibility of developing a “memory” effect and shortened run times.

**NiMH** - Abbreviation for nickel-metal hydride. Rechargeable NiMH batteries offer high current handling, and much greater resistance to the “memory” effect. NiMH batteries generally allow higher capacity than NiCad batteries. They can last up to 500 charge cycles. A peak charger designed for NiMH batteries is required for optimal performance.

**Receiver** - The radio unit inside your model that receives signals from the transmitter and relays them to the servos.



To prevent loss of radio range do not kink or cut the black wire, do not bend or cut the metal tip, and do not bend or cut the white wire at the end of the metal tip.

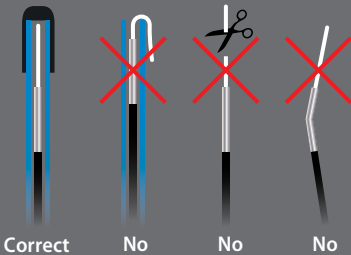

**Resistance** - In an electrical sense, resistance is a measure of how an object resists or obstructs the flow of current through it. When flow is constricted, energy is converted to heat and is lost. The power system is optimized to reduce electrical resistance and the resulting power-robbing heat.

**Rotor** - The rotor is the main shaft of the brushless motor. In a brushless motor, the magnets are mounted to the rotor, and the electromagnetic windings are built into the motor housing.

**Sensored** - Sensored refers to a type of brushless motor that uses an internal sensor in the motor to communicate rotor position information back to the electronic speed control. The VXL-6s Marine electronic speed control is designed for use with sensorless motors.

**Sensorless** - Sensorless refers to a brushless motor that uses advanced instructions from an electronic speed control to provide smooth operation. Additional motor sensors and wiring are not required. The VXL-6s Marine electronic speed control is optimized for smooth sensorless control.

**Servo** - Small motor unit in your model that operates the steering mechanism.

**Solder Tabs** - Accessible, external contacts on the motor that allows for easy wire replacement.

**Transmitter** - The hand-held radio unit that sends throttle and steering instructions to your model.

**Trim** - The fine-tuning adjustment of the neutral position of the servos, made by adjusting the throttle and steering trim knobs on the face of the transmitter. Note: The Multi-Function knob must be programmed to serve as a throttle trim adjustment.

**Thermal Shutdown Protection** - Temperature sensing electronics used in the VXL-6s Marine electronic speed control detect overloading and overheating of the transistor circuitry. If excessive temperature is detected, the unit automatically shuts down to prevent damage to the electronics.

**2-channel radio system** - The TQi radio system, consisting of the receiver, the transmitter, and the servos. The system uses two channels: one to operate the throttle and one to operate the steering.

**Voltage** - Voltage is a measure of the electrical potential difference between two points, such as between the positive battery terminal and ground. Using the analogy of the garden hose, while current is the quantity of water flow in the hose, voltage corresponds to the pressure that is forcing the water through the hose.

#### IMPORTANT RADIO SYSTEM PRECAUTIONS

- Do not kink the receiver's antenna wire. Kinks in the antenna wire will reduce range.
- DO NOT CUT any part of the receiver's antenna wire. Cutting the antenna will reduce range.
- Extend the antenna wire in the model as far as possible for maximum range. It is not necessary to extend the antenna wire out of the body, but wrapping or coiling the antenna wire should be avoided.
- Do not allow the antenna wire to extend outside the body without the protection of an antenna tube, or the antenna wire may get cut or damaged, reducing range. It is recommended to keep the wire inside the body (in the antenna tube) to prevent the chance of damage.

Your model is equipped with the newest Traxxas TQi transmitter with Traxxas Link™ Model Memory. The transmitter has two channels for controlling your throttle and steering. The receiver inside the model has 5 output channels. Your model is equipped with one servo and an electronic speed control.

### TRANSMITTER AND RECEIVER



\*\*Accessory sensor port for use with the Telemetry Expander Module (see Traxxas.com for more information).

### WIRING DIAGRAM

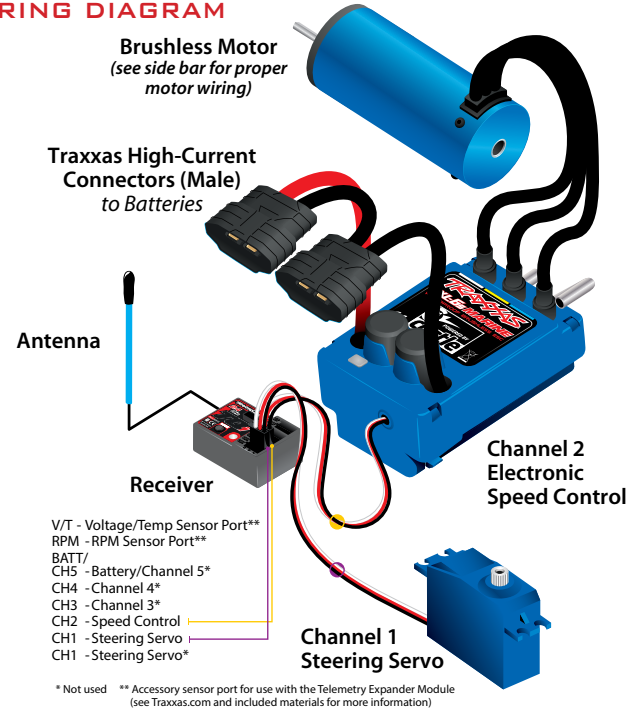

### VXL-6S MARINE ELECTRONIC SPEED CONTROL

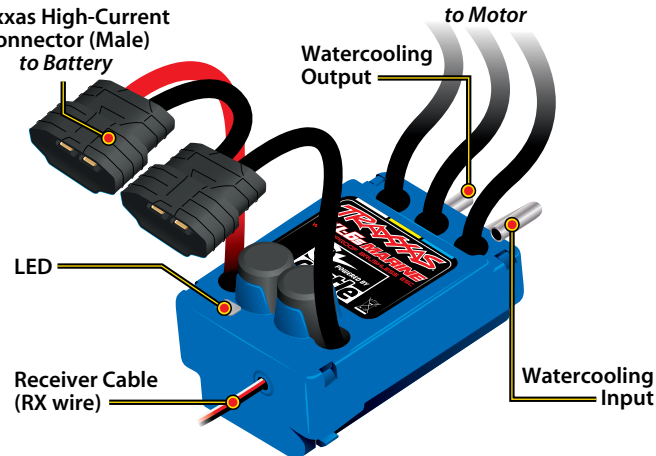

### ESC/Motor Wiring Diagram

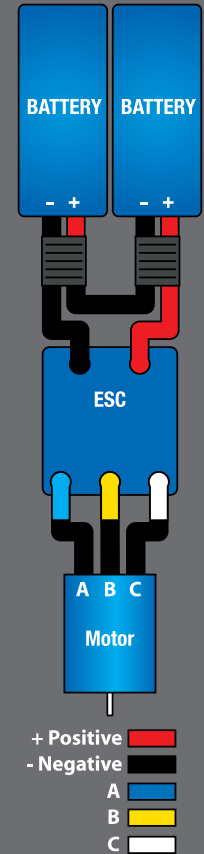

### INSTALLING TRANSMITTER BATTERIES

Your TQi transmitter uses 4 AA batteries. The battery compartment is located in the base of the transmitter.



1. Remove the battery compartment door by pressing the tab and sliding the door open.
2. Install the batteries in the correct orientation, as indicated in the battery compartment.
3. Reinstall the battery compartment door and snap it closed.
4. Turn on the transmitter and check the status indicator for a solid green light.

If the status LED flashes red, the transmitter batteries may be weak, discharged or possibly installed incorrectly. Replace with new or freshly charged batteries. The power indicator light does not indicate the charge level of the battery pack installed in the model.

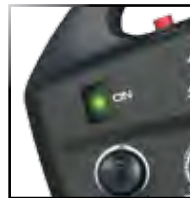

Refer to the troubleshooting section on page 26 for more information on the transmitter Status LED codes.

### CHARGING THE BATTERY PACK

The Traxxas Battery Charger is a fully featured NiMH (Nickle Metal Hydride) charger. It features 4-amp charge current for fast charging and advanced peak detection to optimize every charge. Take this compact charger with you wherever you want to have radio controlled fun! **Do not charge batteries inside of an automobile. Read the Safety Precautions section of this manual.**

1. Plug the charger into a 12-volt automotive auxiliary power socket. The charger is compatible with 12-volt automotive auxiliary power sockets only. The LED on the charger will glow red to indicate it is ready to charge a battery.
2. Connect the battery to begin charging. Plug the battery into the charger. The charger's LED will flash green, indicating that charging has begun. The flashing green LED on the charger indicates the charge progress.
3. Disconnect the battery when charging is complete. The Traxxas 4amp DC charger uses sophisticated voltage-detection circuitry to monitor the battery and automatically stop charging when the pack has reached maximum capacity. When the battery is fully charged, the LED will light solid green. The battery will be warm in your hand. Disconnect the battery.

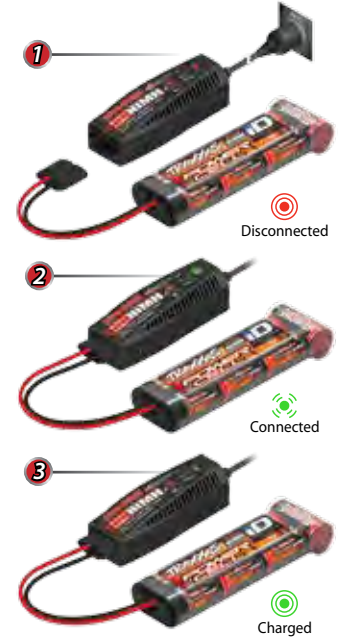

#### CHARGE PROGRESS

★ x1	1 green flash	0 - 25% charged
★ x2	2 green flashes	25% - 50% charged
★ x3	3 green flashes	50% - 75% charged
★ x4	4 green flashes	75% or more charged
●	Solid green LED	100% charged

#### CHARGER LED INDICATION

●	Solid Red LED	Ready for Charging
★	Slowly Flashing Green LED	Charging (see Charge Progress chart)
●	Solid Green LED	Battery Fully Charged
★	Flashing Red LED	Charger error



The included charger is designed for use only with Traxxas NiMH batteries with iD. Legacy Traxxas High-Current Connectors are not compatible with this charger. **DO NOT** try to force legacy connectors into the charge connector.



If the status LED doesn't light green, check the polarity of the batteries. Check rechargeable batteries for a full charge. If you see any other flashing signal from the LED, refer to the chart on page 26 to identify the code.



#### Use the Right Batteries

Your transmitter uses AA batteries. Use new alkaline batteries. Do not use rechargeable AA cells to power the TQi transmitter, as they will not provide sufficient voltage for optimum transmitter performance.

Caution: Discontinue running your model at the first sign of weak batteries (flashing red light) to avoid losing control.



## INSTALLING THE BATTERY PACK

Spartan uses hook-and-loop straps to secure the batteries. To install the batteries, simply loosen the straps, slide the battery pack beneath them, and tighten the straps to hold the batteries snugly against the battery tray's foam pads. They should be tight enough to prevent the batteries from sliding, but should not be pulled excessively tight. If you wish to use other positions in the battery tray, simply remove the straps and reinstall them in the additional channels provided. Assemble the straps as shown in the illustration. (NiMH batteries shown; LiPo batteries install the same).



- **Battery Packs Aft:** Positioning the batteries all the way back in their trays may provide higher top speeds but will also make Spartan more prone to blowing over, spinouts, and instability. Experiment with this position only in very calm conditions, and closely monitor the hull's attitude as you increase speed.

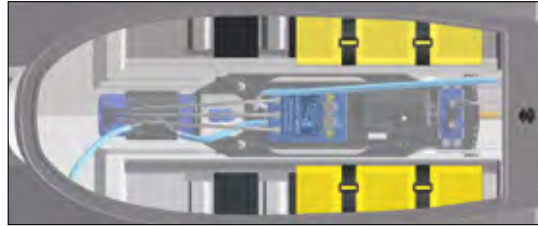

### Positioning the Battery Packs

- **Battery Packs Forward:** This is the standard battery position for Spartan. Placing the battery packs at the front of the battery trays will give Spartan the greatest stability in all water and wind conditions. Whether you are using the provided batteries or aftermarket NiMH or LiPo packs, always begin with the batteries in the forward position.

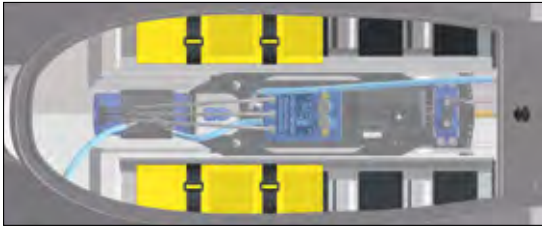

- **Battery Packs Centered:** Smooth water and calm winds may allow you to move the battery packs rearward in the hull to allow the bow to ride higher and increase Spartan's speed. Be aware that positioning the batteries farther aft increases the likelihood of the boat blowing over at speed or becoming unstable.

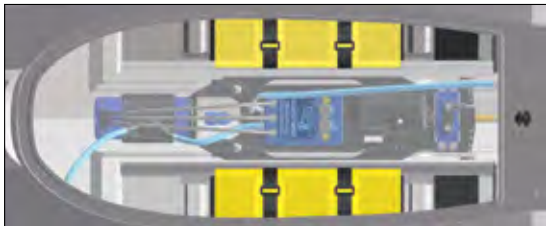

### Battery iD

Your model's included battery pack is equipped with Traxxas Battery iD. This exclusive feature allows Traxxas battery chargers (sold separately) to automatically recognize connected battery packs and optimize the charge settings for the battery. This eliminates the need to worry over charger settings and menus for the easiest and safest charging solution possible. Visit [Traxxas.com](http://Traxxas.com) to learn more about this feature and available Traxxas iD chargers and batteries.



## RADIO SYSTEM CONTROLS



## RADIO SYSTEM RULES

- Always turn your TQi transmitter on first and off last. This procedure will help to prevent your model from receiving stray signals from another transmitter, or other source, and running out of control. Your model has electronic fail-safes to prevent this type of malfunction, but the first, best defense against a runaway model is to always turn the transmitter on first, and off last.
- Always use new or freshly charged batteries for the radio system. Weak batteries will limit the radio signal between the receiver and the transmitter. Loss of the radio signal can cause you to lose control of your model.



- In order for the transmitter and receiver to bind to one another, the receiver in the model must be turned on within 20 seconds of turning on the transmitter. The transmitter LED will flash fast red indicating a failure to link. If you miss it, simply turn off the transmitter and start over.
- Always turn on the transmitter before plugging in the battery.

## RADIO SYSTEM BASIC ADJUSTMENTS

### Throttle Neutral Adjustment

The throttle neutral adjustment is located on the transmitter face and controls the forward/reverse travel of the throttle trigger. Change the adjustment by pressing the button and sliding it to the desired position. There are two settings available:



**50/50:** Allows equal travel for both acceleration and reverse.

**70/30:** Allows more throttle travel (70%) and less reverse travel (30%).

**Note:** We strongly recommend to leave this control in its factory location until you become familiar with all the adjustments and capabilities of your model. To change the throttle neutral adjust position, turn the transmitter off before adjusting the neutral position. You will need to reprogram your electronic speed control to recognize the 70/30 setting. Turn to ESC Setup Programming on page 17 for instructions.



### Steering Trim

The electronic steering trim located on the face of the transmitter adjusts the neutral (center) point of the steering channel.



### Multi-Function Knob

The Multi-Function knob can be programmed to control a variety of functions. From the factory, the Multi-Function knob controls steering sensitivity, also known as exponential or "expo." When the knob is turned counterclockwise all the way to the left (default position), expo is off and steering sensitivity will be linear (the most commonly used setting). Turning the knob clockwise will "add expo" and decrease the steering sensitivity in the initial range of steering wheel travel left or right from center. For more detail on steering exponential, refer to page 16.

## USING THE RADIO SYSTEM

The TQi Radio System has been pre-adjusted at the factory. The adjustment should be checked before running the model, in case of movement during shipping. Here's how:

1. Turn the transmitter switch on. The status LED on the transmitter should be solid green (not flashing).
2. Elevate the model on the included stand. Make sure your hands are clear of the moving parts of the model. **Keep fingers and objects away from the propeller!**
3. Plug the battery packs in the model into the speed control. This turns the speed control on.
4. Turn the steering wheel on the transmitter back and forth and check for rapid operation of the steering servo. Also, check that the steering mechanism is not loose or binding. If the steering operates slowly, check for weak batteries.
5. When looking down at the rear of model, the rudder should be pointing straight back. If the rudder is turned slightly to the left or right, slowly adjust the steering trim control on the transmitter until it is pointing straight back.
6. Gently operate the throttle trigger to ensure that you have forward and reverse operation, and that the motor stops when the throttle trigger is at neutral. **Warning: Do not apply full throttle in forward or reverse while the model is elevated.**
7. Once your adjustments have been made, turn the receiver and the model off by unplugging the batteries, then switch off the transmitter. The transmitter is always switched off last.



## Range-Testing the Radio System

Before each running session with your model, you should range-test your radio system to ensure that it operates properly.

1. Turn on the radio system and check its operation as described in the previous section.
2. Have a friend watch the model. **Make sure hands and clothing are clear of the propeller and other moving parts on the model.**
3. Walk away from the model with the transmitter until you reach the farthest distance you plan to operate the model.
4. Operate the controls on the transmitter once again to be sure that the model responds correctly.
5. Do not attempt to operate the model if there is any problem with the radio system or any external interference with your radio signal at your location.

## Higher Speeds Require Greater Distance

The faster you drive your model, the more quickly it will near the limit of radio range. At 50mph, a model can cover 73 feet every second! It's a thrill, but use caution to keep your model in range. If you want to see your model achieve its maximum speed, it is best to position yourself in the midpoint of the model's running area, not the far end, so you drive back and forth past your position. In addition to maximizing the radio's range, this technique will keep your model closer to you, making it easier to see and control.

## TQi Binding Instructions

For proper operation, the transmitter and receiver must be electronically "bound." **This has been done for you at the factory.** Should you ever need to re-bind the system or bind to an additional transmitter or receiver, follow these instructions. **Note:** The receiver must be connected to a 4.8-6.0v (nominal) power source for binding and the transmitter and receiver must be within 5 feet of each other.

1. Press and hold the transmitter's SET button as you switch transmitter on. The transmitter's LED will flash red slowly.
2. Press and hold the receiver's LINK button as you plug in the speed control.
3. When the transmitter and receiver's LEDs turn solid green, the system is bound and ready for use. Confirm that the steering and throttle operate properly before driving your model.



Remember, always turn the TQi transmitter on first and off last to avoid damage to your model.



### Automatic Fail-Safe

The TQi transmitter and receiver are equipped with an automatic fail-safe system that does not require user programming. In the event of signal loss or interference, the throttle will return to neutral and the steering will hold its last commanded position. If Fail-Safe activates while you are operating your model, determine the reason for signal loss and resolve the problem before operating your model again.



Stop immediately at the first sign of weak batteries. Never turn the transmitter off when the battery pack is plugged in. The model could run out of control.



### Setting Up the Antenna

The receiver antenna has been set up and installed from the factory. The antenna is secured by a 3x4mm set screw. To remove the antenna tube, simply remove the set screw with the included 1.5mm wrench.

When reinstalling the antenna, first slide the antenna wire into bottom of antenna tube until white tip of antenna is at top of tube under the black cap. Next insert the antenna tube into the mount while making sure that antenna wire is in slot in the antenna mount, then install the set screw next to the antenna tube. Use the supplied 1.5mm wrench to tighten the screw just until the antenna tube is securely in place. Do not over tighten. Do not bend or kink the antenna wire! Do not shorten the antenna tube.



To prevent loss of radio range do not kink or cut the black wire, do not bend or cut the metal tip, and do not bend or cut the white wire at the end of the metal tip.

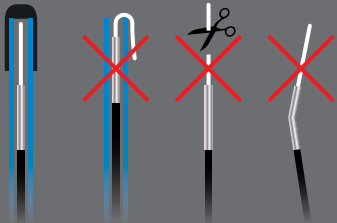

### Steering Sensitivity (Exponential)

The Multi-Function knob on the TQi transmitter has been programmed to control Steering Sensitivity (also known as exponential). The standard setting for Steering Sensitivity is “normal (zero exponential),” with the dial full left in its range of travel. This setting provides linear servo response: the steering servo’s movement will correspond exactly with the input from the transmitter’s steering wheel. Turning the knob clockwise from center will result in “negative exponential” and decrease steering sensitivity by making the servo less responsive near neutral, with increasing sensitivity as the servo nears the limits of its travel range. The farther you turn the knob, the more pronounced the change in steering servo movement will be. The term “exponential” comes from this effect; the servo’s travel changes exponentially relative to the input from the steering wheel. The exponential effect is indicated as a percentage—the greater the percentage, the greater the effect. The illustrations below show how this works.

### Normal Steering Sensitivity (0% exponential)

In this illustration, the steering servo’s travel (and with it, the steering motion of the model’s rudder) corresponds precisely with the steering wheel. The ranges are exaggerated for illustrative purposes.

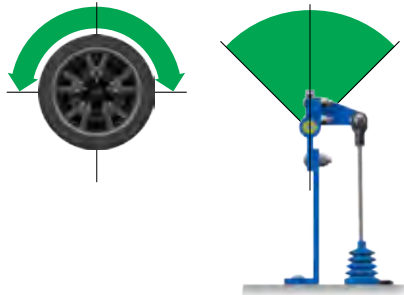

### Decreased Steering Sensitivity (Negative Exponential)

By turning the Multi-Function knob clockwise, the steering sensitivity of the model will be decreased. Note that a relatively large amount of steering wheel travel results in a smaller amount of servo travel. The farther you turn the knob, the more pronounced the effect becomes.

**Decreased steering sensitivity may be helpful when driving your model at high speeds, or anytime a less aggressive steering feel is desired.** The ranges are exaggerated for illustrative purposes.

Experiment! Try varying degrees of exponential. It’s easy to go back to “zero” if you don’t like the effect. There’s no wrong way to adjust exponential. Any setting that makes you more comfortable with your model’s handling is the “right setting.”

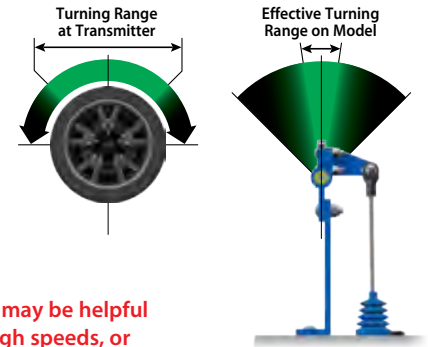



## ADJUSTING THE ELECTRONIC SPEED CONTROL

The VXL-6s Marine speed control is factory set and should not require any adjustments. These instructions are provided for your reference.

### Transmitter Adjustments for the VXL-6s Marine speed control

Before attempting to program your VXL-6s Marine electronic speed control (ESC), it is important to make sure that your transmitter is properly adjusted (set back to the factory defaults). Otherwise, you may not get the best performance from your ESC. Follow the steps below if your transmitter is not already adjusted as follows:

1. Turn transmitter off.
2. Hold both MENU and SET.
3. Turn transmitter on.
4. Release MENU and SET. The transmitter LED will blink red.
5. Press MENU once. The transmitter LED will blink red twice repeatedly.
6. Press SET to clear settings. The LED will glow green and the transmitter is restored to default.

### VXL-6s Battery Settings (Low-Voltage Detection Setting)

The Velineon VXL-6s Marine electronic speed control is equipped with built-in Low-Voltage Detection. The Low-Voltage Detection circuitry constantly monitors the battery voltage. When the battery voltage begins to reach the minimum recommended discharge voltage threshold for LiPo packs, the VXL-6s will limit power output to 25%. This allows sufficient power to return the model to shore. **Always return your model to shore and disconnect the batteries from your model as soon as Low-Voltage Detection limits power. Refer to page 24 for important details.**

The VXL-6s speed control's Low Voltage Detection has been set for best performance with the included battery. If your model included a NiMH battery, the speed control's LED will glow RED, indicating Low Voltage Detection is disabled. If your model included a LiPo battery, the speed control's LED will glow GREEN, indicating Low Voltage Detection is activated. **Never use LiPo batteries while Low-Voltage Detection is disabled.**

#### Verify Low-Voltage Detection setting:

1. Turn on the transmitter (with the throttle at neutral).
2. Connect two fully charged batteries to the VXL-6s.
3. If the ESC's LED glows red, then the Low-Voltage Detection is DISABLED (not safe to use LiPo batteries). If the LED glows green, then Low-Voltage Detection is ACTIVATED.

#### To activate Low-Voltage Detection (LiPo setting):

1. Turn on the transmitter and hold the trigger to full reverse.
2. While holding the trigger to full reverse, connect two fully charged batteries to the VXL-6s.
3. Continue to hold reverse. After about ten seconds, the red LED will go out and the green LED will switch on. You will also hear a 'rising' musical tone.

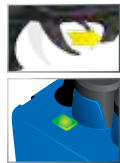

#### To disable Low-Voltage Detection (NiMH setting):

1. Turn on the transmitter and hold the trigger to full reverse.
2. While holding the trigger to full reverse, connect two fully charged batteries to the VXL-6s.
3. Continue to hold reverse. After about ten seconds, the green LED will go out and the red LED will switch on. You will also hear a 'falling' musical tone.



#### Setup Programming (Calibrating your ESC and transmitter)

Read through all of the following programming steps before you begin. If you get lost during programming or receive unexpected results, simply unplug the batteries, wait a few seconds, plug the batteries back in, and start over.

1. Place the boat on the included stand. **Always make sure that objects and fingers are clear of the prop.**
2. Turn on the transmitter. Pull and hold the trigger to full throttle.
3. While holding full throttle, connect two fully charged battery packs to the VXL-6s Marine ESC. It will turn on automatically.
4. Continue to hold the transmitter trigger at full throttle. After about two seconds, the ESC will beep once and its red LED will light. The full throttle position is now stored.
5. Move the trigger up to the full reverse position and hold it there. After about two seconds, you will hear two beeps and red LED will blink twice. The reverse throttle position has been stored.
6. Release the trigger so it is at the neutral position. The ESC will beep three times and the red LED will blink three times. After a short pause, the ESC will beep three more times and the LED will blink three times (red, red, green). The speed control is now programmed and ready for use.

#### VXL-6s Marine Operation

To operate the speed control and test the programming, place the boat on the included stand so the propeller is off the ground. **Always make sure that objects and fingers are clear of the prop.**

1. Turn the transmitter on.
2. Connect two fully charged batteries to the ESC. It will turn on automatically. The ESC will beep three times and blink three times (red, red, green). **Note: If Low Voltage Detection is enabled, the ESC will beep once and the green LED will blink once for each cell it detects before the three blinks and beeps. For example, if you are using a 4S LiPo, the green LED will blink four times and you will hear four beeps. Then it will beep and blink three more times.**
3. One LED will glow. If the red LED is glowing, it means Low-Voltage Detection has been switched off for use with NiMH batteries. The green LED will glow when Low-Voltage Detection is enabled, for use with LiPo batteries. **Low-Voltage Detection must be switched on when operating the model with LiPo batteries. See the Low-Voltage Detection Setting section for more information.**
4. Pull the transmitter's trigger toward the grip to apply forward throttle. The LED will go out, then glow at full throttle.



#### VXL-6s Marine Specifications:

##### Input voltage:

4.8-25.7V (6 to 18 cells NiMH or 2S to 6S LiPo)

##### Supported Motors:

Sensorless brushless

##### Motor limit:

None

##### Continuous current:

80A

##### Peak current:

300A

##### BEC voltage:

6.0V DC

##### Transistor type:

MOSFET

##### Battery connector:

Traxxas High-Current Connector

##### Motor connectors:

5.5mm bullet connectors

##### Motor/Battery Wiring:

13-gauge cable

##### Protection systems:

Low-Voltage Detection;  
Over Voltage; Thermal  
Overload; Throttle-Neutral  
Setting Protection

- Return the trigger to neutral and allow the prop to stop. Note that there is no programmed delay when changing from reverse to forward. Use caution to avoid slamming the speed control from reverse to forward and vice versa. This could result in driveline damage.
- Push the trigger away from the grip to apply reverse throttle. The LED will go out, then glow at full throttle. (Note that reverse throttle is only about 15% of forward throttle. This is normal.)
- To turn the speed control off, unplug the batteries.

**Thermal Shutdown Protection**

The VXL-6s Marine is equipped with thermal shutdown protection to guard against overheating caused by excessive current flow. If the operating temperature exceeds safe limits, the VXL-6s Marine will automatically shut down and the ESC's red LED will blink. The LED will continuously blink red, even if the throttle trigger is moved back and forth. After the ESC cools down to a safe level, the ESC will once again function normally.

**VXL-6s Marine Profile Selection**

The speed control is factory set to Profile 1. To change the profile, follow the steps on described below. The speed control should be connected to the receiver and the transmitter should be adjusted as described previously. The profiles are selected by entering the programming mode.

VXL-6s Marine Profile Description:

Profile 1 (Sport Mode): 100% Forward, 15% Reverse

Profile 2 (Race Mode): 100% Forward, No Reverse

Profile 3 (Training Mode): 50% Forward, 15% Reverse

**Selecting Sport Mode (Profile 1)**

- Place the boat on the included stand and make sure objects and fingers are clear of the propeller.
- Turn on the transmitter. Pull and hold the trigger to full throttle (A).
- While holding full throttle, connect two fully charged battery packs to the VXL-6s Marine ESC (B). It will turn on automatically.
- Continue to hold the transmitter trigger at full throttle. After about two seconds, the red LED will blink once and the ESC will beep once (C).
- Move the trigger to neutral (D). The ESC is ready for use and is set to Profile 1.

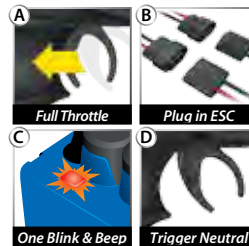

**Selecting Race Mode (Profile 2)**

- Place the boat on the included stand and make sure objects and fingers are clear of the propeller.
- Turn on the transmitter. Pull and hold the trigger to full throttle (A).

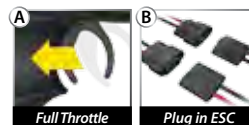

- While holding full throttle, connect two fully charged battery packs to the VXL-6s Marine ESC (B). It will turn on automatically.
- Continue to hold the transmitter trigger at full throttle. After about two seconds, the red LED will blink and the ESC will beep once (C).
- Continue to hold the transmitter trigger at full throttle. After about two more seconds (4 seconds total), the red LED will blink twice and the ESC will beep twice (D).
- Move the trigger to neutral (E). The ESC is ready for use and is set to Profile 2.

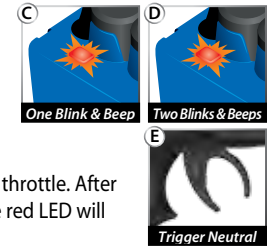

**Selecting Training Mode (Profile #3)**

- Place the boat on the included stand and make sure objects and fingers are clear of the propeller.
- Turn on the transmitter. Pull and hold the trigger to full throttle (A).
- While holding full throttle, connect two fully charged battery packs to the VXL-6s Marine ESC (B). It will turn on automatically.
- Continue to hold the transmitter trigger at full throttle. After about two seconds, the red LED will blink and the ESC will beep once (C).
- Continue to hold the transmitter trigger at full throttle. After about two more seconds (4 seconds total), the red LED will blink twice and the ESC will beep twice (D).
- Continue to hold the transmitter trigger at full throttle. After about two more seconds (6 seconds total), the red LED will blink three times and the ESC will beep three times (E).
- Move the trigger to neutral (F). The ESC is ready for use and is set to Profile 3.

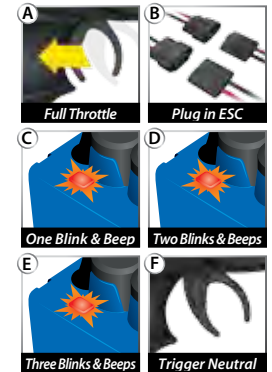

**Over-Voltage Detection**

The VXL-6s Marine speed control also detects when too much voltage is being input. If batteries with more than 25.2 volts are connected to the speed control, it will not operate. The red and green LEDs will blink, and an alternating high-low tone will sound. Unplug the batteries and install packs with 25.2 volts or less.

**Throttle Neutral Protection**

If the transmitter's throttle neutral position is moved after the VXL-6s speed control has been switched off, the speed control will not recognize the new position when it is turned back on and will not operate the throttle. This prevents the boat from running out of control due to an accidental change of the neutral position. If Throttle Neutral Protection detects that the throttle neutral position has changed, the VXL-6s speed control's green LED will blink and it will beep steadily. Return the throttle trim position to neutral to resume normal throttle operation.

Now it's time to have some fun! This section contains instructions on driving and making adjustments to your model. Before you go on, here are some important precautions to keep in mind.

- Use extra caution when traveling into the wind and/or against the direction of waves. The added pitch motion caused by driving into cresting waves, combined with wind blasts, tends to lift the boat out of the water further and might cause the boat to blow over backwards.
- If the boat starts getting very light on the water (about to blow over), reduce throttle to settle the hull back into the water.
- Always be ready to reduce the throttle if your model appears to be unstable or "chine walking" (rocking violently from side to side). Make trim tab or weight placement changes to reduce chine walking, as this behavior can cause a crash in rougher water.
- Always reduce the throttle when turning, especially in rough water. Once the boat has begun leaning into the corner, increase throttle to maintain speed and keep the bow up.
- Use caution when driving parallel to waves or wind chop. The waves will cause excess rocking, and may cause the boat to spin out or crash unexpectedly.
- When traveling at high speeds (40+ mph), be very gentle with control inputs to avoid hooking or flipping the boat.
- Avoid reversing for more than a few seconds at a time. Reversing causes water to rush over the stern of the boat and may cause it to sink.
- Drain the boat after every run. Even though every precaution has been made to keep water out of the hull, it may be necessary to drain any ingested water. Excess water in the hull will hurt performance and unbalance the boat.
- Do not leave the boat sitting in the water after each run. Water could enter the boat if the stuffing tube seal is worn.
- Do not operate the boat continuously at low speeds when using LiPo batteries. The ESC and motor could overheat from lack of cooling water flow.
- Remove the prop for transportation to avoid accidentally breaking it.
- Do not lift the boat by grabbing the sides of the hatch opening. This may cause the upper hull to tear. Use two hands to lift or handle the boat, grabbing the sides of the hull about 1/3 way up from the back.
- To prevent spin outs, avoid steering sharply at high speed.
- Jumping your model or towing anything with it should not be attempted.
- Return your model to shore at the first sign of weak batteries. Your model will begin to slow and the controls will become sluggish.

### Cavitation

If your model is running at full throttle but is only barely moving forward, the propeller is cavitating. Try advancing the throttle slowly to get your model on plane. If you are having trouble with cavitation, check the propellers for nicks or tangled debris. Your model's propeller is specially designed for its application and is very sensitive to any changes or modifications. If a prop is damaged, it should be replaced.

### Where to Run

Select a body of fresh water, which is calm and free of debris, tree stumps, moss, etc. Do not drive your model in extremely rough, choppy water or in high wind (more than 15mph); these conditions could cause your model to flip over. Also, find a clean, stable area of shoreline as a launch site. The water must be at least 10 inches deep. Be aware that some ponds restrict the use of model boats. Always choose a launch site that is downwind so that the wind and waves will drift the boat back to you if it should ever become disabled or capsize. **Running your model in salt water is not recommended. Damage from corrosion is not covered by the warranty. Your model is too fast to run in a swimming pool.**

### BOAT RETRIEVAL

**DANGER! DO NOT SWIM OR WADE INTO THE WATER TO RETRIEVE A BOAT.** If your model accidentally flips over and fills with water, it is equipped with foam flotation to help prevent it from sinking. If you have chosen your launch sight carefully (downwind), your model will probably drift back to you on its own. If there is no wind, you will need a tennis ball and a length of string. Tie the tennis ball securely to one end of the string and then throw the ball over the drifting boat. Pull the ball in and try to entangle the boat in the string. Pull the boat back slowly to shore. If only the bow of the boat remains visible, try using a fishing lure with many hooks and a fishing pole. Try to snag the lip of the upper deck or drive mechanism with the hooks.

### RUN TIME

Your model is able to achieve long run times due to the greater efficiency of the high voltage electrical system. A large factor affecting run time is the type and condition of your batteries. The milliamp hour (mAh) rating of the batteries determines how large their "fuel tank" is. A 3000 mAh battery pack will theoretically run twice as long as a 1500 mAh pack. Because of the wide variation in the types of batteries that are available and the methods with which they can be charged, it's impossible for us to give you exact run times for your model. Another major factor which affects run time is how your model is driven. Our experience has shown that the run times are shorter when the boat is driven continuously at top speed.

### Tips for Increasing Run Time

- Use a high-quality peak-detecting charger.
- Vary your speed. Continuous high speed shortens the run time on your model.
- Maintain your model. Do not allow debris or damaged parts to cause binding in the drivetrain. Keep the motor clean and the motor bearings lightly lubricated.
- Apply the throttle smoothly. Hard acceleration, especially from a stop, will shorten your run time.



**Caution!** If your model suddenly stops running or runs very slowly, release the throttle immediately! Refer to *Troubleshooting* on page 24 for more information.





**Optional Accessory: Machined Aluminum Trim Adjusters**  
For the most precise trim adjustments, Spartan can be outfitted with machined aluminum trim adjusters.



These install using the existing trim tab mounting holes, so no drilling is required. Once installed, the adjusters' stainless-steel screws can be used to make fine trim settings. Once Spartan is trimmed to your preference, corrosion-resistant nickel-plated nuts hold the adjustment. Refer to the parts list for more information and accessories.

## Adjusting the Trim Tabs

Spartan features stainless-steel trim tabs to help set the angle of the boat's hull as it rides in the water. Setting the trim angle correctly will provide maximum speed and efficiency from your model. From the factory, the trim tabs are set for best all-around performance and stability at Spartan's maximum speed, but you can experiment with their position to improve performance. Slightly bending the tabs down will cause the bow to run closer to the water, "wetting" more of the hull and increasing stability. Be sure to set the left and right trim tabs equally.

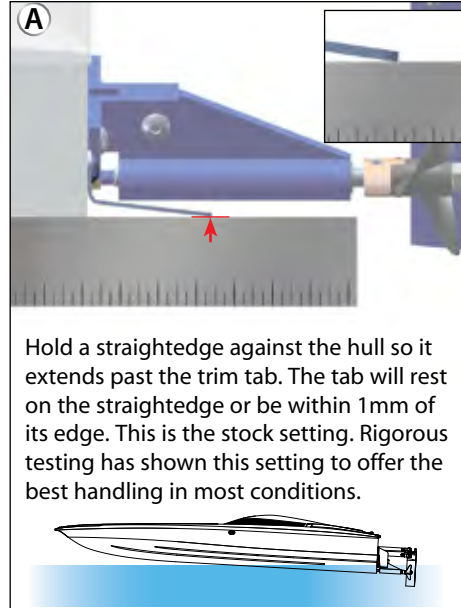

Hold a straightedge against the hull so it extends past the trim tab. The tab will rest on the straightedge or be within 1 mm of its edge. This is the stock setting. Rigorous testing has shown this setting to offer the best handling in most conditions.

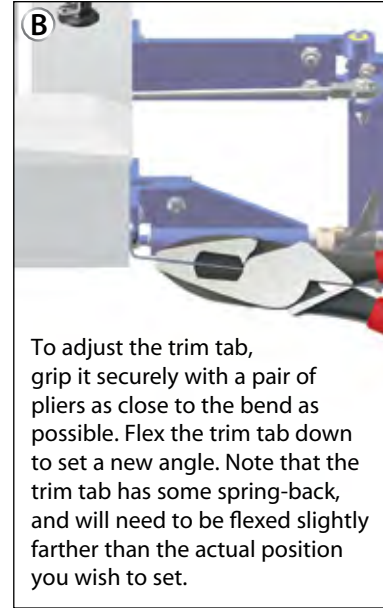

To adjust the trim tab, grip it securely with a pair of pliers as close to the bend as possible. Flex the trim tab down to set a new angle. Note that the trim tab has some spring-back, and will need to be flexed slightly farther than the actual position you wish to set.

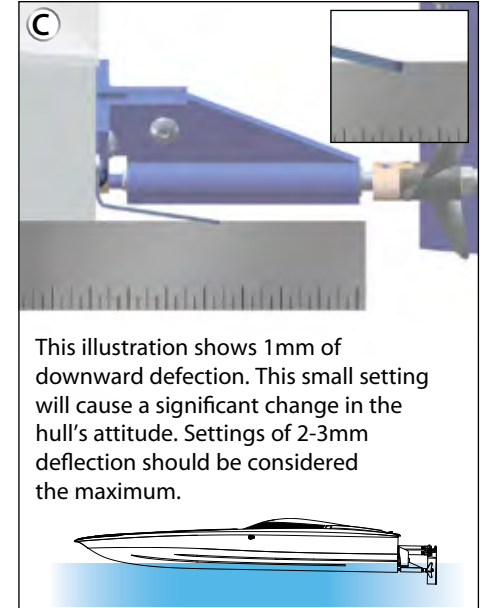

This illustration shows 1 mm of downward deflection. This small setting will cause a significant change in the hull's attitude. Settings of 2-3mm deflection should be considered the maximum.

## Adjusting the Rudder Angle

Spartan features an adjustable rudder support that permits the angle of the rudder to be changed to alter the model's cornering feel. The stock setting is 0°, or "vertical," meaning the rudder is parallel with the transom (see illustration). By loosening the rudder angle adjustment screws, the rudder can be pivoted back up to 3°. Altering the rudder angle effects how much the rudder "lifts" the hull while cornering. Increasing the rudder angle will allow the hull to ride higher while cornering, which may potentially raise cornering speeds but lessens stability. If you experiment with this feature, remember to retighten the adjustment screws after making your setting.

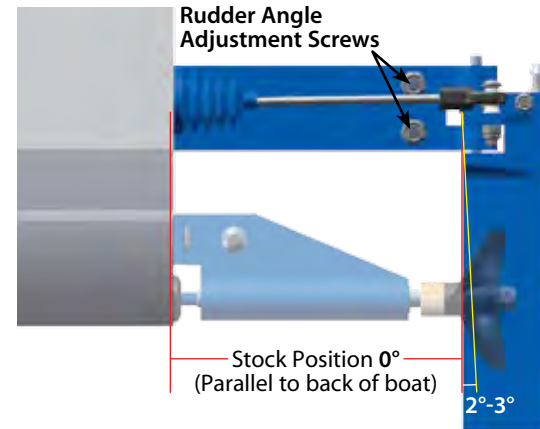

## Adjusting the Drive Strut

Spartan has a surface-piercing prop, meaning the prop is not fully submerged when the model is at speed. Varying the depth that the prop is submerged will alter the model's performance. The stock setting is 4mm above the lowest point of the hull. To adjust prop depth, loosen the drive strut adjustment screw and angle the strut down. The minimum setting is approximately 2mm above the bottom of the hull. Submerging more of the prop may increase speed with lower-voltage battery configurations, but amp draw will also be increased (the electronic speed control and batteries will have to "work harder," reducing battery life). For maximum performance with most battery configurations and in most conditions, the stock setting is best.

### Stock Setting

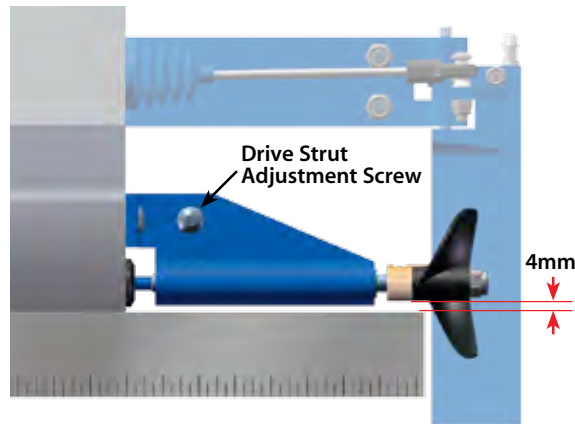

### Minimum Setting

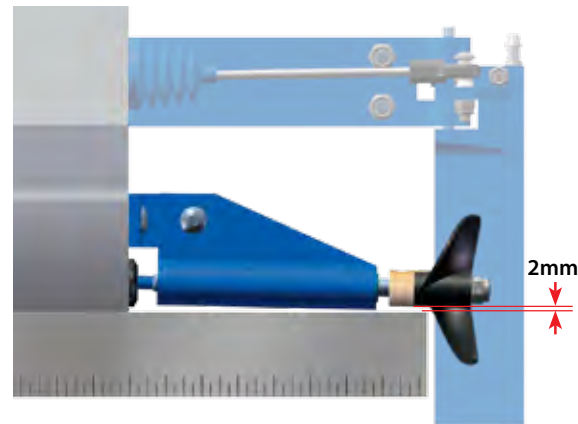

## RECEIVER BOX: MAINTAINING A WATERTIGHT SEAL

### Removing and Installing Radio Gear

The unique design of the receiver box allows the removal and installation of the receiver without losing the ability to maintain a watertight seal in the box. The patent-pending wire clamp feature gives you the ability to also install aftermarket radio systems and maintain the watertight features of the receiver box.

### Removing the Receiver

1. Remove the wire clamp by removing the two 2.5x8mm cap screws.
2. Remove the cover by removing the two 3x10mm cap screws.
3. To remove the receiver from the box, simply lift it out and set to the side. The antenna wire is still inside the clamp area and cannot be removed yet.
4. Unplug the servo cables from the receiver and remove the receiver.

### Receiver Installation

1. Install the electronic speed control (ESC), servo, and antenna wiring through the receiver box top (A). Make sure the box light pipe is aligned with the receiver LED.
2. Plug ESC and servo wires into the receiver (*see page 11*).

3. Bundle wiring as necessary.
4. Make sure the O-ring is properly seated into the groove in the receiver box bottom so that the cover will not pinch it or damage it in any way.
5. Place receiver box top onto receiver box bottom and install and tighten the two 3x10mm cap screws securely.
6. Inspect the cover to make sure that the O-ring seal is not visible.
7. Arrange the wires neatly using the wire guides on the receiver box top (B). Excess ESC and servo wiring should be bundled inside the receiver box. Pull out all available antenna wiring from the receiver box.
8. Apply a small bead of silicone grease to the foam on the wire clamp (C).
9. Install the wire clamp and tighten the two 2.5x8mm cap screws securely (D).





Always wear eye protection when using compressed air or spray cleaners and lubricants.

Water Cooling Diagram

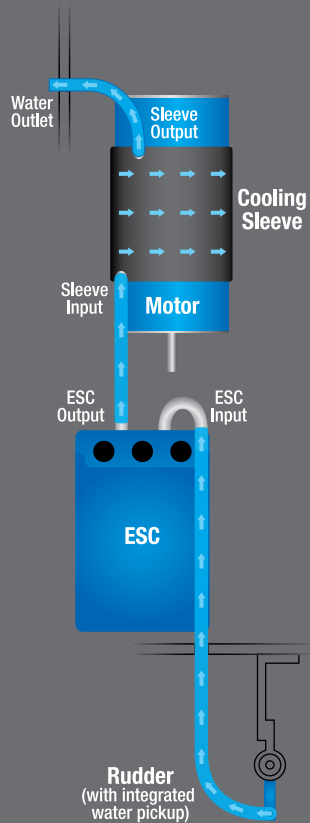

Your model requires maintenance in order to stay in top running condition. **The following procedures should be taken very seriously.** Form the habit of visually inspecting the mechanical integrity of the model before and after each run.

### Inspect the model for obvious damage or wear:

- Normally, some water will accumulate inside the boat. Empty any standing water out of the boat between runs. Pour any water out the side or back of the boat.
- Check the wiring for any frayed wires or loose connections.
- Check the tightness of the set screws in the collars on the steering linkages in the propeller. Thread-locking compound can be applied to these screws to prevent them from loosening.
- Check the mounting of the receiver and servo.
- Check the tightness of the propeller. Visually inspect the prop for nicks, dings, and warping. Replace if any damage is noticed.
- Check the operation of the radio system, especially the condition of the batteries.
- Visually inspect the hull for any cracks, damage, or possible leaks.
- Drain all water out of the model and thoroughly dry it before you store it. Store the model with the top deck removed so that any remaining moisture will evaporate.

### After each running session:

- Make certain the motor is completely dry, particularly the bearings.
- Lubricate the motor bearings with light oil.
- Release the drive cable from the collet as explained on page 23, and remove the drive cable by pulling the propeller away from the drive strut. Thoroughly dry the drive cable and lubricate it with the marine grease included with your model.
- While the drive cable is removed from the model, dry and lubricate the bushings in the drive strut. Reinstall the drive cable by reversing the removal steps.
- Keep all of the screws in the drive system tight.

### Storage:

- Disconnect and remove all batteries.
- Thoroughly clean and dry the model before storing it.
- Always store the model with the top deck cover removed. This will allow harmful moisture and condensation to evaporate.

### Centering your Servo

Whenever your radio system has been removed for service or cleaning, the steering servo must be re-centered prior to installing the radio system in the model.

1. If the radio system is already installed in the boat, disconnect the servo horn from the servo.
2. Connect the steering servo to channel 1 on your receiver and the electronic speed control to channel 2.
3. Place fresh "AA" batteries in the transmitter and turn the power switch on.
4. Turn the throttle and steering trim adjustments to the center position.
5. Keep fingers and objects away from the propeller. Connect two fresh battery packs to the electronic speed control. The servo will automatically jump to its center position.
6. The servo horn is now ready to be installed.
7. Be careful not to move the servo shaft when installing the linkages. Readjust the electronic speed control as described in the previous section.



### Radio Tray Removal

Spartan's unique power module allows you to easily remove the motor, drive system, and electronics as a unit for easy access to the hull interior. With the power module removed, you can easily work on the drive system or electronics without the entire hull taking up your bench space. To remove the power module, follow these steps:

1. Loosen the drive cable collet. Using the two 10mm wrenches supplied, grip the collet base and collet clamp. Rotate the parts away from each other in the direction shown to loosen the clamp. You do not have to fully unthread the collet, it will take less than one full rotation to loosen the clamp.

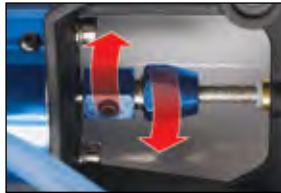

2. Remove the drive cable. Pull the propeller away from the drive strut. The cable will come out with the propeller. There is no need to remove the prop from the cable.
3. Remove the steering linkage. Use the supplied 2.5mm wrench to unthread the 15mm screw in the servo arm and disengage the steering linkage.
4. Unplug the water cooling outlet tube (A) and inlet tube (B).
5. Loosen the retaining screws. Use the supplied 2.5mm wrench to loosen the screws approximately 5 full turns. It is not necessary to remove these screws, only loosen them.
6. Gently lift the power module from the motor end. If it does not release easily from the hull rails, loosen the retaining screws another turn.
7. Slide the power module forward. Gently pull on the module to slide the tabs out of the slots in the hull rails.

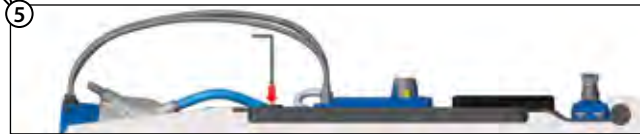

**Note:** Sometimes the stuffing tube sticks in the seal. Extra force may be required to break it free.

## TROUBLESHOOTING

The following section addresses some very basic questions you may have about your model. If you can't find a solution here, you may call Traxxas Customer Service at 1-888-TRAXXAS (U.S. residents only).

### If the model stopped suddenly:

- Release the transmitter trigger immediately. Do not try and "force" the model to move. Refer to the *Boat Retrieval* section on page 19 for recovery.

### If there is an inconsistent reduction in power:

- There could be something wound around the prop (such as trash, algae or fishing line). If you continue to drive your model with a bound prop, the high load could create excessive heat and seriously damage the batteries, speed control, or motor. Refer to the *Boat Retrieval* section on page 19 for recovery.
- The model might have struck an object in the water causing driveline damage. Refer to the *Boat Retrieval* section on page 19 for recovery.

### If there is an immediate reduction in power:

- If the model's power output is reduced suddenly, it is likely because the Low-Voltage Detection system has switched on.
- **Low-Voltage Detection** will reduce power output to 25%. This allows sufficient power to return the model to shore. To prevent over-discharging your LiPo battery after Low-Voltage Detection limits power, return your model to shore and disconnect the LiPo pack(s) from the model immediately. Low-Voltage Detection allows operation with limited power for returning to shore ONLY. Operating the model longer than necessary to return to shore may cause over-discharging and permanent damage to LiPo batteries. ***Always return your model to shore and disconnect the batteries from your model as soon as Low-Voltage Detection limits power.*** The LED on the speed control will slowly blink red, indicating a low voltage shutdown. The VXL-6s will stay in the reduced power mode until a fully charged battery is connected.
- If you are not sure if the above condition occurred, **do not operate the model.** Refer to the *Boat Retrieval* section on page 19 for recovery.

## INCREASING PERFORMANCE

While your model is a great performer out of the box, there are steps you can take to increase the speed of the boat.

1. **Adjust the trim tab angle correctly.** The trim tab angle should be trimmed down just enough to keep the bow of the boat from porpoising (bouncing up and down) in the current water conditions. If the trim tabs are set too low, then it pushes the bow lower and increases drag in the water (see page 20).
2. **Maintain your boat.** Your model will be faster if it is kept clean and in good working order. Replace the prop if it gets nicked or damaged. Keep the motor clean and oiled. Make sure the drivetrain turns freely with no binding or excess friction.

3. **Use the best batteries and charger you can afford.** Low-cost, low-capacity battery packs will limit the performance of your model. Likewise, a low-cost charger may not allow your batteries to achieve their peak power and capacity. For best performance, use battery packs rated for 3000mAh or higher. Traxxas Power Cell battery packs are specially constructed for durability and performance in high-power Traxxas models. Traxxas recommends the EZ-Peak Dual iD charger, part #2972, for quick charging of the included batteries. See Traxxas.com for more information.

### Using Aftermarket Props

Spartan's included prop has been carefully designed for maximum performance and durability. It does not require sharpening or balancing and is inexpensive to replace if damaged. If you do wish to experiment with aftermarket props, Traxxas recommends using props that range in diameter from 38-42mm, with a pitch-to-diameter ratio of about 1.4:1. To determine this ratio, divide pitch by diameter. For example, the Spartan's stock prop is 42mm in diameter with a pitch of 59mm ( $59 \div 42 = 1.404$ ). Avoid props larger than 42mm, as these will increase amp draw and reduce performance.

### Using Aftermarket Motors and Speed Controls

**Important:** The VXL-6s Marine Speed Control and 540XL Brushless Motor have been optimized to work together for the absolute best performance, reliability, and efficiency. Using an aftermarket motor with the VXL-6s speed control, or an aftermarket speed control with the 540XL Brushless Motor, may result in damage to the Traxxas components and/or aftermarket components. Damage incurred by mixing Traxxas and aftermarket components will not be covered by any expressed or implied warranty. Only use the VXL-6s Marine speed control with the 540XL Brushless Motor.

If you wish to outfit your model with an aftermarket brushless system, you must replace both the motor and the speed control. Traxxas recommends a motor with a kV rating of 1600-1800 kV. Make certain the speed control you choose is compatible with your motor, is designed for marine use, and is waterproof. Water cooling is highly recommended. Additional silicone tubing may be required to properly plumb your speed control's water-cooling system. The Traxxas water-cooling motor jacket is not compatible with all motors. Install an appropriate water-cooling system for the motor you choose. Traxxas is not responsible for damage to your model or the components you install in the model if you replace the power system with non-Traxxas components.

*For the best performance, we highly recommend the Spartan's factory-installed brushless system. It is optimized for the best performance, reliability, and ease of use in the Spartan, and fully supported by Traxxas customer service.*

If you have questions or need technical assistance, call Traxxas at

**1-888-TRAXXAS**

(1-888-872-9927) (U.S. residents only)



Your Traxxas transmitter has a programmable Multi-Function knob that can be set to control various advanced transmitter functions (set to Steering Sensitivity by default, see page 16). Access the programming menu by using the MENU and SET buttons on the transmitter and observing signals from the LED. An explanation of the menu structure follows on page 27. Experiment with the settings and features to see if they can improve your driving experience.

### Throttle Sensitivity (Throttle Exponential)

The Multi-Function knob can be set to control Throttle Sensitivity. Throttle Sensitivity works the same way as Steering Sensitivity as described on page 16, but applies the effect to the throttle channel. Only forward throttle is affected; brake/reverse travel remains linear regardless of the Throttle Sensitivity setting.

### Steering Percentage (Dual Rate)

The Multi-Function knob can be set to control the amount (percentage) of servo travel applied to steering. Turning the Multi-Function knob fully clockwise will deliver maximum steering throw; turning the knob counter-clockwise reduces steering throw (note: turning the dial counter-clockwise to its stop will eliminate all servo travel). Be aware that the steering End Point settings define the servo's maximum steering throw. If you set Steering Percentage to 100% (by turning the Multi-Function knob fully clockwise), the servo will travel all the way to its selected end point, but not past it. Many racers set Dual Rate so they have only as much steering throw as they need for the tightest turn, thus making the vehicle easier to drive throughout the rest of the course. Reducing steering throw can also be useful in making a car or truck easier to control on high-traction surfaces, and limiting steering output for oval racing where large amounts of steering travel are not required.

### Throttle Trim

Setting the Multi-Function knob to serve as throttle trim will allow you to adjust the throttle's neutral position to prevent unwanted brake drag or throttle application when the transmitter trigger is at neutral. **Note:** Your transmitter is equipped with a Throttle Trim Seek mode to prevent accidental runaways. See the sidebar for more information.

### Steering and Throttle Sub-Trim

The Sub-Trim function is used to precisely set the neutral point of the steering or throttle servo in the event that simply setting the trim knob to "zero" does not completely center the servo. When selected, Sub-Trim allows finer adjustment to the servo output shaft's position for precise setting of the neutral point. Always set the Steering Trim knob to zero before making final adjustment (if required) using Sub-Trim. If Throttle Trim has been previously adjusted, the Throttle Trim will need to be reprogrammed to "zero" before making final adjustment using Sub-Trim.

### Steering and Throttle End Points

The TQi transmitter allows you to choose the limit of the servo's travel range (or its "end point") independently for left and right travel (on the steering channel) and throttle/brake travel (on the throttle channel). This allows you to fine-tune the servo settings to prevent binding caused by the servo moving steering or throttle linkages (in the case of a nitro vehicle) farther than their mechanical limits. The end point adjustment settings you select will represent what you wish to be the servo's maximum travel; the Steering Percentage or Braking Percentage functions will not override the End Point settings.

### Setting Lock

Once you've adjusted all of these settings the way you like them, you may want to disable the Multi-Function knob so none of your settings can be changed. This is especially handy if you operate multiple vehicles with a single transmitter via Traxxas Link™ Model Memory.

### Multiple Settings and the Multi-Function Knob

It is important to note that settings made with the Multi-Function knob are "overlaid" on top of each other. For example, if you assign the Multi-Function to adjust Steering Percentage and set it for 50%, then reassign the knob to control Steering Sensitivity, the transmitter will "remember" the Steering Percentage setting. Adjustments you make to Steering Sensitivity will be applied to the 50% steering throw setting you selected previously. Likewise, setting the Multi-Function knob to "disabled" will prevent the knob from making further adjustments, but the last setting of the Multi-Function knob will still apply.

### Braking Percentage

R/C boats do not have brakes, as the natural resistance of the water will slow and stop the boat when the throttle is shut off; however, if you use your TQi transmitter with a car or truck, you may find the Braking Percentage function useful. When set for Braking Percentage, the Multi-Function knob will control the amount of brake travel applied by the throttle/brake servo in a nitro-powered model. Electric models do not have a servo-operated brake but the Braking Percentage function still operates the same way in electric models. Turning the Multi-Function knob full clockwise will deliver maximum brake throw; turning the knob counter-clockwise reduces brake throw. **Note:** Turning the dial counter-clockwise to its stop will eliminate all brake action.

### TRAXXAS LINK MODEL MEMORY

Traxxas Link Model Memory is an exclusive, patent-pending feature of the TQi transmitter. Each time the transmitter is bound to a new receiver, it saves that receiver in its memory along with all the settings assigned to that receiver. When the transmitter and any bound receiver are switched on, the transmitter automatically recalls the settings for that receiver. There is no need to manually select your vehicle from a list of model memory entries.



#### Starting Over:

#### Restoring Factory Defaults

When programming your TQi transmitter, you may feel the need to start over with a clean slate. Follow these simple steps to restore the factory settings:

1. Turn transmitter off.
2. Hold both MENU and SET.
3. Turn transmitter on.
4. Release MENU and SET. The transmitter LED will blink red.
5. Press MENU once. The transmitter LED will blink red twice repeatedly.
6. Press SET to clear settings. The LED will turn solid green and the transmitter is restored to default.



#### Throttle Trim Seek Mode

When the Multi-Function knob is set to throttle trim, the transmitter remembers the throttle trim setting. If the throttle trim knob is moved from the original setting while the transmitter is off, or while the transmitter was used to control another model, the transmitter ignores the actual position of the trim knob. This prevents the model from accidentally running away. The LED on the face of the transmitter will rapidly blink green and the throttle trim knob (Multi-Function knob) will not adjust the trim until it is moved back to its original position saved in memory. To restore throttle trim control, simply turn the multi-function knob either direction until the LED stops blinking.

**Failsafe**

Your Traxxas radio system is equipped with a built-in failsafe function that returns the throttle to its last saved neutral position in the event of a signal loss. The LED on the transmitter and the receiver will rapidly flash red.

**Model Lock**

The Traxxas Link Model Memory feature can store up to thirty models (receivers) in its memory. If you bind a thirty-first receiver, Traxxas Link Model Memory will delete the “oldest” receiver from its memory (in other words, the model you used the longest time ago will be deleted). Activating Model Lock will lock the receiver in memory so it cannot be deleted.

You may also bind multiple TQi transmitters to the same model making it possible to pick up any transmitter and any previously bound model in your collection and simply turn them on and drive. With Traxxas Link Model Memory, there is no need remember which transmitter goes with which model and there is never a need to have to select any model from a list of model memory entries. The transmitter and receiver do it all for you automatically.

**To activate Model Lock:**

1. Switch on the transmitter and receiver you wish to lock.
2. Press and hold MENU. Release when the status LED blinks green.
3. Press MENU three times. The status LED will blink green four times repeatedly.

4. Press SET. The status LED will blink green in single-flash intervals.
5. Press SET once. The status LED will blink red once repeatedly.
6. Press MENU once, the LED will blink red twice repeatedly.
7. Press SET, the LED will blink rapidly green. The memory is now locked. Press and hold MENU to return to driving mode.

**Note:** To unlock a memory, press SET twice at step 5. The LED will blink rapidly green to indicate the model is unlocked. To unlock all models, press MENU twice at step 6 and then press SET.

**To delete a model:**

At some point, you may wish to delete a model you no-longer drive from the memory.

1. Switch on the transmitter and receiver you wish to delete.
2. Press and hold MENU. Release when the status LED blinks green.
3. Press MENU three times. The status LED will blink green four times repeatedly.
4. Press SET once. The status LED will blink green once repeatedly.
5. Press MENU once. The status LED will blink green twice repeatedly.
6. Press SET. The memory is now selected to be deleted. Press SET to delete the model. Press and hold MENU to return to driving mode.

**TRANSMITTER LED CODES**

LED Color / Pattern	Name	Notes	
	Solid green	Normal Driving Mode	See page 14 for information on how to use your transmitter controls.
	Slow red (0.5 sec on / 0.5 sec off)	Binding	See page 15 for more information on binding.
	Flashing fast green (0.1 sec on / 0.15 sec off)	Throttle Trim Seek Mode	Turn the Multi-Function knob right or left until the LED stops flashing. See page 25 for more information.
	Flashing medium red (0.25 sec on / 0.25 sec off)	Low Battery Alarm	Put new batteries in the transmitter. See page 12 for more information.
	Flashing fast red (0.125 sec on / 0.125 sec off)	Link Failure / Error	Transmitter and receiver are no longer bound. Turn the system off and then back on to resume normal operation. Find source of the link failure (ie out of range, low batteries, damaged antenna).
<b>Programming Patterns</b>			
	Counts out number (green or red) then pauses	Current menu position	See Menu Tree for more information.
X 8	Fast green 8 times	Menu setting accepted (on SET)	
X 8	Fast red 8 times	Menu SET invalid	User error such as trying to delete a locked model.

**RECEIVER LED CODES**

LED Color / Pattern	Name	Notes	
	Solid green	Normal Driving Mode	See page 14 for information on how to use your transmitter controls.
	Flashing slow red	Binding	See page 15 for more information on binding.
	Flashing medium red	Fail-Safe / Low-Voltage Detect	Consistent Low-Voltage in the receiver triggers Fail-Safe so there is enough power to center the throttle servo before it completely loses power.

**MENU TREE**

The menu tree below shows how to navigate through the TQi transmitter's various settings and functions. Press and hold MENU to enter the menu tree, and use the following commands to navigate through the menu and select options.

**MENU:** When you enter a menu, you always start at the top. Press MENU to move down the menu tree. When you reach the bottom of the tree, pressing MENU again will return you to the top.

**SET:** Press SET to move across the menu tree and select options. When an option is committed to the transmitter's memory, the status LED will rapidly blink green.

**BACK:** Press both MENU and SET to go back one level in the menu tree.

**EXIT:** Press and hold MENU to exit programming. Your selected options will be saved.

**ECHO:** Press and hold SET to activate the "echo" function. Echo will "play back" your current position on the Menu Tree, should you lose your place. For example: If your current position is Steering Channel End Points, holding SET will cause the LED to blink green twice, green once, and then red three times. Echo will not alter your adjustments or change your position in the programming sequence.

Below is an example of how to access a function in the menu tree. In the example, the user is setting the Multi-Function knob to be a steering Dual Rate control.

- To set the Multi-Function knob to control STEERING DUAL RATE (%):
1. Switch the transmitter on
  2. Press and hold MENU until the green LED lights. It will blink in single intervals.
  3. Press SET. The red LED will blink in single intervals to indicate Steering Dual Rate has been selected.
  4. Press MENU twice. The red LED will blink three times repeatedly to indicate Steering Percentage has been selected.
  5. Press SET to select. The green LED will blink 8 times fast to indicate successful selection.
  6. Press and hold MENU to return to driving mode.

**Restoring Factory Defaults:**

Transmitter OFF	Hold both MENU and SET	Transmitter ON	Release MENU and SET red LED blinks	Press MENU once. The transmitter LED will blink red twice repeatedly.	Press SET to clear settings. LED will turn solid green. Transmitter is restored to default
-----------------	------------------------	----------------	--	---	--

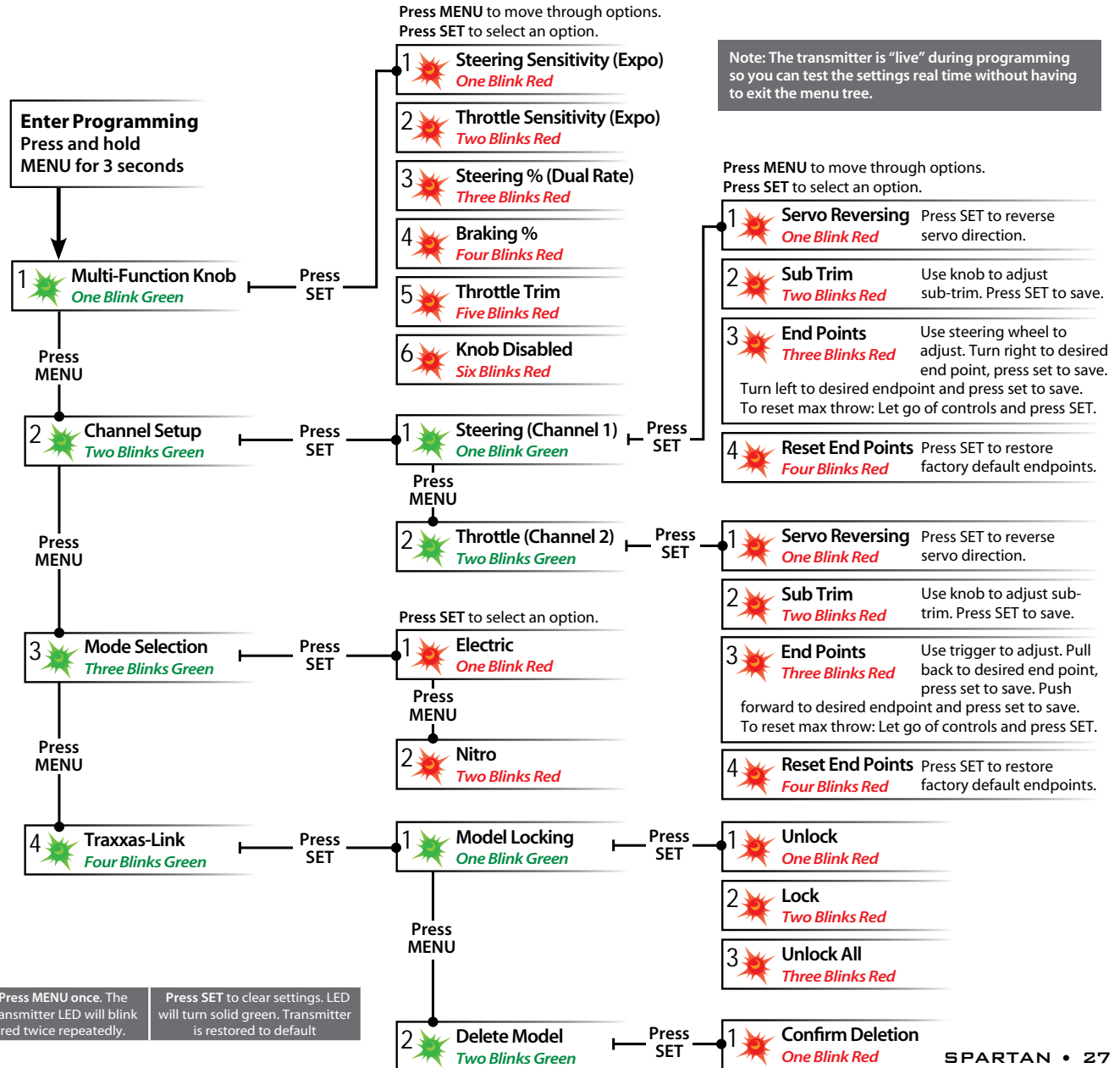

Set Multi-Function knob for STEERING SENSITIVITY (Expo)	Press/hold MENU green LED blinks	Press SET red LED blinks	x8 Press SET to confirm green LED blinks (x8)	Press/hold MENU returns to driving mode								
Set Multi-Function knob for THROTTLE SENSITIVITY (Expo)	Press/hold MENU green LED blinks	Press SET red LED blinks	x2 Press MENU to confirm red LED blinks (x2)	x8 Press SET to select green LED blinks (x8)	Press/hold MENU returns to driving mode							
Set Multi-Function knob for STEERING DUAL RATE (%)	Press/hold MENU green LED blinks	Press SET red LED blinks	x3 Press MENU twice red LED blinks (x3)	x8 Press SET to select green LED blinks (x8)	Press/hold MENU returns to driving mode							
Set Multi-Function knob for BRAKING PERCENTAGE (%)	Press/hold MENU green LED blinks	Press SET red LED blinks	x4 Press MENU 3 times red LED blinks (x4)	Press SET to select green LED blinks (x8)	Press/hold MENU returns to driving mode							
Set Multi-Function knob for THROTTLE TRIM	Press/hold MENU green LED blinks	Press SET red LED blinks	x5 Press MENU 4 times red LED blinks (x5)	x8 Press SET to select green LED blinks (x8)	Press/hold MENU returns to driving mode	Adjust the Multi-Function knob until the LED turns solid green.						
To LOCK the Multi-Function knob	Press/hold MENU green LED blinks	Press SET red LED blinks	x6 Press MENU 5 times red LED blinks (x6)	x8 Press SET to lock green LED blinks (x8)	Press/hold MENU returns to driving mode							
To REVERSE the direction of STEERING servo	Press/hold MENU green LED blinks	x2 Press MENU green LED blinks (x2)	Press SET green LED blinks	Press SET red LED blinks	x8 Press SET to reverse servo direction	Press/hold MENU returns to driving mode						
To set the SUB TRIM of the STEERING servo	Press/hold MENU green LED blinks	x2 Press MENU green LED blinks (x2)	Press SET green LED blinks	Press SET red LED blinks	x2 Press MENU red LED blinks (x2)	Use Multi-Function knob to set neutral	x8 Press SET to save position	Press/hold MENU returns to driving mode				
To set the END POINTS of the STEERING servo	Press/hold MENU green LED blinks	x2 Press MENU green LED blinks (x2)	Press SET green LED blinks	Press SET red LED blinks	x3 Press MENU twice red LED blinks (x3)	Turn steering wheel to desired max left and right travel	x8 Press SET to save each position	Turn steering wheel to test settings	IF END POINTS ARE OK: Press/hold MENU returns to driving mode	IF END POINTS NEED TO BE CHANGED: Press SET and repeat steps 6-8		
To reset the END POINTS of STEERING servo to defaults	Press/hold MENU green LED blinks	x2 Press MENU green LED blinks (x2)	Press SET green LED blinks	Press SET red LED blinks	x4 Press MENU 3 times red LED blinks (x4)	x8 Press SET to reset end points	Press/hold MENU returns to driving mode					
To REVERSE the direction of THROTTLE servo	Press/hold MENU green LED blinks	x2 Press MENU green LED blinks (x2)	Press SET green LED blinks	x2 Press MENU green LED blinks (x2)	Press SET red LED blinks	x8 Press SET to reverse servo direction	Press/hold MENU returns to driving mode					
To set the SUB TRIM of the THROTTLE servo	Press/hold MENU green LED blinks	x2 Press MENU green LED blinks (x2)	Press SET green LED blinks	x2 Press MENU green LED blinks (x2)	Press SET red LED blinks	x2 Press MENU red LED blinks (x2)	Use Multi-Function knob to set neutral	x8 Press SET to save position	Press/hold MENU returns to driving mode			
To set the END POINTS of the THROTTLE servo	Press/hold MENU green LED blinks	x2 Press MENU green LED blinks (x2)	Press SET green LED blinks	x2 Press MENU green LED blinks (x2)	Press SET red LED blinks	x3 Press MENU twice red LED blinks (x3)	Use throttle trigger to set desired max throttle or brake	Press SET to save Use trigger to test	IF END POINTS ARE OK: Press/hold MENU returns to driving mode	IF END POINTS NEED TO BE CHANGED: Press SET and repeat steps 7-9		
To reset the END POINTS of THROTTLE servo to defaults	Press/hold MENU green LED blinks	x2 Press MENU green LED blinks (x2)	Press SET green LED blinks	x2 Press MENU green LED blinks (x2)	Press SET red LED blinks	x4 Press MENU 3 times red LED blinks (x4)	x8 Press SET green LED blinks (x8)	Press/hold MENU returns to driving mode				

### MENU TREE FORMULAS

To select functions and make adjustments to the TQi transmitter without referencing the menu tree, turn your transmitter on, find the function in the left column you wish to adjust, and simply follow the corresponding steps.



Always turn your transmitter on first.

## PROGRAMMING YOUR TQi TRANSMITTER WITH YOUR APPLE IPHONE, IPAD, IPOD TOUCH, OR ANDROID MOBILE DEVICE

The Traxxas Link™ Wireless Module (part #6511, sold separately) for the TQi transmitter installs in minutes to transform your Apple® iPhone®, iPad®, iPod touch®, or Android™ device into a powerful tuning tool that allows you to replace the transmitter's button/LED programming system with an intuitive, high-definition, full-color graphical user interface.



### Traxxas Link

The powerful Traxxas Link app (available in the Apple App Store™ or on Google Play™) gives you complete control over the operation and tuning of your Traxxas model with stunning visuals and absolute precision. Install Traxxas Link telemetry sensors on the model, and Traxxas Link displays real-time data such as speed, RPM, temperature, and battery voltage.



Compatible with:  
iPod touch (5th generation and later)  
iPad (3rd generation and later)  
iPad mini

iPhone 4S  
iPhone 5  
iPhone 5C  
iPhone 5S

Intuitive iPhone, iPad, iPod touch, and Android interface Traxxas Link makes it easy to learn, understand, and access powerful tuning options. Control Drive Effects settings such as steering and throttle sensitivity; steering percentage; braking strength; and throttle trim by simply touching and dragging the sliders on the screen.



Tap and slide to adjust Steering Sensitivity, Throttle Trim, Braking Percent, and more!

### Real-Time Telemetry

When you equip your model with sensors, the Traxxas Link dashboard comes to life showing you speed, battery voltage, RPM, and temperature. Set threshold warnings and log maximums, minimums, or averages. Use the recording function to document your dashboard view, with sound, so that you can keep your eyes on your driving and not miss a single apex.



The customizable Traxxas Link dashboard delivers real-time rpm, speed, temperature, and voltage data.

### Manage up to 30 Models with Traxxas Link

The TQi radio system automatically keeps track of what vehicles it has bound to and what settings were used for each--up to 30 models total! Traxxas Link provides a visual interface to name the models, customize their settings, attach profiles, and lock them into memory. Simply choose a model and any previously bound transmitter, power them up, and start having fun.



Traxxas Link Model Memory simplifies organizing your collection of vehicles.

**i** The Traxxas Link Wireless Module is sold separately (part #6511). The Traxxas Link application is available from the Apple App store for iPhone, iPad, or iPod touch and on Google Play for Android devices. iPhone, iPad, iPod touch, or the Android device are not included with the Traxxas Link Wireless Module.

For more information about the Traxxas Link Wireless Module and the Traxxas Link application, visit [Traxxas.com](http://Traxxas.com).

**Download Now!**



**TRAXXAS LINK**

Available on the **App Store**

ANDROID APP ON **Google play**

Apple, the Apple logo, iPhone, iPad, and iPod touch are trademarks of Apple Inc., registered in the U.S. and other countries. App Store is a service mark of Apple Inc. Android and Google Play are trademarks of Google Inc.



# SPARTAN™

OWNER'S MANUAL

MODEL 57076-1

**TRAXXAS**

6250 TRAXXAS WAY, MCKINNEY, TEXAS 75070  
1-888-TRAXXAS